

2599 8/16/32-Point AC Discrete Output Module

Classic

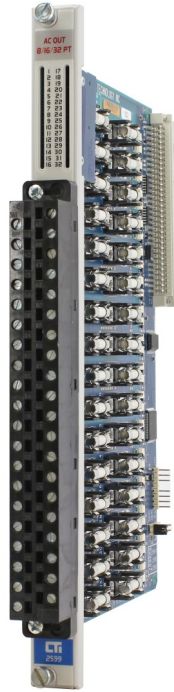

Description

Module provides up to thirty-two outputs from the CTI 2500 Series® or Simatic® 505 I/O base. The module utilizes solid-state output circuits to switch on or off external devices such as pilot lamps, motor starters, or solenoids. The 2599 is designed to switch externally supplied 11 to 240 VAC. The internal logic signals are isolated from the external outputs to 2100 VDC.

Features

- 8, 16, or 32 AC output points
- Replaces Siemens® 505-4608, -4616, -4632, -4808, -4816, -4832
- 3000 VDC group-to-group isolation
- 2100 VDC channel-to-backplane isolation
- Isolation in groups of 4 or 8 (selectable with 32 pt login configuration)
- Wide 11-240 VAC output range
- 2.0A per output (32 Amps total module output)
- Individually fused outputs
- Sourcing outputs
- Single-wide module

Specifications

Outputs per Module: 8, 16, or 32

Isolation:

2100 VAC channel-to-backplane
3000 VAC group-to-group

Output Voltage: 11 VAC to 240 VAC

Maximum Output Current:

2A per point
8A per group
32A per module (32pt login)

for Class 1 Div 2 locations:

2A per point @ 50C
1.5A per point @ 60C

Maximum Surge Current: 3 Amps for 15 Sec

“ON” State Voltage Drop: 1.0 V @ 1.0 Amp

“OFF” State Leakage Current: 1 mA @ 120 VAC

Turn On Time: 1 AC cycle

Turn Off Time: 1 AC cycle

⚠ Fuses:

32, 2.5 amp, 250V, Type Littlefuse #21602.5,
Bussman GDA-2.5, (Field replaceable)

Connector: Removable 2500-40F

Wire Gauge: 14 - 22 AWG

Backplane Power: 1.75 Watts max.

Module Size: Single-wide

Shipping Weight: 1.5 lb. (0.68 Kg)

Additional Product Information:

On CTI's Website you find will links to the 2500 Series Std Environmental Specifications and the UL Agency Certificates of Compliance .



Control Technology Inc.

5734 Middlebrook Pike, Knoxville, TN 37921-5962
Phone: +1.865.584.0440 Fax: +1.865.584.5720
www.controltechnology.com

ROCK SOLID PERFORMANCE. TIMELESS COMPATIBILITY.

2599 8/16/32-Point AC Discrete Output Module

32 Pt Mode: 8 Common Configuration

The module can also be configured so that eight channels share a common user power. The same jumpers mentioned above, J2, J4, J5, and J6, are used for this selection. In this example, if jumper J2 was placed in the 8 Common position, then Channels 1-8 would share the same common user power and only one supply voltage could be used on these eight channels. With this selection each group of eight channels is isolated from the other, allowing up to four different supply voltages to be accommodated per module. The module ships in this configuration.

32-Point Mode: 4 Common Configuration

The user may configure the module to allow four channels to be grouped and share a common field user power, thereby allowing a different user power supply voltage to be used by each grouping. Jumpers J2, J4, J5, and J6 are used to configure this selection. For example, if the user places the J2 jumper in the 4 Common position, Channels 1-4 will share a common user power and Channels 5-8 will share another common user power. In this example each group of four channels is isolated from the other group of four channels. Because each group of four is isolated, the user may also change the supply voltage for each group. So, in this example, Channels 1-4 could be 240VAC outputs and Channels 5-8 could be 120VAC outputs. Furthermore, the user may select a different configuration for J4, J5, or J6, allowing for further combinations of four or eight channels that share a common.

16 Point Mode:

Move jumper in "Login" box to location JP2 to choose 16pt mode. Ensure the Isolation jumpers J2,4,5, & 6 are in '8 Common' positions to correspond to the Siemens® counterpart 16 point modules (4 inputs/common). Also, note that many of the printed channels (CH1-CH 32) on the PC board are no longer valid, nor are the front panel connector labels. (You may find it helpful to utilize the appropriate 16 pt. connector labels shipped with the product.) If 16 Point is enabled, the following table's 16pt. row is the new correlation of PC board printing and front panel label's LED area printing. For example, in 16 Point Login Configuration, the board marking for channel 10 (CH 10) would be the input channel 6. Likewise, the PC board marking for CH 28 would correlate to input channel 16.

8 Point Mode:

Move jumper in "Login" box to location JP3 to choose 8pt mode. Ensure the Isolation jumpers J2,4,5, & 6 are in '8 Common' positions to correspond to the Siemens® counterpart 8 point modules (2 inputs/common). Also, note that many of the printed channels (CH1-CH 32) on the PC board are no longer valid, nor are the front panel connector labels. (You may find it helpful to utilize the appropriate 8 pt. connector labels shipped with the product.) If 8 Point is enabled, the following table's 8pt. row is the new correlation of PC board printing and front panel label's LED area printing. For example, in 8 Point Login Configuration, the board marking for channel 10 (CH 10) would be the input channel 4. Likewise, the PC board marking for CH 25 would correlate to input channel 7.

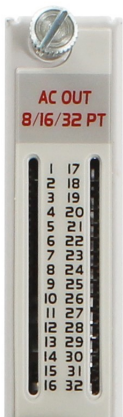

Note:

When the module is set to 8 or 16 point login the LED indicators do not correspond to the numbering on the front. In 8 point login outputs are 1- 2 at 1 and 2, 3 and 4 are displayed at 9 and 10, 5 and 6 are displayed at 17 and 18, 7 and 8 are displayed at 25 and 26. In 16 point login mode outputs are displayed at 1 thru 4 are displayed at 1 thru 4, and outputs 5 thru 8 are displayed at 9 thru 12, outputs 13 thru 16 are at 25 thru 28.

To correct the display labeling for different login modes CTI has labels available free of charge that can be placed over the front label for the LEDs numbering.

1	5	1	9
2	6	2	10
		3	11
		4	12
3	7	5	13
4	8	6	14
		7	15
		8	16

Figure 1. LED Number Labels

2599 8/16/32-Point AC Discrete Output Module

Mode	Channel/Fuse Labeling																															
CH#	1	2	3	4	5	6	7	8	9	10	11	12	13	14	15	16	17	18	19	20	21	22	23	24	25	26	27	28	29	30	31	32
32pt:	1	2	3	4	5	6	7	8	9	10	11	12	13	14	15	16	17	18	19	20	21	22	23	24	25	26	27	28	29	30	31	32
16 pt:	1	2	3	4	-	-	-	-	5	6	7	8	-	-	-	-	9	10	11	12	-	-	-	-	13	14	15	16	-	-	-	-
8 pt:	1	2	-	-	-	-	-	-	3	4	-	-	-	-	-	-	5	6	-	-	-	-	-	-	-	7	8	-	-	-	-	-

Figure 2. Channel/Fuse Labeling

Jumper Configuration	
Jumper	Selection
J2, J4, J5, J6	8 Common
JP 2, 3	JP 1 - 32 pt. Login

Figure 1. Standard Shipping Configuration

Note:
Do not alter jumper settings from '8 COMMON' when in 8 Point Login or 16 Point Login. The module is configured as needed for proper wiring with its Siemens® counterpart in this setting.

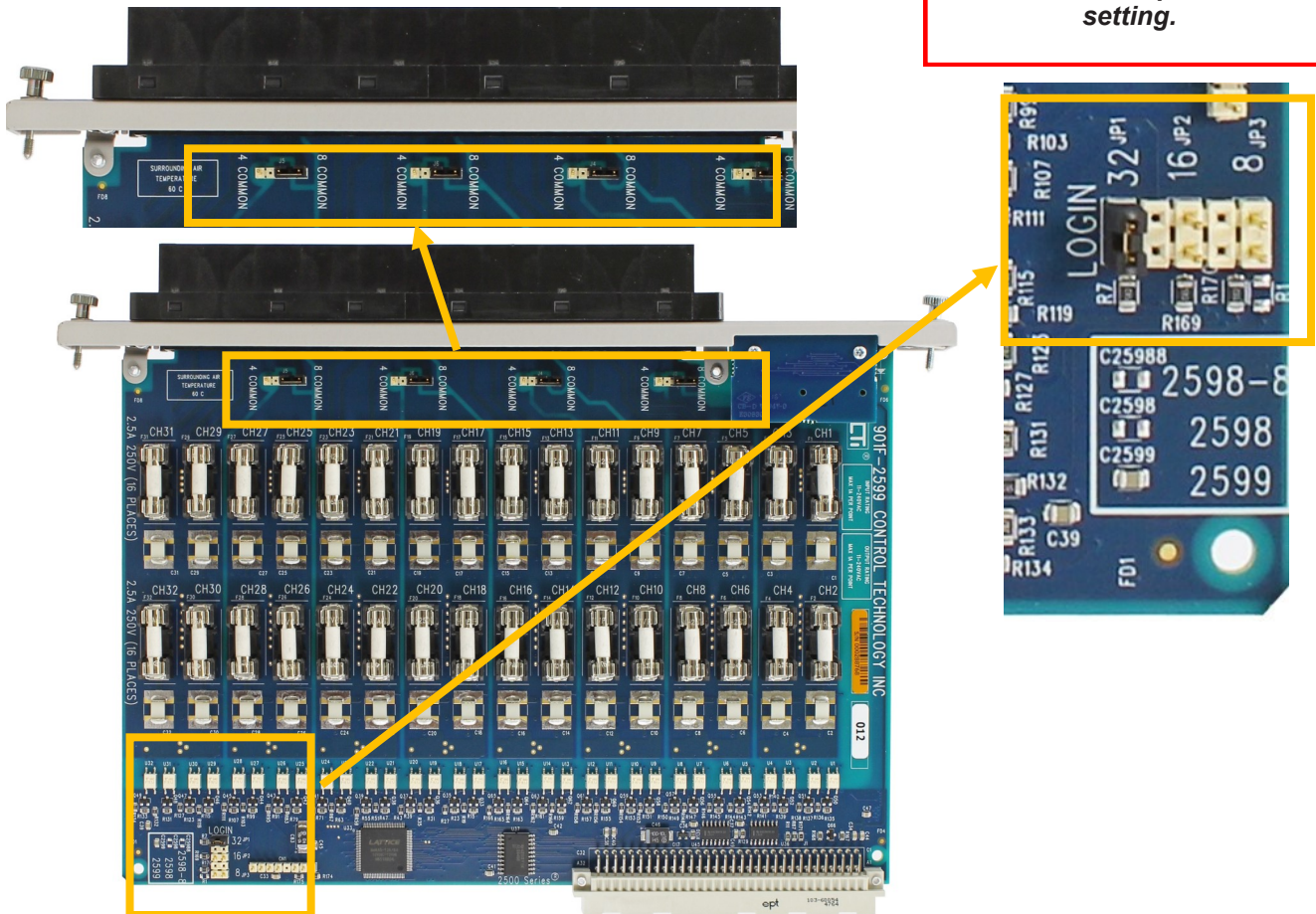

Figure 3. CHANNEL/FUSE LABELING, 8/4 COMMON JUMPERS and LOG-IN JUMPERS
(also see chart in Figure 2 for actual channel correlations)

2599 8/16/32-Point AC Discrete Output Module

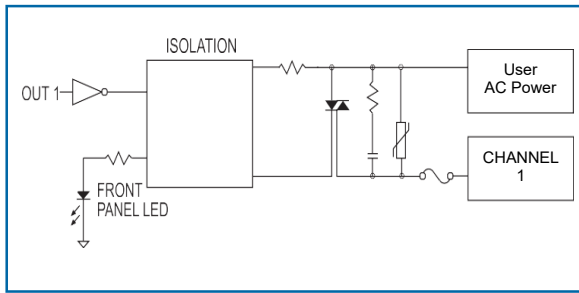

Figure 4. Typical Internal Circuit

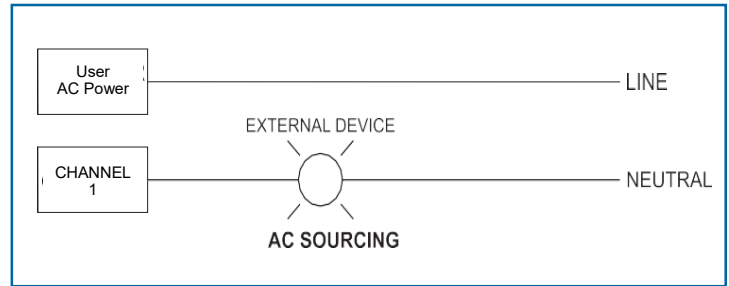
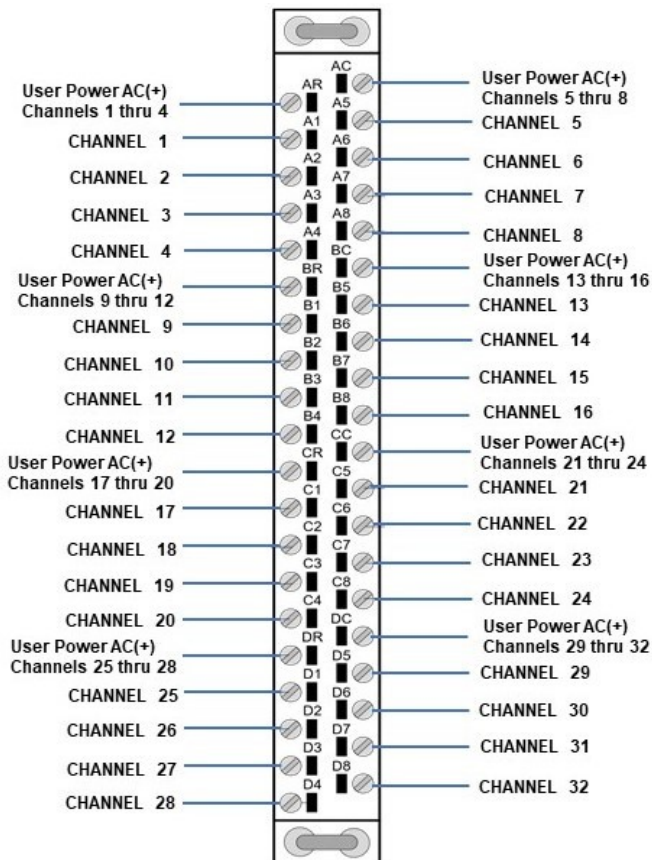
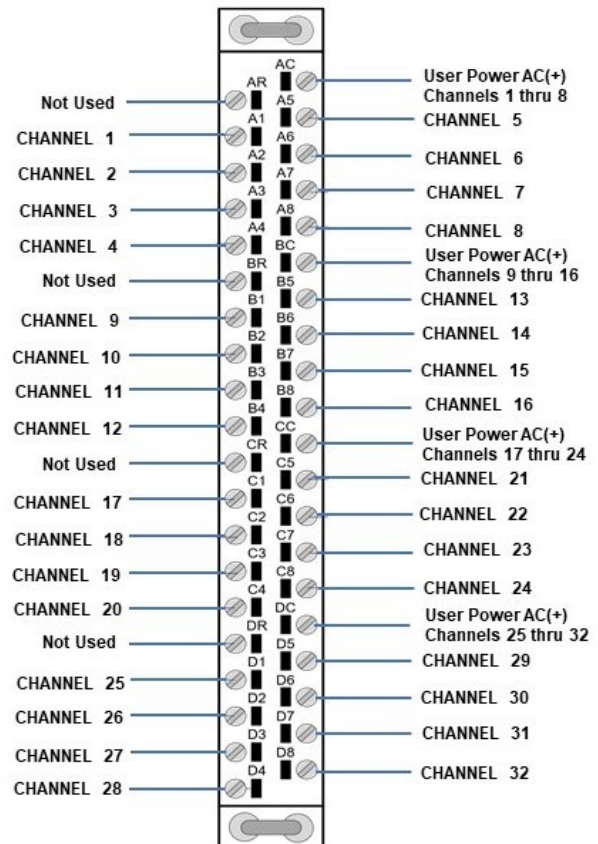

Figure 5. Typical External Wiring Diagram

Note: The 2599 uses the 2500-40F removable wiring connector. This connector is ordered separately.



**2599 Selector in 32 pt Login
4 Outputs per Common Wiring Connector**



**2599 Selector in 32 pt Login
8 Outputs per Common Wiring Connector**

2599 8/16/32-Point AC Discrete Output Module

Note: The 2599 uses the 2500-40F removable wiring connector. This connector is ordered separately.

Note:
Do not alter jumper settings from '8 COMMON' when in 8 Point Login or 16 Point Login. The module is configured as needed for proper wiring compatibility with its Siemens® counterpart in this setting.

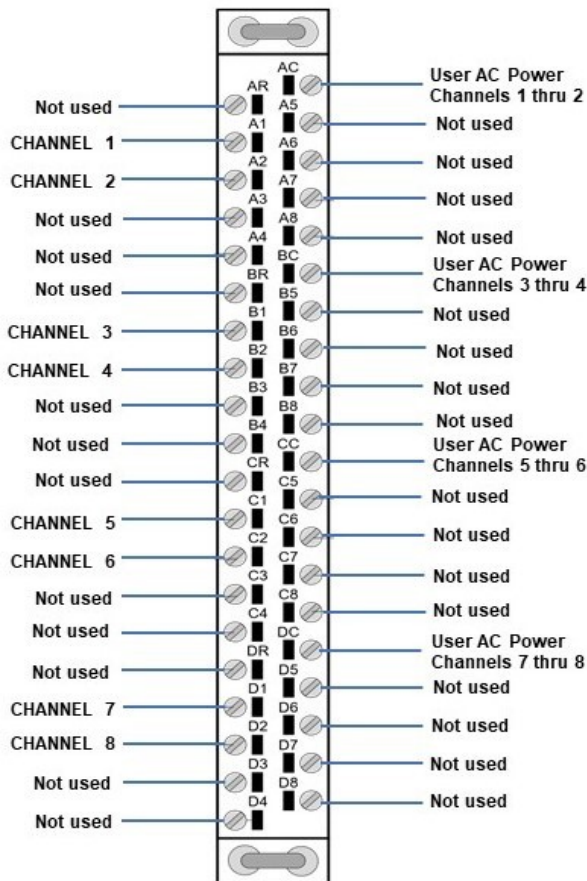

2599 Selector in 8 pt Login
2 Outputs per Common Wiring Connector

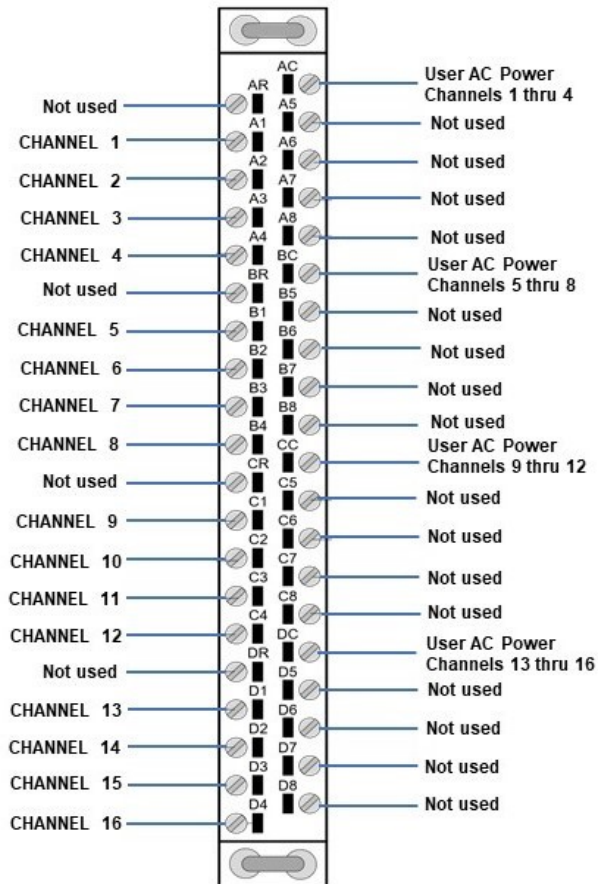

2599 Selector in 16 pt Login
4 Outputs per Common Wiring Connector

2599 8/16/32-Point AC Discrete Output Module



CAUTION – Non-Hazardous Areas/Hazardous Areas

WARNING – EXPLOSION HAZARD. DO NOT REMOVE OR REPLACE WHILE CIRCUIT IS LIVE UNLESS THE AREA IS FREE OF IGNITIBLE CONCENTRATIONS.	AVERTISSEMENT – RISQUE D'EXPLOSION. NE PAS RETIRER NI REMPLACER PENDANT QUE LE CIRCUIT EST SOUS TENSION À MOINS QUE L'EMPLACEMENT NE SOIT EXEMPT DE CONCENTRATIONS INFLAMMABLES.
WARNING – EXPLOSION HAZARD. DO NOT REMOVE OR REPLACE FUSE WHEN ENERGIZED.	AVERTISSEMENT – RISQUE D'EXPLOSION. NE PAS RETIRER NI REMPLACER UN FUSIBLE SI L'APPAREILLAGE EST SOUS TENSION.

Turn off power to the system before replacing fuses either in power supplies or IO modules. Refer to Product Bulletin or Installation and Operation Guide for specific information on the correct fuse for replacement. If there are any questions please contact CTI support. Fuses should only be replaced by qualified technicians.