

2554-A 4-Channel High-Speed Counter Input Module

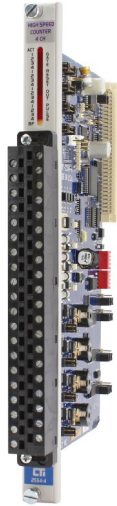

Specifications

Maximum Input Frequency: 65 KHz

Input Protection: 50 VRMS continuous
20,000 Volts ESD

Filtering Time Constant:

0.3 Sec (digital filtering enabled)

Update Time: 100 mSec for all four channels

Discrete Outputs: 4 (one per channel)

11 to 60 VDC, 1.5A, fused

⚠ Fuse: 3A, 250V (Littlefuse 2173.15 or Bussman GMA-3A)

Isolation: 1500 VDC channel-to-channel

1500 VDC channel-to-PLC

Connectors: Requires 2500-40F

Wire Gauge: 14-22AWG

Backplane Power: 2.5 Watts @ +5 VDC

Module Size: Single-wide

Shipping Weight: 1.5 lbs. (0.68 Kg)

Description

The 2554-A is a 4-channel isolated high-speed counter input module designed to be compatible with the CTI 2500 Series or Simatic® 505 I/O base. The 2554-A operates in three selectable modes: frequency, period, or general counter. In addition, two channels may be configured together for quadrature mode operation.

The 2554-A is extremely useful when there is a requirement to measure rapidly changing pulse inputs with a high degree of accuracy and convert them to counts, frequency, or period measurements. The module can also trigger external events based on preset counter values and auto-reset the count without missing an input pulse.

Additional Product Information:

On CTI's Website you find will links to the 2500 Series Std Environmental Specifications and the UL Agency Certificates of Compliance .

Application

The 2554-A is ideally suited for precise position measurement applications where an external edge reset is required. Other applications such as continuous flow monitoring and interface to encoders are targeted with the 2554-A.

ROCK SOLID PERFORMANCE. TIMELESS COMPATIBILITY.



Control Technology Inc.

5734 Middlebrook Pike, Knoxville, TN 37921-5962
Phone: +1.865.584.0440 Fax: +1.865.584.5720
www.controltechnology.com

2554-

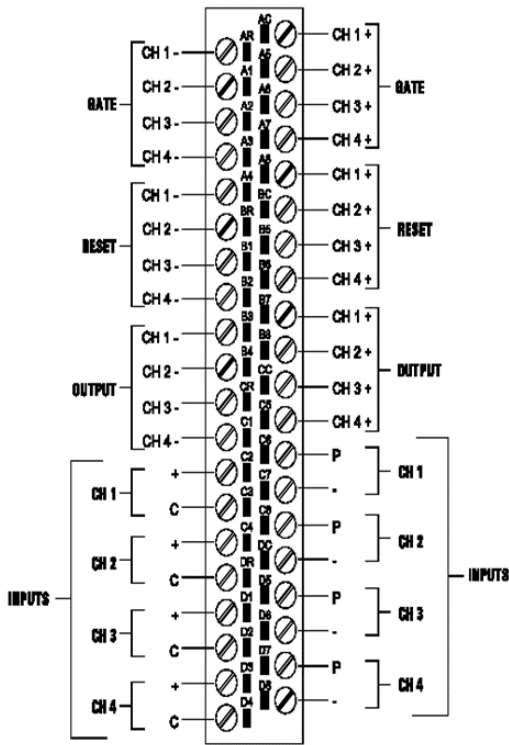

2554-A Connector Diagram

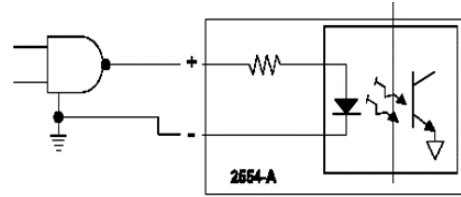

TTL Sourcing Application

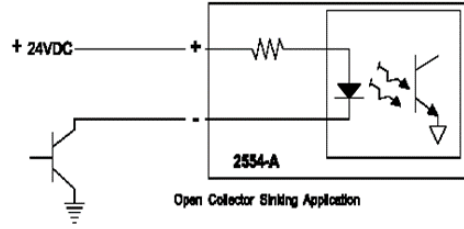

Open Collector Sinking Application

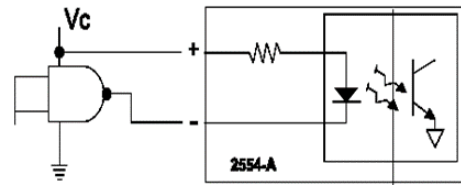

TTL Sinking Application

Gate and Reset Input Circuits

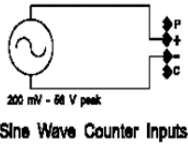

Sine Wave Counter Inputs

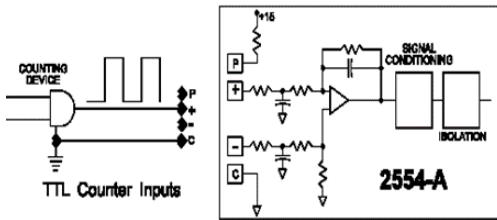

TTL Counter Inputs

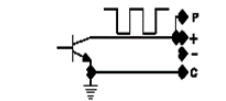

Open Collector Counter Inputs

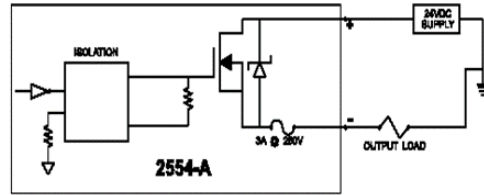

REPLACEMENT FUSE: LITTELFUSE 2173-15 OR BUSSMAN GMA-3A

Output Circuit

ROCK SOLID PERFORMANCE. TIMELESS COMPATIBILITY.

2554-A 4-Channel High-Speed Counter Input Module



CAUTION – Non-Hazardous Areas/Hazardous Areas

WARNING – EXPLOSION HAZARD. DO NOT REMOVE OR REPLACE WHILE CIRCUIT IS LIVE UNLESS THE AREA IS FREE OF IGNITIBLE CONCENTRATIONS.	AVERTISSEMENT – RISQUE D'EXPLOSION. NE PAS RETIRER NI REMPLACER PENDANT QUE LE CIRCUIT EST SOUS TENSION À MOINS QUE L'EMPLACEMENT NE SOIT EXEMPT DE CONCENTRATIONS INFLAMMABLES.
WARNING – EXPLOSION HAZARD. DO NOT REMOVE OR REPLACE FUSE WHEN ENERGIZED.	AVERTISSEMENT – RISQUE D'EXPLOSION. NE PAS RETIRER NI REMPLACER UN FUSIBLE SI L'APPAREILLAGE EST SOUS TENSION.

Turn off power to the system before replacing fuses either in power supplies or IO modules. Refer to Product Bulletin or Installation and Operation Guide for specific information on the correct fuse for replacement. If there are any questions please contact CTI support. Fuses should only be replaced by qualified technicians.

ROCK SOLID PERFORMANCE. TIMELESS COMPATIBILITY.