

USER GUIDE

PLC WorkShop for Modicon

Version 5.x

FasTrak
SoftWorks, Inc.

www.fast-soft.com

262.238.8088

Throughout this document, PLC WorkShop for Modicon – 32 Bit will be referred to as PLC WorkShop.

PLC WorkShop is a trademark of FasTrak SoftWorks, Inc.
Modicon is a trademark of Schneider Electric, Inc.
Windows is a registered trademark of Microsoft Corporation.

LICENSE TERMS AND CONDITIONS

FasTrak SoftWorks, Inc.

Licensor is the owner of all rights, including the copyright, in and to that certain set of executable computer programs identified in the Registration Form, including design and structure thereof (the "Software"), together with all manuals and other written or printed technical material provided with the Software to explain its operation and to aid in its use (the "Documentation"). Licensee wishes to have the right to use the Software, and Licensor is willing to grant such a right to Licensee on the terms and conditions set forth herein.

1. **GRANT OF LICENSE.** In consideration of Licensee's payment of the license fee referred to below and Licensee's agreement to abide by the terms and conditions stated herein, FasTrak SoftWorks, Inc. (referred to as "Licensor") grants Licensee a nonexclusive right to use and display one (1) copy of the Software with respect to one microcomputer at a time for so long as Licensee complies with the terms hereof. Licensor retains the right to terminate this Agreement and Licensee's rights at any time, by written notice to Licensee, in the event Licensee violates any of the provisions hereof.

Licensor reserves all rights in and to the Software and Documentation not expressly granted to Licensee herein. Licensee agrees to pay Licensor the license fee specified by Licensor as of the date hereof, payable in full upon deliver of a copy of the Software and Documentation to Licensee. Licensee acknowledges that the license fee payable hereunder is consideration solely for the right to use the Software, and payment thereof will not entitle Licensee to support, assistance, training, maintenance or other services, or the enhancements or modifications to the Software which may subsequently be developed by Licensor, except as otherwise expressly provided in this Agreement.

2. **LICENSEE'S AGREEMENTS.** Licensee agrees to comply with the terms and conditions set forth in this Agreement, specifically including but not limited to the following:

- (a) Licensee will take all reasonable steps to protect the Software from theft or use contrary to the terms of this Agreement.
- (b) Licensee agrees to pay Licensor additional license fees as specified by Licensor if and to the extent Licensee intends to use or does use the Software in any way beyond the scope of this Agreement.
- (c) Licensee agrees not to modify the Software and not to disassemble, decompile, or otherwise reverse engineer of the Software.
- (d) Licensee agrees to either destroy or return the original and all existing copies of the Software to Licensor within five (5) days after receiving notice of Licensor's termination of this Agreement.
- (e) Licensee agrees not to disclose the Software or Documentation or any part thereof or any information relating thereto to any other party, it being understood that the same contains and/or represents confidential information which is proprietary to Licensor.

3. **OWNERSHIP OF SOFTWARE.** Licensee shall be deemed to own only the magnetic or other physical media on which the copy of the Software provided to Licensee is originally or subsequently recorded or fixed, as well as any boards, key-locks, or cables provided for use with the Software, but an express condition of this Agreement is that Licensor shall at all times retain ownership of the Software recorded on the original diskette copy and all subsequent copies of the Software, regardless of the form or media in or on which the original or other copies may initially or subsequently exist. This Agreement does not constitute a sale of any copy of the Software to Licensee.

4. **POSSESSION AND COPYING.** Licensee agrees that the Software will only be displayed or read into or used on one (1) computer at a time, at the location designated for notices to Licensee under paragraph 13, below. Licensee may change the computer on which Licensee uses the Software to another computer at such location. Licensee agrees not to make copies of the Software other than for its own use, all of which copies shall be kept in the possession or direct control of Licensee. Licensee agrees to place a label on the outside of all copies showing the program name, version number, if applicable, and Licensor's copyright and trademark notices in the same form as they appear on the original licensed copy.

5. **TRANSFER OR REPRODUCTION.** Licensee is not licensed to copy, rent, lease, transfer, network, reproduce, display or otherwise distribute the Software except as specifically provided in this Agreement. Licensee understands that unauthorized reproduction of copies of the Software and/or unauthorized transfer of any copy of the Software is a violation of law and will subject Licensee to suit for damages, injunctive relief and attorney's fees. Licensee further understands that it is responsible for the acts of its agents and employees. Licensee may not transfer any copy of the Software to another person or entity, on either a permanent or temporary basis, unless Licensee obtains the prior written approval of Licensor which will ordinarily be subject to payment of Licensor's then current license transfer fee. Such approval will not unreasonably be withheld if Licensee advises Licensor in writing of the name and address of the proposed transferee, such transferee is suitable in Licensor's sole judgement, and such transferee agrees in writing to be bound by the terms and conditions of this Agreement. If the transfer is approved, Licensee must deliver all copies of the Software, including the original copy to the transferee.

6. **ENHANCEMENTS AND UPDATES.** Licensor may from time to time release updates of the Software incorporating changes intended to improve the operation and/or reliability of the Software. Such updates will be provided to Licensee at no charge (except shipping charges and media costs) for a period of twelve (12) months from the date hereof, and Licensee agrees to install all updates designated by Licensor as mandatory. Licensor may also offer enhanced versions of the Software from time to time incorporating changes intended to provide new or enhanced features and/or capabilities, at such license fees as Licensor may from time to time establish.

7. **LIMITED WARRANTY AND DISCLAIMER OF LIABILITY.** LICENSOR HAS NO CONTROL OVER THE CONDITIONS UNDER WHICH LICENSEE USES THE SOFTWARE. THEREFORE, LICENSOR CANNOT AND DOES NOT WARRANT THE PERFORMANCE OR RESULTS THAT MAY BE OBTAINED BY ITS USE. HOWEVER, LICENSOR PROVIDES THE FOLLOWING LIMITED WARRANTY:

Licensor warrants, for a period of twelve (12) months only, that the Software shall be free from significant programming errors. Licensor further warrants that it has full power and authority to grant the rights granted by this Agreement with respect to the Software and that the use by Licensee of the Software and Documentation will not infringe the rights of others. In the event Licensee believes that it has discovered one or more significant programming errors, Licensee shall immediately notify Licensor of such fact in writing. If such notice is received by Licensor within twelve (12) months from the date hereof, Licensor shall, within a reasonable time, subject to the demands of Licensor's other customers and subject to delays beyond Licensor's control (including but not limited to labor trouble, illness, delays in shipment of materials, and bad weather), at Licensor's expense, correct the programming errors. In the event Licensor is unable to correct the programming error within a reasonable time, Licensee may elect to terminate this Agreement and receive a refund of the licensee fee paid hereunder. For purposes hereof, a programming error is "significant" only if, as a result thereof, the software does not substantially perform the functions described in the Documentation. Licensor does not warrant that the operation of the Software will be uninterrupted or error free. EXCEPT FOR THE ABOVE EXPRESS WARRANTY, LICENSOR MAKES AND LICENSEE RECEIVES NO WARRANTIES, EXPRESS, IMPLIED, STATUTORY OR OTHERWISE, AND LICENSOR SPECIFICALLY DISCLAIMS ANY IMPLIED WARRANTY OF MERCHANTABILITY OR FITNESS FOR A PARTICULAR PURPOSE.

THE REMEDY PROVIDED HEREIN IS EXCLUSIVE. UNDER NO CIRCUMSTANCES WILL LICENSOR BE RESPONSIBLE FOR DIRECT, INDIRECT, INCIDENTAL, CONSEQUENTIAL OR OTHER DAMAGES OR LOST PROFITS. LICENSEE ACKNOWLEDGES THAT THE LICENSE FEE HEREUNDER IS NOT ADEQUATE FOR LICENSOR TO ASSUME OBLIGATIONS TO LICENSEE GREATER THAN THE EXPRESS REMEDY PROVIDED ABOVE.

8. **GOVERNING LAW.** The validity and performance of this Agreement shall be governed by Wisconsin law, except as to copyright and trademark matters which are governed by United States laws and international treaties. This Agreement is deemed entered into in Wisconsin. All lawsuits arising out of this Agreement shall be brought in a court of general jurisdiction in Milwaukee, Wisconsin. Licensor shall be entitled to recover its costs and expenses (including attorney's fees) incurred in enforcing its rights under this Agreement.

9. **WAIVER.** The failure of Licensor to enforce any of the provisions hereof shall not be construed to be a waiver of the right to enforce such provisions at a later time or to enforce any of the other provisions hereof.

10. **EFFECT OF TERMINATION.** The expiration or termination of this Agreement shall not affect the obligations of Licensee which by their character are of continuing nature.

11. **INTEGRATION.** This Agreement sets forth the entire understanding and agreement of the parties shall be bound by any conditions, definitions, warranties or representations with respect to any of the terms or conditions hereof other than as expressly provided in this Agreement. This Agreement may only be modified by a writing signed by the party to be charged.

12. **BINDING EFFECT.** This Agreement shall be binding upon and shall inure to the benefit of the parties hereto and their respective successors and assigns, subject to the limitations on the transfer of Licensee's rights to the Software provided in paragraph 5, above.

13. **NOTICES.** All notices shall be in writing and shall be hand delivered or sent by U.S. mail, first class, postage prepaid, if to Licensor at its address first above written, and to Licensee at the address indicated in the Registration Form. A party may change its address for notices at any time by notice to the other party in the manner provided herein, but each party may have only one address for notices at a time.

14. **REGISTRATION FORM.** The Registration Form is a part of this Agreement and is incorporated herein by reference. This Agreement will not take effect, and Licensee will have no rights whatsoever with respect of the Software, unless and until the Registration Form is duly executed and returned to the Licensor and is accepted by Licensor.

Table of Contents

1 - INTRODUCTION.....	1
Manual Design.....	1
Customer Support.....	1
What is PLC WorkShop?	2
Package Contents	2
Hardware Requirements	2
Software Requirements	3
Parallel Port Compatibility.....	3
2 - INSTALLATION.....	5
Installing PLC Workshop	5
Installing the FasTrak-KEY	5
Connecting the Communications Cable.....	7
3 - PLC WORKSHOP BASICS.....	11
Before You Begin.....	11
The Landscape: PLC WorkShop Window.....	12
Working with Logic Programs.....	17
Online Access Modes.....	28
Saving Logic Programs.....	30
Printing Logic Programs	34
Editing Features	42
Using WorkShop with FTVersionTrak	61
4 - PLC WORKSHOP SETUP	89
Overview	89
Program Setup	89
Application Setup.....	90
Communications Setup.....	91
Fast PLC Setup.....	97
File Associated Communications	97
Printer Setup	99
Page Setup	100
5 - FASTRAK AUTHENTICATION AND NT SECURITY	103
Overview.....	103
Choosing a Security Type	103

FasTrak Authentication Security.....	105
FasTrak Authentication Security Configuration Dialog	105
FasTrak Authentication Security Audit Setup	105
Password Security Setup	106
User Security Setup	111
NT Authentication Security.....	113
Overview	113
Installing the Security Server	113
Workgroups and Domains	115
Adding Users and Groups to the Operating System.....	115
Configuring DCOM for NT Authentication Security	118
Security Configurator	122
Security Audits.....	125
Event Viewer	126
6 - PLC CONFIGURATION	129
Overview	129
PLC Type Setup	129
PLC Configuration.....	130
Configuring the Modicon 984 Family Processors	133
PLC Status.....	165
7 - PROGRAMMING.....	197
Overview	197
Online versus Offline Programming.....	197
Using the Logic Editor.....	198
Using the ASCII Message Editor	210
Finding Logic.....	213
Trace Coil and Untrace Coil.....	216
Using the Data Window.....	219
Editing Logic	221
Disabling/Enabling Discrete I/O.....	226
DX Zoom.....	227
Using the Cross Reference Feature.....	233
Compare	234
Using the Diagnostic Features	236
Clearing Memory.....	240

8 - DOCUMENTATION	241
Using the Segment and Network Headers Editor.....	241
Using the Documentation Window.....	243
Documenting in Ladder.....	250
Edit Title Page (Print Only).....	252
9 - SYMBOLS	253
Overview.....	253
Using Symbols and Symbol Libraries in WorkShop.....	253
Programming with Symbols.....	255
Documenting with Symbols.....	256
The Symbols Library.....	258
10 - RELAYS, SHORTS, AND COILS	263
Relay Instructions.....	263
Vertical Branches and Horizontal Shorts.....	266
Coils.....	267
Duplicate Coils.....	270
NOBIT.....	271
NCBT.....	272
NBIT.....	272
SBIT.....	273
RBIT.....	274
11 - TIMERS AND COUNTERS	275
Timers.....	275
Up Counters.....	277
Down Counters.....	279
12 - ARITHMETIC INSTRUCTIONS	281
Arithmetic Functions.....	281
Addition Function.....	281
Subtraction Functions.....	284
Multiplication Function.....	287
Division Function (DIV).....	289
13 - TRANSFER AND MOVE INSTRUCTIONS	293
Data Transfer Functions.....	293
IBKR.....	304
IBKW.....	305

FIFO Move Operations.....	309
Logical Data Transfer Functions.....	312
14 - LOGIC BIT INSTRUCTIONS	323
Logical Compare (CMPR)	323
Logical Bit Modify (MBIT).....	326
Logical Bit Sense (SENS).....	328
Logical Bit Rotate (BROT).....	330
15 - STATUS INSTRUCTIONS	333
Monitoring System Status.....	333
16 - SPECIAL INSTRUCTIONS	379
DISA (Disabled Monitor System)	379
HIST (Discrete Logic Analyzer/Histogram).....	380
SKIP	381
READ (ASCII Read Function).....	383
WRIT (ASCII Write Function).....	385
XMRD (Extended Memory Read)	388
XMWT (Write Extended Memory).....	389
XMIT (Transmit)	392
17 - SOFTWARE LOADABLE MODULES	403
General Description	403
CALL	404
EARS.....	406
EUCA	407
FN10	408
HLTH (984 Health Status)	410
HSBY	411
MAP3	412
MBUS.....	413
MRTM (Multi-Register Transfer Module)	414
PEER	415
PID	416
18 - ENHANCED EXECUTIVE CARTRIDGE INSTRUCTIONS	417
BLKT (Block-to-Table Move).....	418
CKSM (CHECKSUM).....	419
EMTH (Extended Math)	422

MSTR.....	425
PID2.....	427
TBLK (Table-to-Block Move).....	428
19 - SUBROUTINES.....	431
JSR (Jump To Subroutine).....	431
LAB (Label Subroutine).....	433
RET (Return From Subroutine).....	434
20 - MISCELLANEOUS INSTRUCTIONS	435
Instructions for the 351/455 Processors	435
16-Bit Signed and Unsigned Math Functions.....	443
PCFL.....	451
DIOH	455
Instructions for the Micro PLCs	456
21 - FTLOGGER/FTTREND	485
FTLogger Overview	485
FTTrend Overview	485
22 - AUDITING	487
Activity Audit.....	487
INDEX	489

1 - Introduction

Manual Design

Welcome to PLC WorkShop, a powerful Windows-based tool in programming programmable logic controllers (PLCs). Whether you are a novice or an experienced programmer, this manual has been constructed to help you begin using PLC WorkShop quickly. We at FasTrak SoftWorks, Inc. have tried to assume little about you, the user, except that when you have a question regarding this software you'll want it answered. We hope this manual and the on-line help will answer those questions.

Chapter topics use names that will point you quickly to the specific information you want to find. Chapters are titled as follows:

Chapter Name	Description
1 - Introduction	Outlines manual contents, Customer Support numbers, and necessary hardware and software to run PLC WorkShop.
2 - Installation	Guides you through the installation procedures for the software and security.
3 - PLC WorkShop Basics	Describes PLC WorkShop features and helps you move through the Windows environment.
4 - PLC WorkShop Setup	Provides specific guidelines in setting up and customizing the software.
5 - FasTrak Authentication and NT Security	Provides instructions for establishing and using a Password Security Mode.
6 - PLC Configuration and Setup	Provides directions for configuring your processor to work with PLC WorkShop.
7 - Programming	Gives you solid understanding of PLC WorkShop's easy to use programming features.
8 - Documentation	Shows you how to add symbols, labels and comments to your logic programs.
9 - Symbols	Instructions for initializing and using graphical symbols for programming and documentation.
10-20 - Instructions	Gives detailed information about the PLC instructions including programming examples.
21 - FTTLogger/FTTrend	Shows you how to program the data Logger and Trender.
22 - Auditing	Outlines options for tracking program and setting changes.

Customer Support

It's our goal that customers become proficient users of our software as quickly and easily as possible. With that in mind, FasTrak makes available a number of support options. Commonly asked questions can usually be answered with this manual, online help, or by visiting our website at www.fast-soft.com. Our website features easy-to-access FAQs, technical resources, and system documentation.

For real-time how-to help and advanced troubleshooting, contact FasTrak's customer support center and speak directly with a technical support representative. Our trained experts offer convenient, accurate and prompt assistance.

Customer Support 262.238.8088
Customer Support Fax 262.238.8080
Email support@fast-soft.com
Website www.fast-soft.com

You may also forward questions, comments, and suggestions to:

FasTrak SoftWorks, Inc.
P.O. Box 240065
Milwaukee, WI 53224

What is PLC WorkShop?

PLC WorkShop is one of the world's most powerful and exciting programmable logic controller (PLC) programming software. PLC WorkShop is the universal solution offering features that will save you time and money, such as:

Symbolic Programming
Cut, Copy & Paste
Instruction Toolbar and Mnemonics
Multiple windows view and edit
Flexible program setup
Write, read, and force addresses from the Data Window
Multiple documentation options
Generous Online Help

Package Contents

Your PLC WorkShop package includes the items listed below. If any of these items are missing or damaged, please contact FasTrak SoftWorks Customer Service.

One (1) PLC WorkShop CD
PLC WorkShop User's Guide (this manual)
FasTrak-KEY to attach to your computer's parallel or USB port if applicable

Hardware Requirements

To install PLC WorkShop on your computer you need the following hardware.

A personal computer with an Intel Pentium 100 processor or higher
32 MB or more of RAM
An 800 X 600 VGA monitor with at least 256 colors
100 MB free disk space on your hard drive
A mouse is recommended, but not required

PLC WorkShop may not function properly on systems that are not 100% Intel compatible. Certain other hardware components and peripherals can create incompatibility problems.

Software Requirements

You also need the following software loaded on your computer before you install PLC WorkShop.
Windows 95, 98, NT, 2000, XP, or Vista

Parallel Port Compatibility

Connecting the FasTrak-KEY to your computer's parallel or USB port is required to use PLC WorkShop. Procedures for installing the FasTrak-KEY and PLC WorkShop are outlined in the next chapter. If your parallel port is not 100% IBM compatible, you may experience problems with the FasTrak-KEY, which will prevent PLC WorkShop from functioning properly.

In most cases, you can correct the parallel interface incompatibilities by replacing the parallel port with a 100% IBM compatible port or by adding a second printer adapter card.

NOTE: FasTrak SoftWorks is not responsible for problems that result from using an incompatible parallel interface.

2 - Installation

Installing PLC Workshop

Before you begin installation, review the System Requirements section in the Introduction chapter.

To install PLC Workshop, turn on the computer on and start Windows. A user name and password may be required to log in to a computer network. If unsure, contact your company's System Administrator or IT representative. Follow these steps to install the software:

1. Insert the PLC Workshop CD in your computer's CD-ROM drive.
2. The CD should start automatically. If not, click the Windows **Start** button. Then click **Run**, and type `x:\setup.exe`, where x is the letter for the CD-ROM drive.
3. Follow the instructions that appear on the screen.
4. After making your selection, click **Next**. Installation begins. A message will appear telling you that the PLC Workshop Installation Utility is loading.

Installing the FasTrak-KEY

What is the FasTrak-KEY?

The WorkShop software is copy-protected with a device called the FasTrak-KEY, which is included in your shipment. The FasTrak-KEY will be used for one of two purposes, depending on your licensing agreement with FasTrak SoftWorks, Inc:

- **Single-user keyed license** - Under this agreement, each FasTrak-KEY represents one single-user license. The FasTrak-KEY must be attached to your computer before you launch WorkShop. Otherwise, if a FasTrak-KEY is not detected, WorkShop will run in Demo mode with limited functionality.
- **Multi-user key on install only site license** - Under this agreement, one FasTrak-KEY is issued for your company. This key allows a certain number of installations of WorkShop based on your site license agreement. The FasTrak-KEY must be attached to your computer before you can install WorkShop, but can be removed once WorkShop is installed.

To attach the FasTrak-KEY to your computer, connect the key to a parallel port (LPT1-LPT3) or USB port on your computer, following the steps below. The FasTrak-KEY will not interfere with normal port data transmissions, nor will it prevent you from creating backup copies of the software.

NOTE: Installation of the FasTrak-KEY must be completed before you run PLC WorkShop. If a FasTrak-KEY is not detected, PLC WorkShop will run in Demo mode with limited functionality.

Connecting the FasTrak-KEY

Follow the steps below to install the FasTrak-KEY.

1. Determine which parallel or USB port to connect the FasTrak-KEY to.
2. Disconnect other security devices or cables attached to that port.
3. Connect the FasTrak-KEY to the port.
4. Attached other cables to the FasTrak-KEY, if necessary. If the device attached to the FasTrak-KEY is a parallel printer, make sure the printer is turned on before starting PLC WorkShop.

NOTE: The FasTrak-KEY must be the first device attached to the parallel port. Other devices or cables can subsequently be attached to the FasTrak-KEY.

Troubleshooting the FasTrak-KEY

Following is an error message associated with the FasTrak-KEY, possible causes, and solutions.

Message



Possible Causes

PLC WorkShop was started without the FasTrak-KEY attached to the parallel port.

A parallel port driver may be missing.

If running Windows NT, the NT driver may not be loaded.

Solution

Check to see that:

The FasTrak-KEY is connected to a parallel or USB port.

The FasTrak-KEY is the first device attached to the computer.

Any parallel printers attached to a parallel port are turned on.

If the above has been confirmed, the FT-Key Driver may need to be reinstalled. Visit our website at www.fast-soft.com to download a new FT-Key Driver.

Connecting the Communications Cable

The communications cable connects a serial port of the computer to the PLC. This enables programs and data to be transferred between the computer and the PLC. This cable has a 25-pin connector on the computer end and either a 9- or 25-pin connector on the PLC end.

The pin-outs for six possible communications cables are shown below.

9-Pin PLC Port to 25-Pin Serial Port

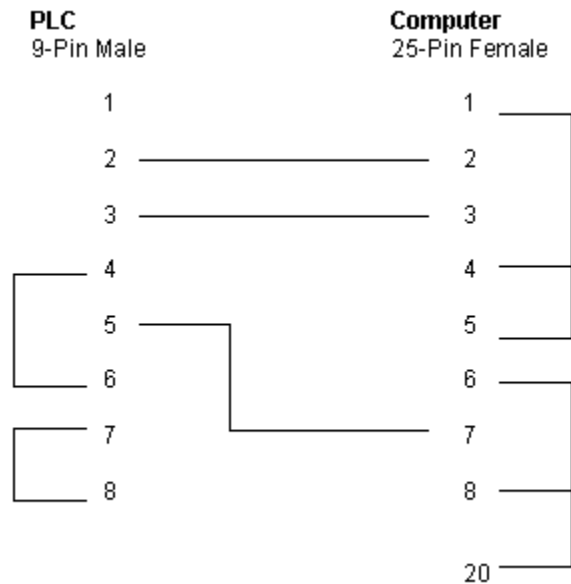

9-Pin PLC Port to 9-Pin Serial Port

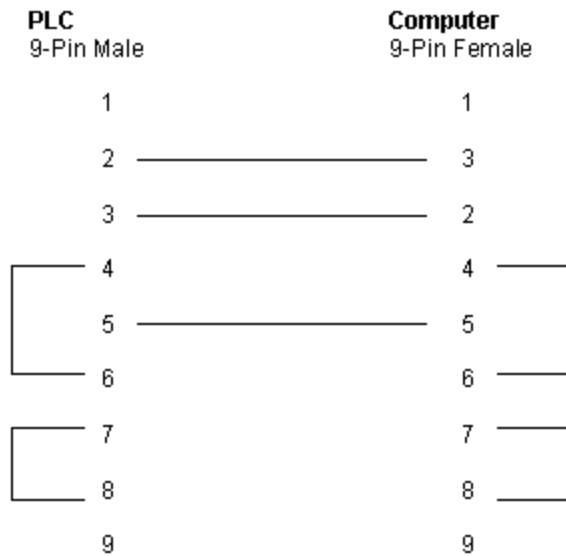

25-Pin PLC Port to 25-Pin Serial Port

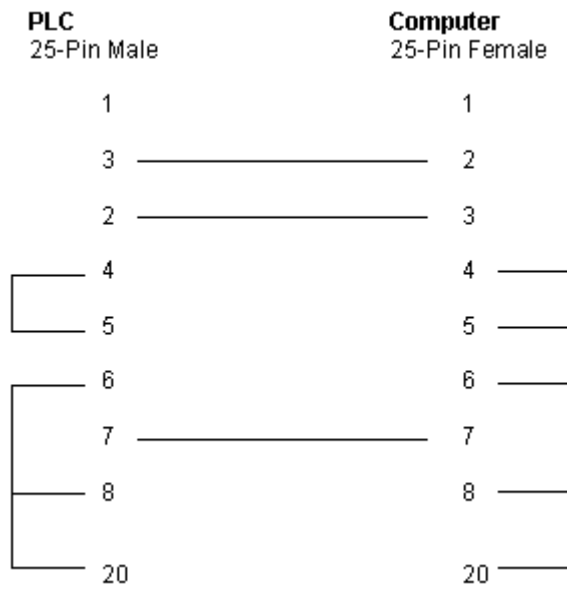

25-Pin PLC Port to 9-Pin Serial Port

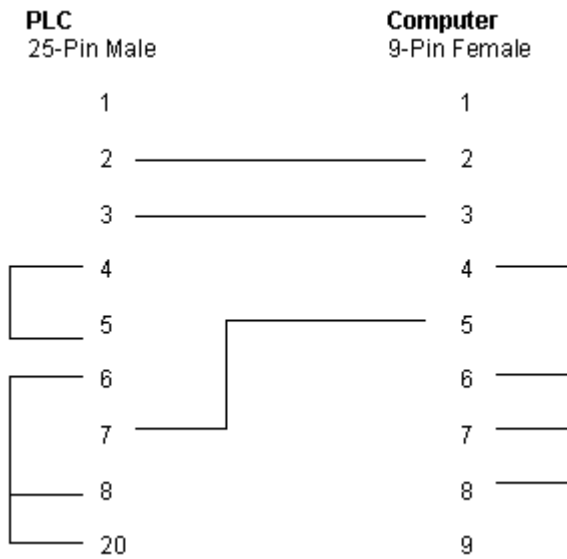

RJ45 PLC Port to 9-Pin Serial Port

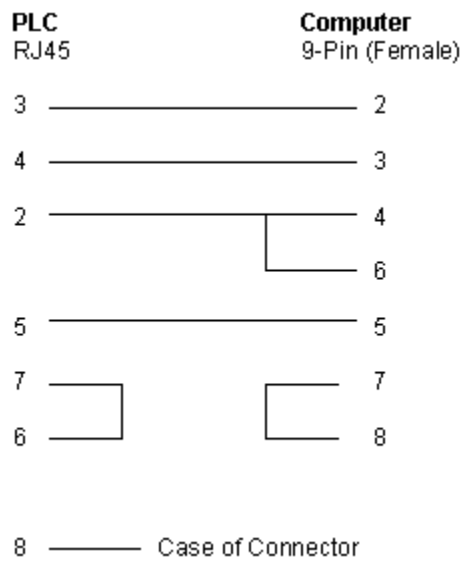

24-Pin PLC Port to 25-Pin Serial Port

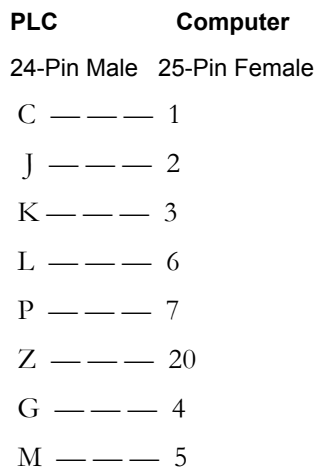

3 - PLC WorkShop Basics

Before You Begin

This chapter will get you started using PLC WorkShop by pointing out software features and outlining an approach to programming. The basics are covered as well, such as:

- Navigating the PLC WorkShop Window Landscape
- Working with Logic Programs
- Understanding Online Access Modes
- Saving Logic Programs
- Printing Logic Programs
- Editing Logic Programs
- Merging Logic Programs
- Importing/Exporting Logic Programs

Starting PLC WorkShop

After installing PLC WorkShop, launch PLC WorkShop by doing one of the following actions:

Double-click on the PLC WorkShop icon

From the **Start** menu, select **Programs/FasTrak SoftWorks/PLC WorkShop - 32 For Modicon**.

While PLC WorkShop loads the PLC WorkShop copyright screen will display. If PLC WorkShop does not detect a FasTrak-KEY, the following message appears.

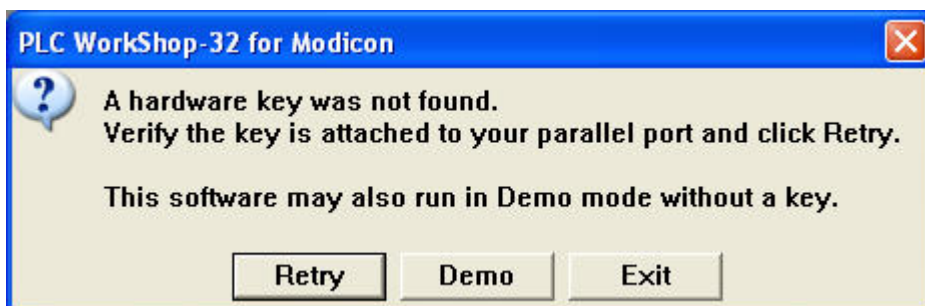

If this occurs, check to see that the FasTrak-KEY is:

Connected to a parallel or USB port

If connected to a parallel port, connected before printers or other devices

See *Connecting the FasTrak-KEY* in Chapter 2 - Installation.

After checking the key's installation, try to load PLC WorkShop from the icon. If PLC WorkShop continues to not detect the FasTrak-KEY, please call FasTrak's Customer Support at 262.238.8088 immediately.

When PLC WorkShop has loaded completely, the PLC WorkShop Window, as described and defined in the next section, will display.

The Landscape: PLC WorkShop Window

The PLC WorkShop window is the starting point for all work. The key features of the window are designated with arrows on the sample illustrated below. Definitions of each feature are next, followed by more detailed information.

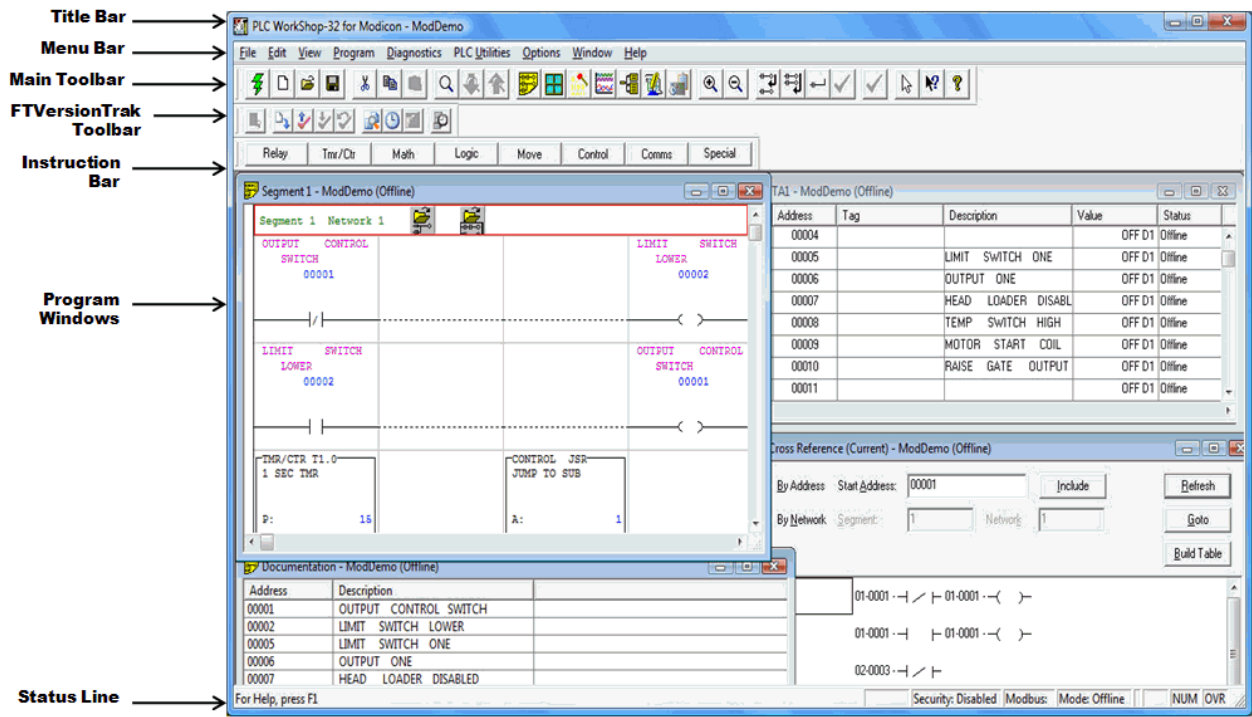

Window Description

The key features of the PLC WorkShop window are defined below. More detailed descriptions follow.

Window Feature	Function
Title Bar	Displays the name of the application. Buttons in the upper right corners change the window's size and position.
Main Toolbar	Use to quickly access frequently used menu options.
Menu Bar	Use to select PLC WorkShop functions
FTVersionTrak Toolbar	Use to perform version control operations using FTVersionTrak.
Instruction Bar	Use to add instructions, new rows and new networks to a logic program.
Status Line	Displays information about the operation in progress.
Program Windows	Demonstrates that you can display and edit multiple logic programs at the same time, limited only by the size of your computer's memory.





Title Bar

The Title Bar spans the top of the PLC WorkShop window.



Use the Title Bar for three purposes:

- To identify the application being used. In the example above, it's PLC WorkShop.
- To move the window. A window or dialog box can be moved by clicking on the title bar with the mouse pointer, holding down the left mouse button and dragging to the desired location.
- To change the size or position of the window. The following buttons appear on the right side of the title bar:

Button Title	Location	Function
Minimize 	Left box	Click the dash button to reduce window to an icon.
Maximize/Restore Down  	Middle box	Click the window button to enlarge the window when minimized, or shrink the window when maximized.
Close 	Right box	Click to exit WorkShop.

Menu Bar

The menu bar, located just below the title bar, identifies the names of the available PLC WorkShop functions. To display the menu options for each function, click on the function name. The menu options displayed may change depending upon the operation in progress.

For example, the Menu Bar illustrated below appears when you open PLC WorkShop.

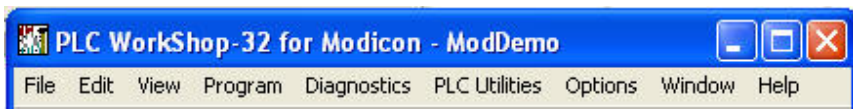





















Main Toolbar



The Main Toolbar, just below the Menu Bar on the PLC WorkShop window, displays a row of buttons. Each button represents an option you're likely to use frequently. Select the option by clicking on its button, saving you the steps of selecting several options from a series of menus. Notice that when you click on the button, its purpose appears on the Status Line at the bottom of the window.

The Menu Bar can be turned off and on by:

1. Selecting **Toolbars** from the **View** menu.

2. Then select or deselect the **Main Toolbar**.

Click	To
	Fast PLC Connection. See <i>Connecting to a PLC</i>
	Create a new program. See <i>Creating New Logic Programs</i>
	Open an existing program. See <i>Opening Logic Programs</i>
	Save the active program. See <i>Saving Logic Programs</i>
	Cut the highlighted section to the clipboard. See <i>Editing Logic Programs</i>
	Copy the highlighted section to the clipboard. See <i>Editing Logic Programs</i>
	Paste a section from the clipboard. See <i>Editing Logic Programs</i>
	Find a network, address, or symbol. See <i>Finding Logic</i>
	Find the next occurrence of the found address, or symbol. See <i>Finding Logic</i>
	Find the previous occurrence of the found address, or symbol. See <i>Finding Logic</i>
	Display the Logic Editor Window.
	Display the Data Window.
	Display the Cross Reference.
	Display the Documentation Window.
	Add a new row to a program.
	Enter and validate the active program.
	Launch FTLogger. See <i>FTLogger Overview</i>
	Launch FTTrend. See <i>FTTrend Overview</i>
	Insert New Network.
	Append New Network.
	Zoom in Logic.

	Zoom out Logic.
	Puts the PLC in to Run Mode.
	Stops the PLC (takes the PLC out of run mode).

Instruction Bar

The instruction bar defaults to appear at the top of PLC WorkShop window, just below the menu bar. The instruction bar and menu bar are both dockable.

Instructions are divided into groups. The groups appear on the top level the instructions for that group are on the lower level. To display the instructions for a group, press the group button. For example, to display the math instructions, press the Math group button. The Math group button remains selected until another group button is pressed.

The Instruction Bar can be turned off and on by:

1. Selecting **Toolbars** from the **View** menu.
2. Then select or deselect the **Instruction Bar** you wish to see.

To Insert an Instruction Bar Item in a Program

1. Click the desired instruction group button on the upper half of the Instruction Bar. Instructions for that group will appear on the lower half of the bar.
2. Click the button showing the item you want to insert in the program. The item attaches to the pointer when you move to the ladder editing area.
3. Move the pointer to the item insertion point on the ladder editing area and click the left mouse button. The instruction is dropped into place.
4. Repeat step 3 each time you want to add the same item.
5. Click on the arrow button in the middle of the Instruction Bar to return the pointer to an arrow.

Multiple Program Windows

PLC WorkShop gives you the ability to display more than one logic program window at a time. You can open as many logic program windows as your computer's memory permits.

For example, you may wish to copy part of a logic program to another program. This will save you programming time by not having to retype similar logic statements for each program. To copy a part of one logic program to another, use the following procedure:

1. Open both programs.
2. Arrange the logic program windows by selecting **Tile** or **Cascade** from the **Window** menu.
3. Highlight the data you want to copy to the other program by 'clicking the mouse and dragging across the data.
4. Click **Copy** from the toolbar or from the **Edit** menu.
5. Move the pointer to the place you want to insert the data in the other program. Click **Paste** from the toolbar or from the **Edit** menu.

Customizing Window Size and Position

By default, as WorkShop Logic, Documentation, Data, and Cross Reference (client) Windows are opened, each Window slightly overlaps the previously opened Window (cascades). Once opened, these Windows may be resized and moved as desired.

When individual client Windows are closed, or when WorkShop is terminated, the position and size settings of these Windows are saved and restored when the Windows are subsequently reopened.

If the WorkShop Window is resized or monitor resolution changed, the positions of the client Windows relative to WorkShop's client area are adjusted, maintaining the proportions of the client Windows to the client area.

NOTE: Window position and size restoration occurs at the application level and not the program level. For example, the Documentation Window of Program A is restored to the same position as the Documentation Window of Program B even when both programs are open at the same time.

Exceptions:

If multiple client Windows of the same type are open for the same program, only the first Window of a given type is restored. Any additional Windows of the same type will cascade upon opening.

If multiple client Windows of the same type are open when WorkShop terminates, position and size settings are not restored.

Windows are always restored to their normal state. Minimized and maximized states are not retained when Windows are closed.

Floating Documentation Window

The Floating Documentation Window shows documentation for the address on which the parameter cursor is located. As the cursor moves, the information in the window changes.

The window can be configured to show either the description only, or the tag, description, and comment. To configure the window, or to turn it on or off (it is off by default) use the **Application Setup** dialog.

The window may be docked to a side of the PLC WorkShop window.

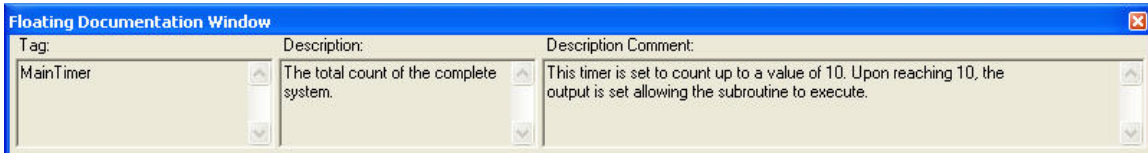

Status Line

The Status Line spans the bottom of the PLC WorkShop window. It displays information or describes the current operation on the left side. To display status line information for a menu item or button, click on the item or button and hold the left mouse button.

The right side of the Status Line displays the information listed below.

PLC Route	The first shadowed box on the status line displays the route
------------------	--

	defined for the active program. If the PLC route is a direct serial connection to a PLC, then Direct is displayed. The on-line PLC route is taken directly from the controller you are connected to. The off-line PLC route informs you as to the parameter saved in the PLC setup window for this particular program.
Logic Mode	Indicates whether you are programming on-line or off-line.
Cursor Type	Indicates cursor type, either insert (Ins) or overwrite (Ovr). With characters to the right of the cursor, in insert mode characters are moved one space with each character typed. In overwrite mode characters to right of the cursor are replaced with each new character typed.
NUM	Indicates if Num Lock is active for the keyboard. Thus numbers will be typed when using the keypad, which is usually on the right side of the keyboard. Num Lock is not active when indicator area is blank.
CAP	Indicates if Caps Lock is active for the keyboard. When typing, capital letters will appear if Caps is indicated. Caps Lock is not active when indicator area is blank.
Valid Ranges	Indicates legal address range for the instruction at the current position.

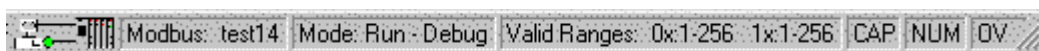

Working with Logic Programs

Creating a New Logic Program

With PLC WorkShop, it's easy to create a new program.

NOTE: New programs may be created in offline mode only. To connect to a processor online, use the **File/Open** or **File/Fast PLC Connect** menu items.

To create a new logic program and begin programming, do the following:

1. Select the **File/New** menu item, click the  toolbar icon, or press [Ctrl+N] on the keyboard.
2. Select the PLC Type.
3. Press **OK**.

Fast PLC Connection - Connecting to a PLC

With PLC WorkShop, the PLC can be connected to with a click of the mouse and existing logic in the PLC can then be viewed and edited.

Prior to connecting the first time, the PLC connection must be set up. Refer to Chapter 4 - Fast PLC Setup for more details.

To connect to a PLC online, select the **File/Fast PLC Connection** menu item or click the  toolbar icon.

NOTE: Files cannot be loaded with Fast PLC Connection. To load a file Online, use the **Open Program** dialog, which is accessed through the **File/Open** menu item.

Preventing Fast PLC Connection

To prevent connection by Fast PLC:

1. Select the **Options/Application Setup** menu item. The **Application Setup** dialog appears.

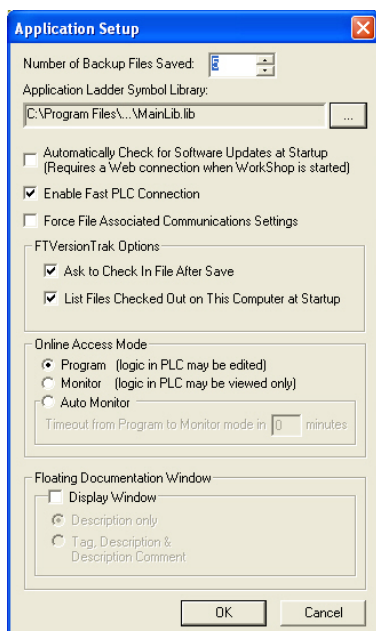

2. Deselect the **Enable Fast PLC Connection** check box.

Opening an Existing Logic Program Offline or Online

You can open an existing logic file to edit or update program information in either online or offline mode. Logic programs may contain one or more of the following: logic and data, tags, headers, and descriptions and comments. Several programs may be open at one time without losing memory contents.



Warning

Editing or modifying a program online may produce unexpected or hazardous results.

To open an existing program:

1. Select the **File/Open** menu item, click the  toolbar icon, or press [Ctrl-O]. The **Open Program** dialog appears.

NOTE: The last four files that were opened are saved and listed at the bottom of the **File** menu. When one of these files is selected, the **Open Program** dialog automatically opens with the file that has been selected.

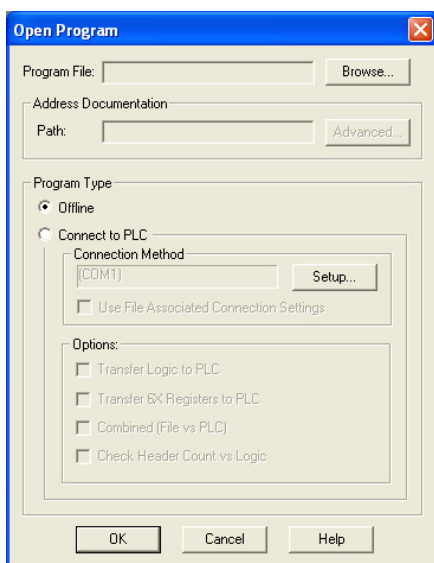

2. Click **Browse**. The **Open** dialog appears.
3. Change drives and/or directories, if necessary, to find the program you wish to open. You can open *.FMD (PLC WorkShop 32-bit files), *.FTK (PLC WorkShop 16-bit files), *.PGR (PLC WorkShop DOS files) or *.CFG (ModSoft configuration) files.
4. Click on the program name in the **File Name** scroll box and click **OK**. The name of the program appears in the **Program File** and **Address Documentation** fields of the **Open Program** dialog. If a different documentation program is desired, it may be linked via the **Share Address Documentation** function.
5. In the **Program Type** group box, select **Offline** or **Connect to PLC**. If **Connect to PLC** is selected, the previously saved communication port can be used or a new communication port selected by clicking the **Setup** button and other options may be chosen, such as **Transfer Logic to PLC** - Transfers all logic and data areas to the PLC, and loads documentation.
6. Click **OK** or press [Enter] to open the program.

Sharing Address Documentation

When a file is configured, a database file that holds and sorts all documentation can be specified. Multiple users can simultaneously modify documentation for the same file, thus regular updates can be scheduled to get the latest documentation within the database. Documentation can be imported from *.FMD (PLC WorkShop 32-bit files), comma or tab separated. Conversely documentation can be exported from the database file into a text file or *.PGR (PLC WorkShop DOS files).

To set up shared documentation:

1. Access the **Open Program** dialog by selecting the **File/Open** menu item.
2. Click **Browse** to select a file.
3. Click the **Advanced** button of the **Open Program** dialog. The **Share Address Documentation** dialog appears.

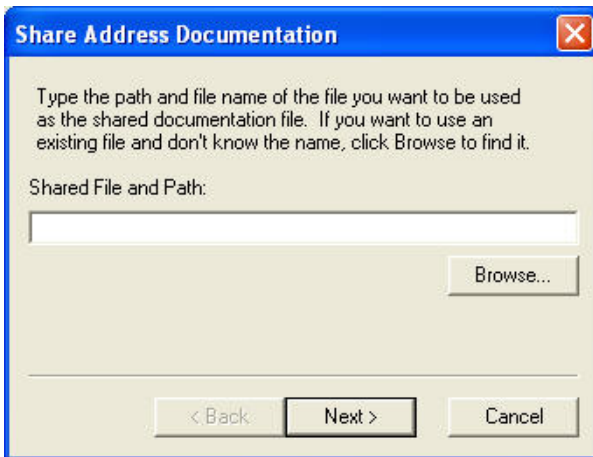

4. Enter the share address documentation program name and path in the **Shared File and Path** field to create a new file or select **Browse** to locate an existing file. If creating a new file, when prompted, click **Yes** to confirm that it should be created.
5. Click **Next**. The following screen appears.

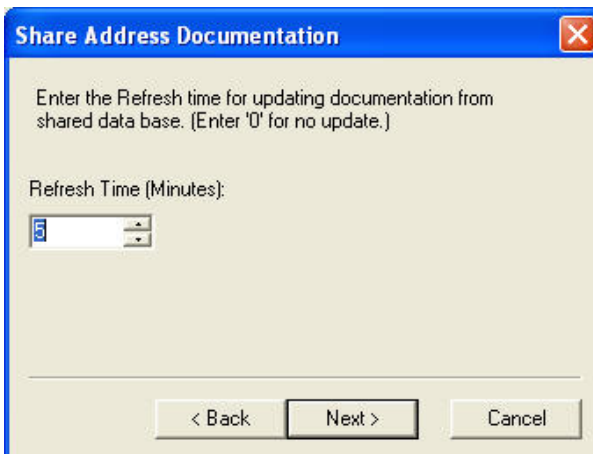

6. Enter the refresh rate (time lag between updates from other users of the database). Valid times are from 1 to 1440 minutes.
7. Click **Next**. The following screen appears.

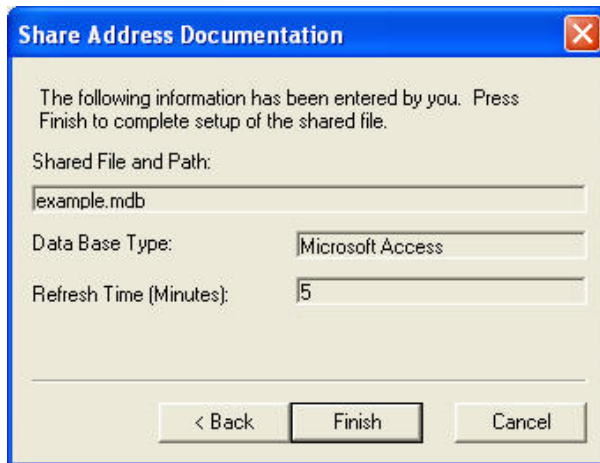

8. Click **Finish**. The **Open Program** dialog reappears with the new filename and path for the address documentation.

Combined

If you have an existing file and want to connect online, to a controller that the program resides in, you can use the **Combined** feature to go online faster. Combined also allows for any online edits of Ladder, TCOP, ASCII message, Configuration Extension, Modbus Ports, ASCII Ports and Segment Scheduler to be made to the PLC and Databases at the same time which allows for a faster online save. You select **Combined Mode** in the **Open** dialog by selecting the Combined checkbox.

For Combined Mode to work, the file that is used to attach online is assumed to be an exact match with the PLC program.

If the ladder or basic configuration does not match, connection online is not allowed.

Even if ladder, Coils Used (including Battery coil), configuration, Modbus Ports, State Table (Registers) match after attach, the following parts could still be different:

Configuration:

- DAT Loadables
- TCOP
- Configuration Extension
- Solve Table
- ASCII Port Parameters
- EXE Loadables

ASCII:

- ASCII Message

Data:

- Never checked

Combined Mode does not allow changes to the configuration memory (Configuration. Ext., Segment, Configured Quantities, Adding or deleting Loadables etc.), proceeding with this action removes Combined Mode and requires a full online save.

Clearing PLC memory is also not allowed in Combined Mode. Proceeding with this action removes Combined Mode and requires a full online save.

If Combined Mode has been canceled, and a save is attempted, save reads from the PLC memory, not from offline.

If the PLC is in Dim-awareness the Combine Mode will produce an error.

Combined Mode Save

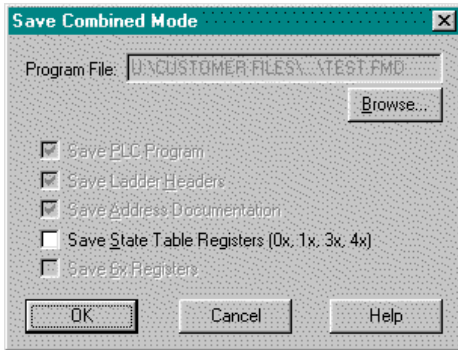

The 3 top check boxes are always checked and disabled. The complete program is always saved. Data values for 0x through 6x are an option. If data is not saved they retain their previous values from the offline file. The **Save 6x Registers** check box is only enabled if 6x registers exist in the PLC.

Transfer Offline Program to Online

PLC WorkShop allows you to transfer an existing offline logic file to an online Modicon controller.

 <h2 style="margin: 0;">Warning</h2>	<p>Editing or modifying a program online may produce unexpected or hazardous results.</p>
---	--

To transfer an existing offline program to online:

1. Select **Transfer** → **Online** from the **File** menu or press [Ctrl+T]. The **Open Program** dialog box appears.

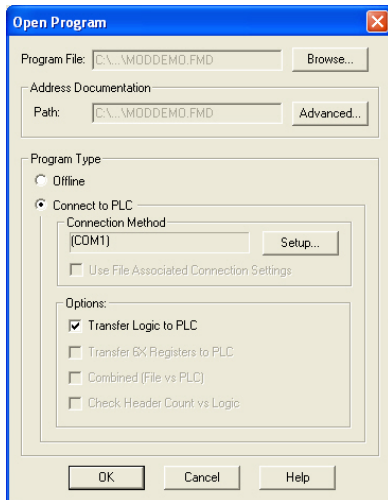

2. Select **OK** to Transfer.

Importing Documentation

Use the following procedure to import documentation.

1. Select **Import** from the **File** menu. The **Import Documentation** dialog box appears.

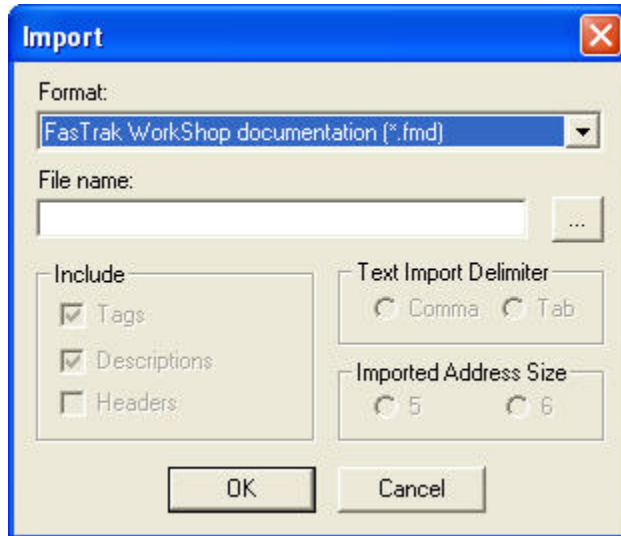

2. Select the type of file to import from the drop down menu.
3. Type the program name in the **Filename** field, or click **Browse** to search from valid program names.
4. Click **OK** to import the program.

The **Include** group box contains three documentation items: **Tags**, **Descriptions**, and **Headers** (Description Comments), which are read when files are imported. Not every item is valid for every import format. And not every format allows these items to be manually selected and unselected. But the items loaded during the import are indicated in this group box.

- Select the **Tags** check box to include them in the documentation import.
- Select the **Descriptions** check box to include them in the documentation import
- Click the **Header** check box (labeled “Description Comments” under the **Taylor ProWORX Symbol .fis Documentation File** format) to include them in the documentation import.

NOTE: For most import formats, these options are checked by default. However, the check box may be selected or unselected under some import formats. When importing Delimited Documentation Text Files, headers must be imported independently of tags and descriptions.

The **Format** combo box of the **Import** dialog offers several file types:

- **FasTrak WorkShop documentation (*.fmd)** - This selection reads documentation from another WorkShop program
- **FasTrak DOS (PLC WorkShop)** - This selection reads documentation from a DOS WorkShop program.

- **Taylor ProWORX/ASCII .fil Documentation File** - This selection reads documentation exported by ProWORX into the Taylor ASCII *.FIL format. The ProWORX “Descriptor” is loaded into the WorkShop Description, the “Short Comment”, “Page Title”, and “Long Comment” are written in that order to the WorkShop Description Comment.
- **Taylor ProWORX Symbol .fis Documentation File** - This selection reads symbol documentation exported by ProWORX into the Taylor *.FIS format. The ProWORX “Symbol” is written to the Workshop Tag; the “Descriptor” is written to the WorkShop Description, the “Short Comment”, “Page Title” and “Long Comment” are written in that order to the WorkShop Description Comment.
- **Modsoft Text Export (Address/Symbol/Descriptor)** - This selection reads the Modsoft Address, Symbol and Descriptor documentation exported into an ASCII text file.
- **Modsoft Text Export (Segment & Network Comments)** - This selection reads the Modsoft Segment and Network Comment documentation exported into an ASCII text file.
- **DMC LadderMaster (ASCII Export)** - This selection reads documentation exported by DMC into an ASCII file.
- **Delimited Documentation Text File** - This selection reads documentation previously exported by FasTrak WorkShop into an ASCII file.
- **4x Register Text File** - This selection reads 4x register data previously exported by FasTrak WorkShop into an ASCII file.

NOTE: FasTrak WorkShop allows only alphanumeric characters and the “_” underscore character in the Tag. The “_” underscore character replaces any other characters imported into the Tag. For example, “ABC%\$#123” would be imported as “ABC__123” The character substitution may create duplicate Tags which would terminate the import process.

When any Tag characters are substituted during documentation import, a message like the one below appears.

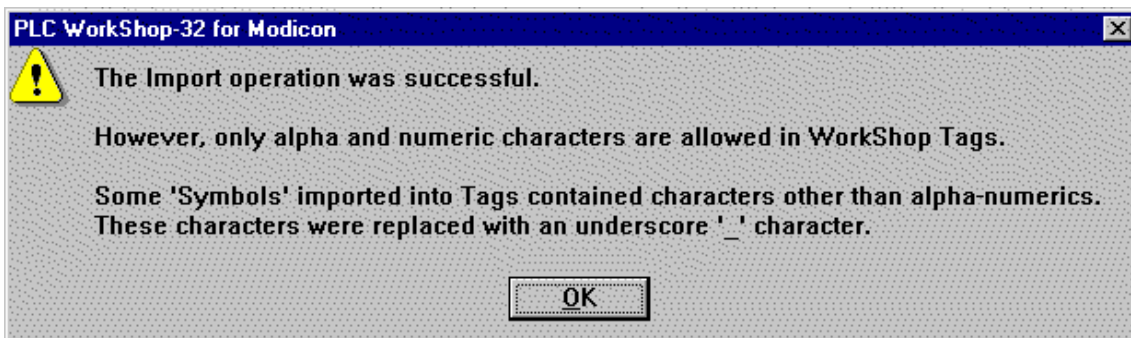

The **Text Import Delimiter** group box contains the two delimiter characters (commas or tab characters), which may be used in certain text import files. These delimiter characters are used to separate fields within each record of these files. The delimiter character may be selected for **Delimited Documentation Text File** and **4x Register Data Test File** formats only.

Use the **Delimited Documentation Text File** format to merge tags, descriptions, and/or headers from the ASCII text files exported from PLC WorkShop into the selected file. You must also select comma or tab delimited records with the following format:

- Characters 1 – 5 or 6 contain the 5 or 6-digit Modicon address.

- Character 6 is the comma or tab character.
- Character 8 and beyond is the variable length tag, followed by the comma or tab character, the variable length description, and a carriage return.
- Headers are imported independently of tags and descriptions. If a header contains a carriage return, double quote characters, or commas, it is surrounded by double quotes. Headers have a maximum length of 16k ASCII characters. A header with no special characters will be stored without double quotes and read to the end of its line.

Exporting Documentation

Use the following procedure to export documentation.

1. Select **Export** from the **File** menu.
2. Select a file format for export from the **Format** combo box.
3. Type the program name in the **Filename** field, or click **Browse** to search from valid program names.
4. Select the parts of documentation to export: **Tags**, **Descriptions**, or **Headers**. Then determine which delimiter format to use. The delimiter is used to separate the types of documentation (Tags, Descriptions or Headers).
5. Click **OK** to export the program.

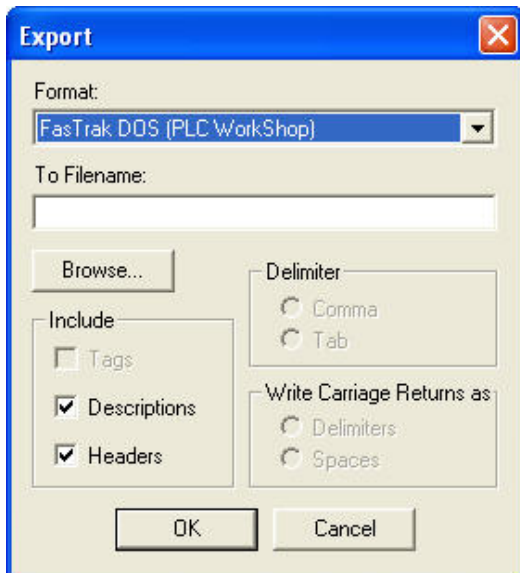

The **Format** combo box of the **Export** dialog offers several file types to which documentation can be written. Documentation to PLC WorkShop, FasTrak's DOS package, can be written directly to the native data files. In addition, documentation can be exported into file formats, which in turn can be imported by competitor's packages.

- **FasTrak DOS (PLC WorkShop)** - This selection writes documentation to a DOS WorkShop program documentation file.
- **Delimited Documentation Text File** - This selection writes documentation, which can be edited externally then, imported back into PLC WorkShop.
- **4x Register Text File** - This selection writes 4x register data, which can be edited externally then imported back into PLC WorkShop.

- **Taylor ProWORX/ASCII .fil Documentation File** - This selection writes documentation into the Taylor ASCII *.FIL format, which can be imported by ProWORX. The WorkShop Description is exported as the ProWORX “Descriptor”, the WorkShop Description Comment is split into the “Short Comment” and “Page Title”. The ProWORX “Long Comment” is stored in a separate ProWORX database file to which the Export process cannot write. Therefore, the “Long Comment” portion of the Description Comment cannot be exported even if it was originally imported from a ProWORX *.FIL.
- **Taylor ProWORX Symbol .fis Documentation File** - This selection writes symbol documentation into the Taylor *.FIS format, which can be imported by ProWORX. The WorkShop Tag is exported as the ProWORX “Symbol”, the Description is exported as the ProWORX “Descriptor”, and the WorkShop Description Comment is split into the “Short Comment” and “Page Title”. The ProWORX “Long Comment” is stored in a separate ProWORX database file to which the Export process cannot write. Therefore, the “Long Comment” portion of the Description Comment cannot be exported - even if it was originally imported from a ProWORX *.FIS.

The **Include** group box contains three documentation items: **Tags, Descriptions, and Headers** (Description Comments), which are written when files are exported. Not every item is valid for every export format. Additionally, not every format allows these items to be manually selected and unselected. But the items written during the export are indicated in this group box.

NOTE: When exporting **Delimited Documentation Text Files**, headers must be exported independently of tags and descriptions. Selecting Header when exporting this format will disable Tags and Descriptions, and vice versa.

Click the **Tags** check box to include them in the documentation export. For most export formats, this option is checked by default. However, this check box may be selected or unselected under some export formats.

Click the **Descriptions** check box to include them in the documentation export. For most export formats, this option is checked by default. However, this check box may be selected or unselected under some export formats.

Click the **Header** check box to include them in the documentation export. For most export formats, this option is checked by default. However, this check box may be selected or unselected under some export formats.

The **Delimiter** group box contains the selection of two delimiter characters (commas or tab characters), which may be used in some text exports files. These characters are used to separate fields within each record of these files. The delimiter character may be selected for **Delimited Documentation Text File** and **4x Register Data Test File** formats only.

Use the Tag/Description Text File to merge Tags or Descriptions from the ASCII text files exported by PLC WorkShop for Windows into the currently opened program. The default file extension is *.TXT but alternate extensions are allowed. You must also select comma or tab delimited records with the following format:

Characters 1 – 5/6 contain the 5/6-digit Modicon address.

Character 6 is the comma or tab character.

Character 8 and beyond is the variable length tag, the comma or tab character, the variable length description, and a carriage return.

When the Taylor ProWORX/ASCII .fil Documentation File or Taylor ProWORX Symbol .fis Documentation File formats are selected, the Descriptor Field Width and Number of Descriptor Fields combo boxes appear within the **Taylor ProWORX** group box below.

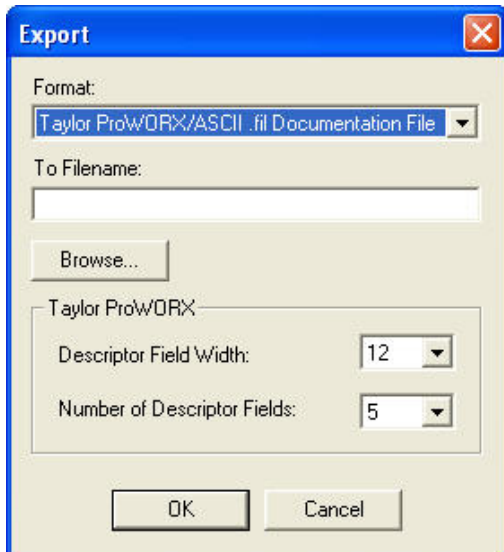

These settings correspond to the same options used in ProWORX to specify the number and length of ProWORX “Descriptor” lines. It is important to select the matching settings so the exported *.FIL or *.FIS files are written in the proper size.

Delimited Documentation Text Format

Documentation exported as delimited text files may be edited in any text editor or spreadsheet application that supports the *.TXT extension. When importing and exporting to this format, headers will be imported and exported as its own file separate from tags and descriptions. After exporting the files, tags, descriptions, and headers can be edited and updated before importing back into the program. While editing delimited documentation, the proper format must be retained for the documentation to be imported correctly.

Tags and Descriptions

Tags and descriptions are exported as comma- or tab-separated values in the following format:

```
address<delimiter> tag<delimiter>description
```

Descriptions that break across multiple lines are also separated into their own comma- or tab-separated values:

Example

```
00001, TAG, This description, is on three, lines
```

```
00002, TAG2, Two line, description
```

Headers

Headers are exported to their own files as comma- or tab-separated values. Network headers, segment headers, and the Title Page may be exported, edited, and imported in the following format:

```
Title<delimiter>
Title description<delimiter>
Seg 1<delimiter>
Segment 1 header<delimiter>
Net 1<delimiter>
Network 1 header<delimiter>
```

Headers that contain newline, double quote characters, commas, or other special characters are surrounded by double quotes inside the delimiters. Headers that do not contain any of these characters contain no double quotes and are only separated by their delimiters. Headers that break across multiple lines are also separated into their own delimited values:

Example

```
Title,
"The first line of the title has a word wrapped in double quotes. ""word""",
"The second line has a comma in it, so it needs to be wrapped in double quotes",
The third line does not have any special chars in it,
Segment 1,
Segment 1 header,
Net 1,
Network 1 header,
Net 2,
Network 2 header. This happens,
To be on 2 lines.,
```

Online Access Modes

PLC WorkShop provides modes for editing ladder logic online, and for monitoring logic online without the risk of inadvertent edits.

Program Mode: allows online editing

Monitor Mode: prevents online editing

Auto Monitor Mode: allows an online editing session, then switches (after a user-defined period of inactivity) to Monitor Mode.

NOTE: The access modes apply only when online. Editing is always possible when offline. In the event of an unintended edit offline, the backup files that PLC WorkShop automatically creates can be used.

Selecting the Initial Online Access Mode

1. Select the **Options/Application Setup** menu option to display the **Application Setup** dialog.

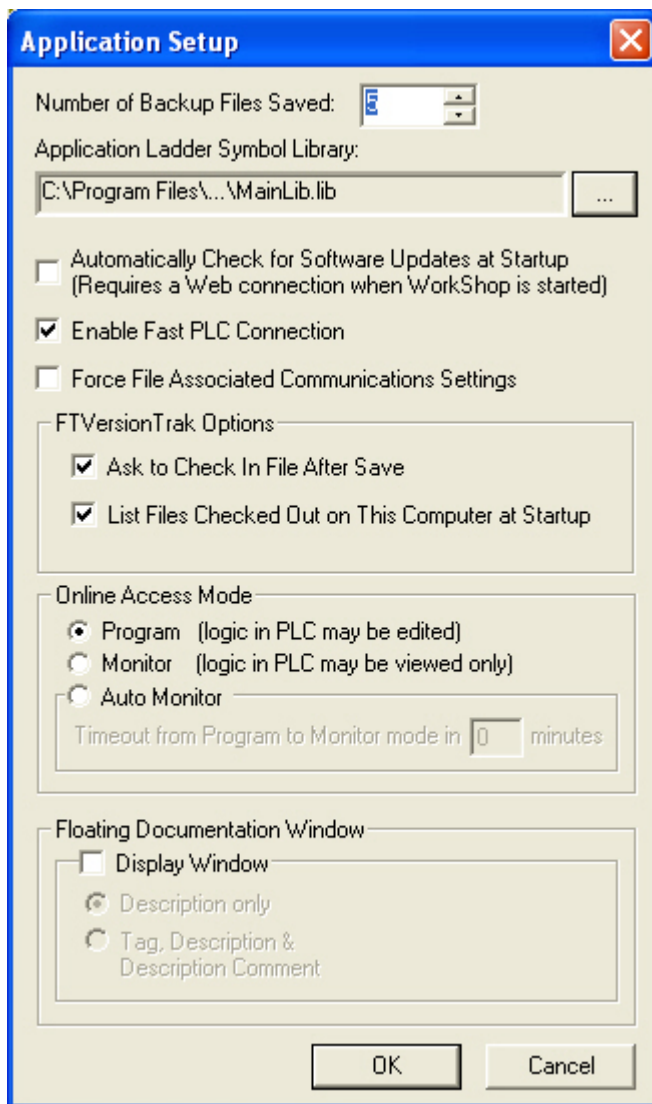

2. Click the option button corresponding to the desired Access Mode.
3. If you selected **Auto Monitor**, enter the number of minutes of inactivity that will indicate that the editing session is over, and cause the switch from Program to Monitor mode. The time selected is the length of inactivity - the user may program indefinitely as long as it is in an uninterrupted session.

Changing the Online Access Mode while online

The current access mode is shown in the title bar.

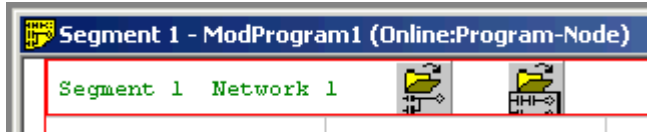

If you attempt to edit online while in Monitor mode, a dialog appears informing you of the fact. If you are in Auto Monitor mode and the programming session has timed out, the dialog includes an option to re-enable Program Mode.

It is also indicated by the presence or absence of a check mark next to the **Program / Program Mode** menu option.

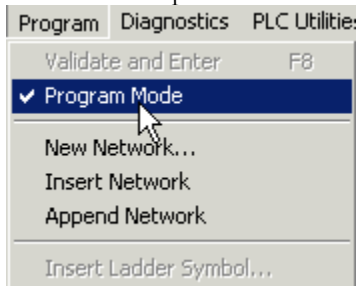

To change the mode while online:

1. Select the **Program/Program Mode** menu option. If Program Mode is active (indicated by a check mark) this switches PLC WorkShop to Monitor Mode. If PLC WorkShop is in Monitor Mode, this switches to Program Mode.

Saving Logic Programs

Use the **Save Program** command to save the active program contents with its existing name. To save the active logic program:

1. Click  on the Toolbar or select **Save Program** from the **File** menu or press [Ctrl+S], and a previously saved logic program is saved.
2. If the program has not been previously saved, the **Save As** dialog box appears. Select the desired location to save the program, and type in a name for the program in the **Filename** field.

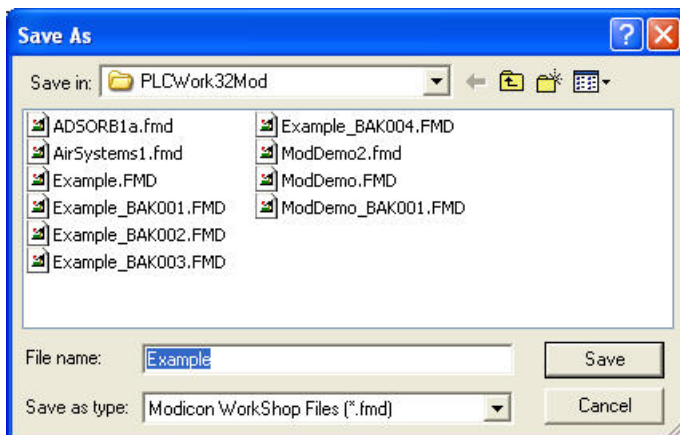

3. Click **Save** or press [Enter] to save the program.
4. If you select a file name that already exists in that directory, a message appears with options. Select from the following options:

YES saves the updated program with the current name, overwriting the previous version.

NO cancels the save procedure.

NOTE: You must validate logic before saving. If you have not done so, a message appears stating changes to logic have not been validated or entered. Changes cannot be saved until logic has been validated and entered. Click **Validate Logic** on the toolbar, or select **Validate and Enter Logic** from the **Program** menu. Complete necessary changes to logic and try to save the program again.

Save/Save As Online

Use the online **Save Program** command to save all the active program contents with its existing name or parts of an existing logic program. One or more of the following parts can be saved:

- PLC Program
- Save Ladder Headers
- Save Address Documentation (Tags, Descriptions, Comments and Headers)
- Save 6x Registers

To save the active logic program:

1. Click  on the Toolbar or select **Save Program** from the **File** menu [Ctrl+S]. The **Save** dialog box appears.

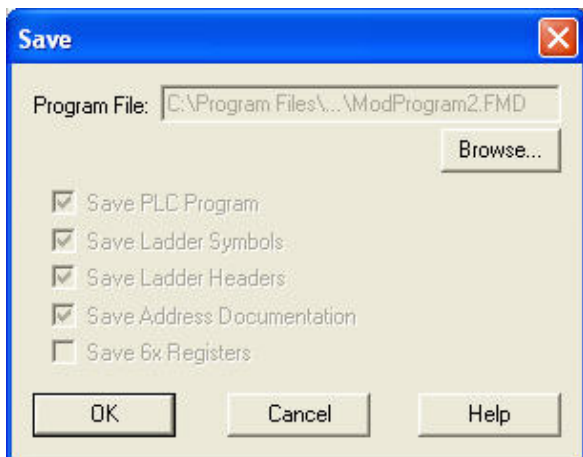

2. Deselect the parts of the program you do not wish to save.
3. If the program has not been previously saved or you wish to change the file name, select the Browse button, and type in a name for the program in the **Filename** field.
4. Click **Save** or press **Enter** to save the program.
5. If you select a file name that already exists in that directory, a message appears with options. Select from the following options:
 - **YES** saves the updated program with the current name, overwriting the previous version.

- **NO** cancels the save procedure.

NOTE: You must validate logic before saving. If you have not done so, a message appears stating changes to logic have not been validated or entered. Changes cannot be saved until logic has been validated and entered. Click **Validate Logic** on the toolbar, or select **Validate and Enter Logic** from the **Program** menu. Complete necessary changes to logic and try to save the program again.

If you are working online and saving your changes, a warning message appears stating that logic in the active PLC program has been modified, and asks if you wish to save the logic in addition to tags and documentation.

Click **Yes** to save logic, tags, and documentation. Click **No** to save documentation and tags only. Cancel aborts the save procedure.

If you are saving documentation to an online logic program and the last network header exceeds the number of networks/addresses, an error message appears.

 Warning	Editing or modifying a program online may produce unexpected or hazardous results.
--	---

Save Program As Offline

Use **Save Program As** to save the active logic program with a different program name. This is useful when maintaining the original without changes. For example, open file ABC.FMD, make changes, select **Save Program As**, and save the program as DEF.FMD. Now you have two files, ABC.FMD retained its same condition before you opened it, and DEF.FMD that contains changes made to ABC.FMD.

NOTE: You must validate logic before saving. If you have not done so, a message appears stating changes to logic have not been validated or entered. Changes cannot be saved until logic has been validated and entered. Click **Validate Logic** on the toolbar, or select **Validate and Enter Logic** from the **Program** menu. Complete necessary changes to logic and try to save the program again.

To save a logic program with a new file name:

1. Select **Save As** from the **File** menu. The **Save As** dialog box appears.

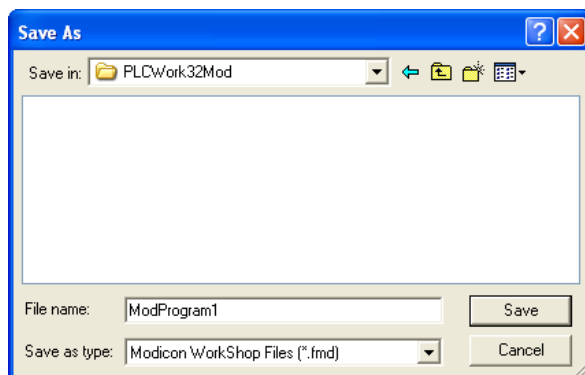

2. In the **Save As** dialog box, click options in the necessary group boxes to designate a location to save the logic program.
3. Click **OK** or press [Enter]. Your file is saved with its new name.

4. If you select a file name that already exists in that directory, a message appears with options. Select from the following options:
 - **YES** saves the updated program with the current name, overwriting the previous version.
 - **NO** cancels the save procedure.

NOTE: If you are saving documentation to an online program, please see *Saving Online* under *Saving Logic Programs* on the preceding pages.

Automatic Backup

WorkShop automatically maintains a rolling set of backup files each time a PLC program is saved.

When a PLC program is saved, the previous version is renamed to the existing file name with BAK001 appended. Any existing backup files are renamed with a number one higher, up to the number of backups that have been defined. See *Setting Maximum Number of Backup Files*.

For example, if a program named MyProg.fmd is saved, and the number of backups is set to 5:

The current file	Becomes
MyProg.fmd	MyProgBAK001.fmd
MyProgBAK001.fmd	MyProgBAK002.fmd
MyProgBAK002.fmd	MyProgBAK003.fmd
MyProgBAK003.fmd	MyProgBAK004.fmd
MyProgBAK004.fmd	MyProgBAK005.fmd
MyProgBAK005.fmd	Is not saved

Setting Maximum Number of Backup Files

The default maximum number of backup files maintained for each *.FMD file is five. This value may be set to any integer between 0 and 999. This setting applies to all *.FMD files and is not specific to only the current file.

To specify the maximum number of backup files:

1. Select the **Options/Application Setup** menu item. The **Application Setup** dialog appears.

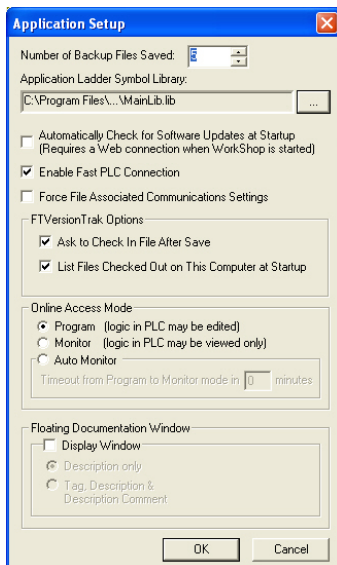

2. Enter a value in the **Number of Backup Files Saved** edit box.

NOTE: To deactivate the *.FMD file backup feature, set the **Number of Backup Files Saved** to zero.

Opening a Backup File

Backup files (whose names end in **_BAKxxx.FMD**) may be opened using the **File/Open** menu item. Once opened, backup files may be viewed and edited just like the original ladder program from which they were created.

Backup files cannot be saved again with the same backup file name. Attempting to re-save a backup file displays a similar error message:

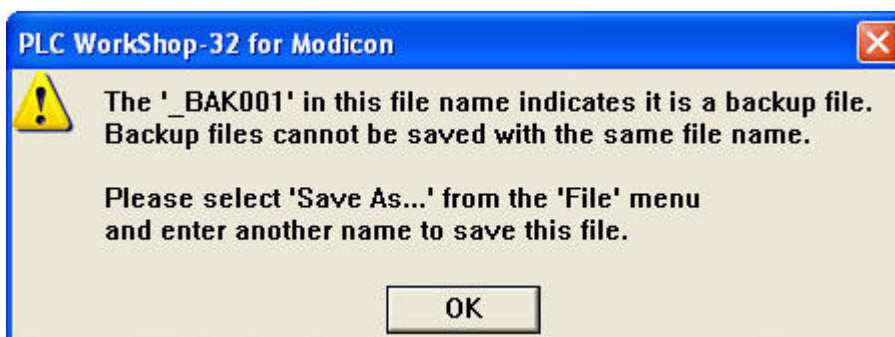

To re-save the backup file, select the **File/Save As** menu item and enter another file name.

Printing Logic Programs

PLC WorkShop provides you with a number of print features that allow customization of your printouts. These include:

Specific Print Selections

- Logic
- PLC Configuration
- Registers
- Documentation
- Cross Reference
- Disabled States
- ASCII Messages

Customizable Options

- Output to Text File
- Documentation Font
- Edit Title Page

Before you can print, open a logic program. Make certain that you have loaded the correct print drivers for your printer through the Windows Control Panel. If you have questions regarding loading print drivers, consult your printer's user's manual and the Windows User's Guide.

To print logic programs and/or documentation:

1. Access the appropriate **Print** dialog by selecting either **Print** or **Print Preview** from the **File** menu or by pressing [Ctrl+P].

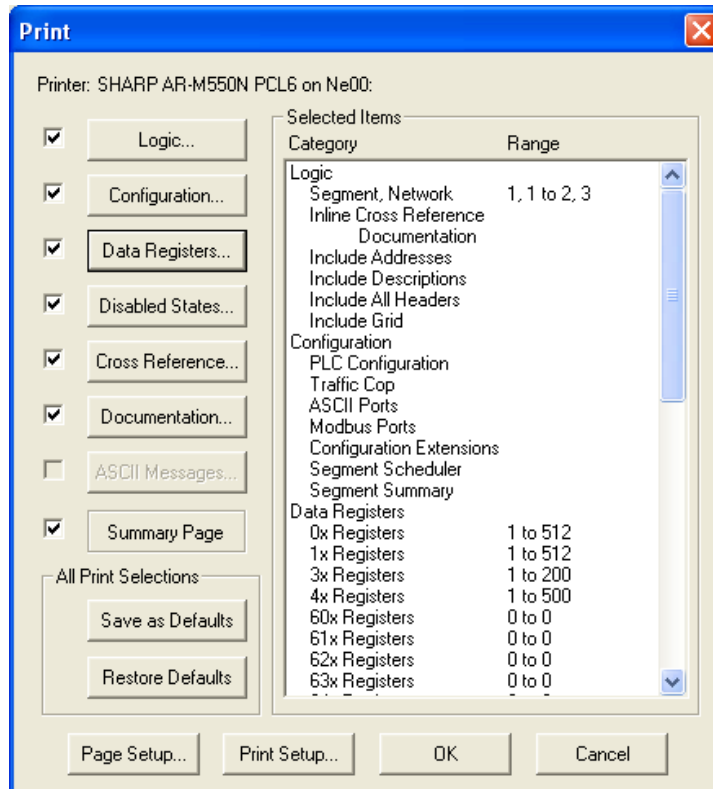

2. Click on the check boxes that correspond to the items you want to print. For each item selected, you can choose sort options and the information you want to include for reports. The **Selected Items** window displays the print range of each print item to be printed.

Print Logic

Select the **Logic** check box within the **Print** dialog to print the following:

- All ladder logic
- Selected ladder logic
- Inline Xref
- Ladder with Addresses, Tags, Descriptions, or Headers
- Multiple or single networks per page

To display the **Print Logic** options:

1. Access the appropriate **Print** dialog by selecting either **Print** or **Print Preview** from the **File** menu or by pressing [Ctrl+P].
2. Click the **Logic** button within the **Print** dialog. The **Print Logic** dialog appears.

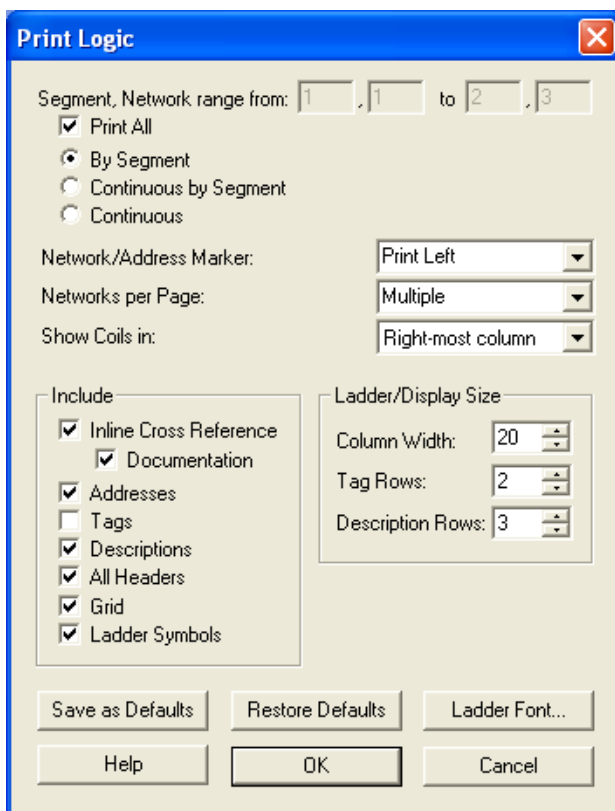

The **Print Logic** dialog box determines which items are printed.

3. Configure the following options for the Logic printout:
 - Click the **Print All** check box to print the entire range of ladder selected.
 - To print a selection range, deselect the Print All check box and enter a range in the associated **Segment, Network range** box.
 - If you selected to print **By Segment**, the **from** and **to** segment and network numbers can be entered. Each segment's starting network will always start with 1.
 - If **Continuous by Segment** radio button is selected, only **from** and **to** segment numbers can be entered. The first network in the first segment is numbered 1. All other networks are numbered continuously. The first network of the next segment is numbered 1 plus the preceding segment's last network number.
 - If **Continuous** radio button is selected, only **from** and **to** network numbers can be entered. The first network in the first segment is numbered 1. All other networks are numbered continuously. The first network of the next segment is numbered 1 plus the preceding segment's last network number.

- When selecting **Networks per Page** as **Single** or **Multiple**, use the following information:

When printing **Single Networks per Page**, each network begins on a new page. When printing **Multiple Networks per Page**, as many networks that can fit on a single page will be printed. However, if the network is not the first network on the page and the network is broken across more than one page but can fit on a single page and if it would start a new page, then the network begins on a new page. The intent is to keep the entire network on one page whenever possible.

- To change the Tag, Description, and Comments printed font of the active program, click the **Doc Font** button. (See *Configuring Documentation Font*.)

NOTE: The print selection options are stored when saving a program.

Print PLC Configuration

Click the **Configuration** check box from the **Print** dialog to print the following:

- PLC Configuration
- Traffic Cop
- ASCII Ports
- Modbus ports
- Configuration Extensions
- Segment Scheduler
- Segment Summary

To change the PLC Configuration properties click the **PLC Configuration** button on the **Print** dialog box. The **Print PLC Configuration** dialog box appears.

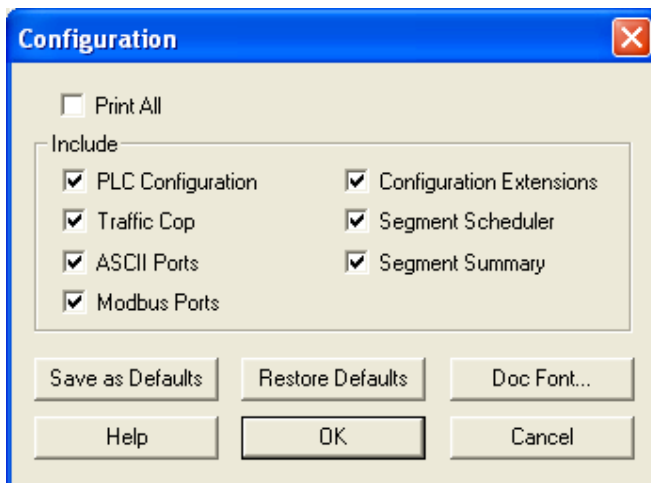

Click the **Print All** check box to print the entire range of items. To print a selection, deselect the **Print All** check box and enter a range in the associated edit box.

To change the Tag, Description, and Comments printed font of the active program, click the Doc Font button. (See *Configuring Documentation Font*.)

NOTE: The print selection options are stored when saving a program.

Print Registers

Click the **Register** check box from the **Print** dialog box to print the following:

1. 0x, 1x, 3x, 4x and/or 6x

To change the Register properties:

1. Click the **Register** button on the **Print** dialog box. The **Print Register** dialog box appears.

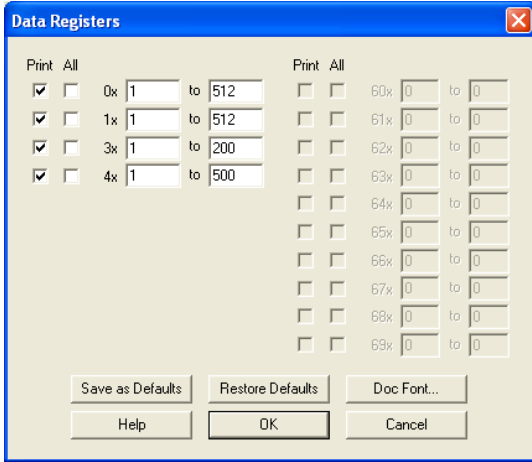

2. Click the **All** check box to print the entire range of items. To print a selection, deselect the **All** check box and enter a range in the associated edit box.
3. The tags and descriptions can be individually turned on or. To include with the Register print out select the appropriate check box under **Include**.
4. To change the Tag, Description, and Comments printed font of the active program, click the **Doc Font** button. (See *Configuring Documentation Font*.)

NOTE: The print selection options are stored when saving a program.

Print Documentation

Click the **Documentation** check box from the **Print** dialog box to print the following:

- 0x, 1x, 3x, 4x and/or 6x Documentation
- Register Tags, Descriptions, Comments, and Values

To change the Documentation properties:

1. Click the **Documentation** button on the **Print** dialog box. The **Print Documentation** dialog box appears.

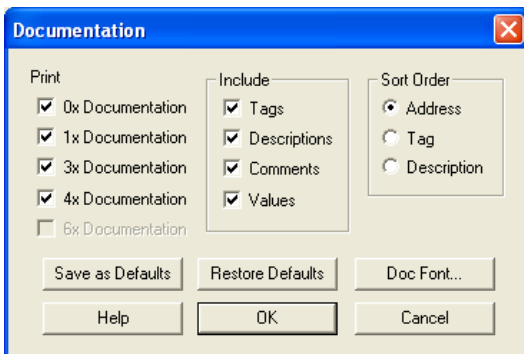

Click the register check box to print the entire range of registers.

The Register **Tags**, **Descriptions**, **Comments**, and **Values** can be individually turned on and off. To include with the Documentation print out select the appropriate check box under **Include**.

The sort order for documentation print can be based on **Address**, **Tag**, or **Description**. To change the Documentation print sort orders select the appropriate check box under **Sort Order**.

NOTE: The print selection options are stored when saving a program.

Print Cross Reference

Select the **Cross Reference** check box within the **Print** dialog to print the following.

- 0x, 1x, 3x, 4x and/or 6x
- Tags, Descriptions, and Comments
- Coils Used

To change the Cross Reference properties:

1. Access the appropriate **Print** dialog by selecting either **Print** or **Print Preview** from the **File** menu or by pressing [Ctrl+P] .
2. Click the **Cross Reference** button within the **Print** dialog. The **Print Cross Reference** dialog appears.

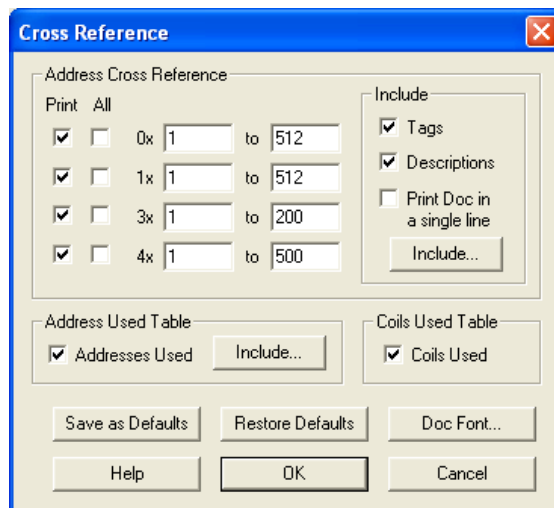

3. Configure the following options for the Cross Reference printout.

To print the entire range of items, click the **All** check box. To print a selection, deselect the **All** check box and enter a range in the associated edit box.

To include **Tags**, select the **Tags** check box within the Include group box.

To include **Descriptions**, select the **Descriptions** check box within the Include group box.

To print address documentation in a single line with the Address, select the **Print Doc** in a single line check box.

Click the **Include** button to select addresses located in other parts of the program.

To include the **Addresses Used Table** with the Cross Reference printout, select the **Addresses Used** check box. Click the **Include** button to select addresses located in other parts of the program.

To include the **Coils Used Table** with the Cross Reference printout, select the **Coils Used** check box.

To change the Tag, Description, and Comments printed font of the active program, click the **Doc Font** button. (See *Configuring Documentation Font*.)

NOTE: The print selection options are stored when saving a program.

Print to a Text File

- To print to a text file, select **Output To Text File** from the **File** menu. The **Print Output to Text File** dialog box appears.

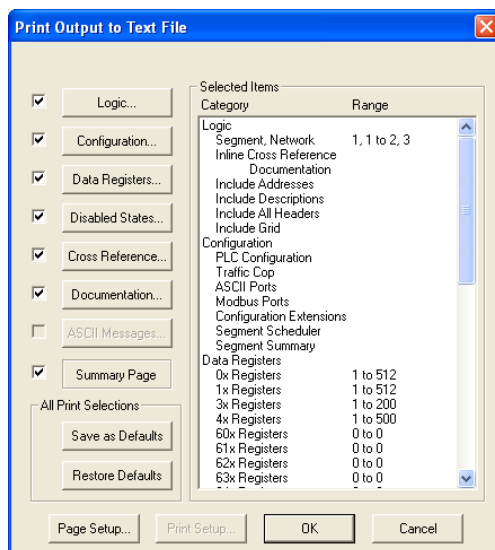

See *Printing Logic Programs* for dialog box selections.

- Once selections are made select **OK**.
- Enter a file name to save to and select **OK**.

Print Disabled States

Click the **Disabled States** check box from the **Print** dialog box to print the following:

- 0x and/or 1x disabled states

To change the **Disabled States** print properties:

- Click the **Disabled States** button on the **Print** dialog box. The **Print Disabled States** dialog box appears.

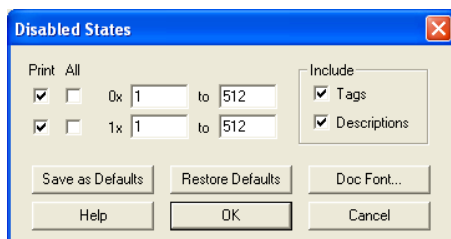

- Click the **All** check box to print the entire range of items. To print a selection, deselect the **All** check box and enter a range in the associated edit box.

The following can be individually turned on and off to be included with the Disabled States printout:

- Tags
 - Descriptions
- To change the Tag, Description, and Comments printed font of the active program, click the **Doc Font** button. (See *Configuring Documentation Font*.)

NOTE: The print selection options are stored when saving a program.

Print ASCII Messages

To print ASCII messages:

- Click the **ASCII Messages** check box from the Print dialog box.
- To change the ASCII Messages print properties click the **ASCII Messages** button on the **Print** dialog box. The **Print ASCII Messages** dialog box appears.

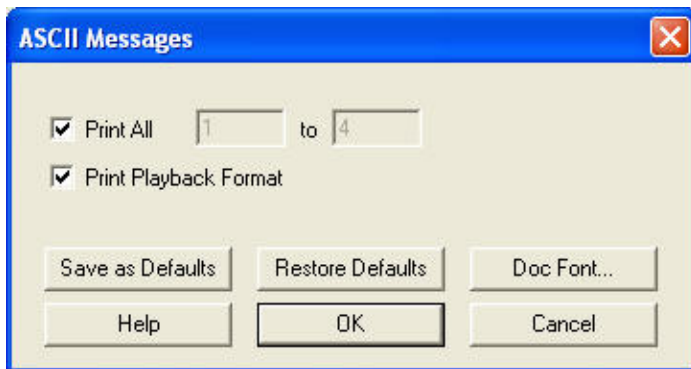

- Click the **All** check box to print the entire range of items. To print a selection, deselect the **All** check box and enter a range in the associated edit box. Selecting the **Playback Format** check box can also print the playback format.
- To change the Tag, Description, and Comments printed font of the active program, click the **Doc Font** button. (See *Configuring Documentation Font*.)

NOTE: The print selection options are stored when saving a program.

Configuring Documentation Font

Font, font style, and font size for documentation (tags, descriptions, and comments) can be customized.

To change the documentation font:

- Access the appropriate **Print** dialog by selecting either **Print** or **Print Preview** from the **File** menu or by pressing [Ctrl+P] .
- Click the **Logic**, **Configuration**, **Data Registers**, **Disabled States**, **Cross Reference**, or **Documentation** button to access the applicable dialog.

3. Click the **Doc Font** button. The **Font** dialog appears.

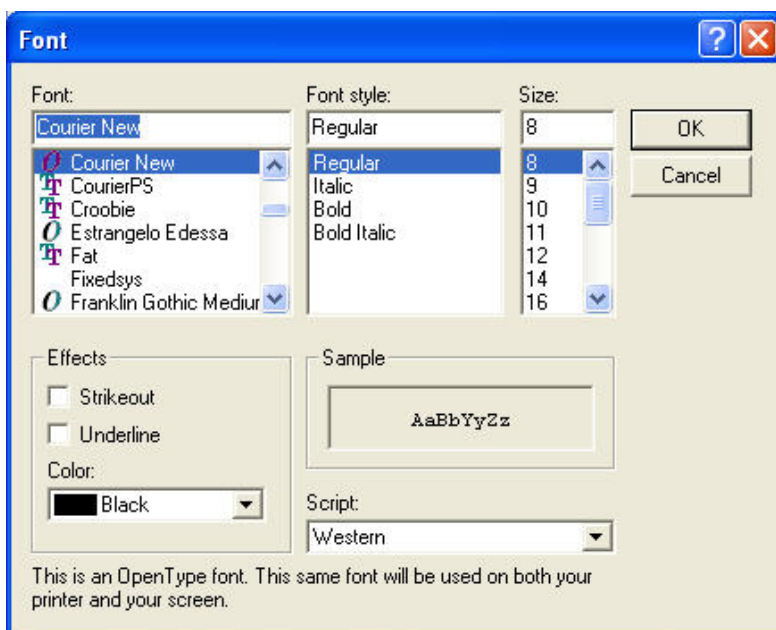

4. Configure font options.

NOTE: The print selection options are stored when saving a program.

Editing Features

PLC WorkShop uses a number of timesaving editing features to help you complete your programming tasks. These include:

- Cut
- Copy
- Paste
- Paste With Rewire
- Replace Table
- Undo
- Clear
- Delete
- Insert

The most frequently used editing features are **Cut**, **Copy**, and **Paste**. Use these commands to quickly copy logic and documentation to either another location in the same program or another program. The list below describes Cut, Copy, and Paste differences.

Window Feature	Function
Cut	Removes the selection from the program and places it on the clipboard.

Copy	Copies the selection and places it on the clipboard.
Paste	Inserts clipboard contents into the program at the cursor location.
Paste With Rewire	Inserts clipboard contents into the program at the cursor location and allows the user to re-address any addressable items contained in the clipboard.
Replace Table	Replaces addresses and discrete instructions with alternate addresses
Undo	Resets the networks/addresses in a segment to their original data.

The clipboard referenced is the standard Windows clipboard. Refer to your *Windows User's Guide* for more information.

To select the information to be cut or copied, click, hold and drag the pointer over the desired area. Selected items are highlighted with a different color than your normal workspace color. Select the appropriate check box to include **Address Documentation** or **Ladder Symbols**.

If you want to select all logic in the current window, select the **Edit / Select All** menu item.

Each of three editing commands, described in detail in the following paragraphs, can be accessed several ways.

Cut

To use the cut feature:

1. Select the information you want to cut by highlighting the instruction, group of instructions or networks to be cut.
2. Click and hold down the left mouse button on the item, or network lines to be cut, then drag the mouse to the end of the item range or network lines to cut.
3. Cut your selection to the clipboard with one of the following:
 - Click  on the toolbar or
 - Select **Cut** from the **Edit** menu
 - Press [Ctrl+X]

NOTE: If the start and ending network number is known then the **cut from** and **cut to** range can be entered directly into the **Cut** dialog box. If a partial network is selected, the **Cut** dialog box is not displayed. The items selected are cut without warning.

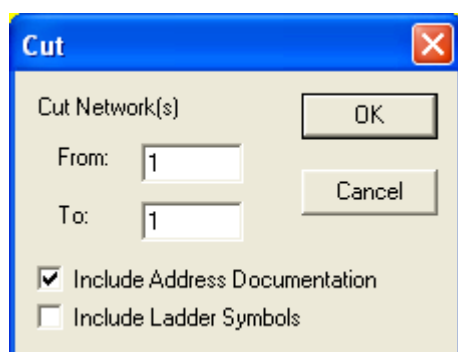

4. Select **OK**. The range of networks/addresses displayed are cut out of the program and placed into the clipboard.

Copy

To use the copy feature:

1. Select the information you want to copy by highlighting the instruction, group of instructions or networks to be copied.
2. Click and hold down the left mouse button on the item, or network to be copied, then drag the mouse to the end of the item range or network to copy.
3. Copy your selection to the clipboard with one of the following:
 - Click  on the toolbar or
 - Select **Copy** from the **Edit** menu
 - Press [Ctrl+C]

NOTE: If the start and ending network number is known then the **copy from** and **copy to** range can be entered directly into the **Copy** dialog box. If a partial network is selected, the **Copy** dialog box is not displayed. The items selected are copied without warning.

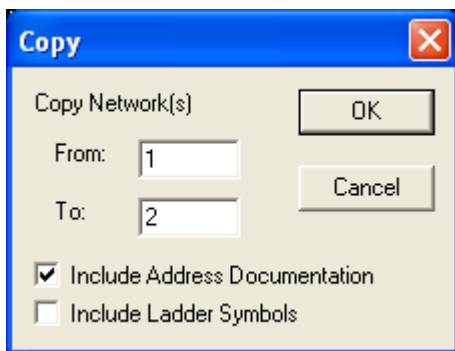

4. Click **OK**. The range of networks/addresses displayed are copied and placed into the clipboard.

Paste

To access the paste feature:

1. Move the cursor to the desired location.
2. Paste clipboard contents into the new location with one of the following:
 - Click  on the toolbar
 - Select **Paste** from the **Edit** menu
 - Press [Ctrl+V]

Paste With Rewire

Paste With Rewire provides you with a number of time-saving editing features. These include:

- Paste multiple copies
- Paste with address offset

- Include tags and descriptions in the paste
- The ability to Rewire (change address) on an individual basis

To access the rewire feature:

1. Move the cursor to the desired location.
2. Paste clipboard contents into the new location by:
 - Selecting **Paste with Rewire** from the **Edit** menu. The **Paste With Rewire** dialog box appears.
 - Choose the appropriate options.
 - Click **OK**.

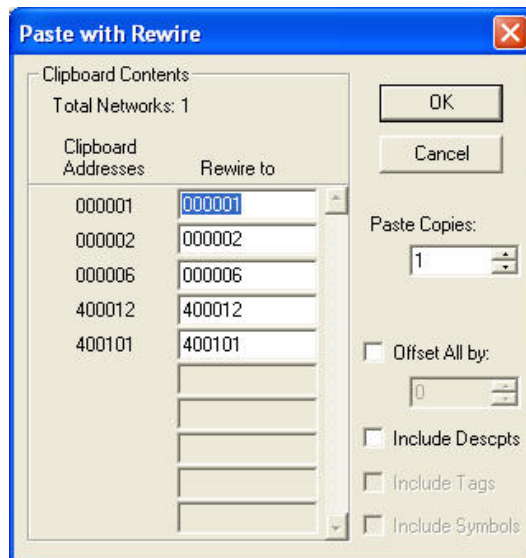

NOTE: When pasting, clipboard contents are inserted before existing items. For example, if you are pasting a network and the cursor is positioned at Network 002, click paste and the clipboard contents become Network 002. The previous Network 002 becomes Network 003.

If the **Copy/Cut buffer** was copied with ladder symbols then rewire will enable the ability to paste symbols to for the rewired address. A check is done before the actual paste of the rewired network to see if any symbols being written to already have a ladder symbol. If a Symbol exists for any rewired address the user is warned:

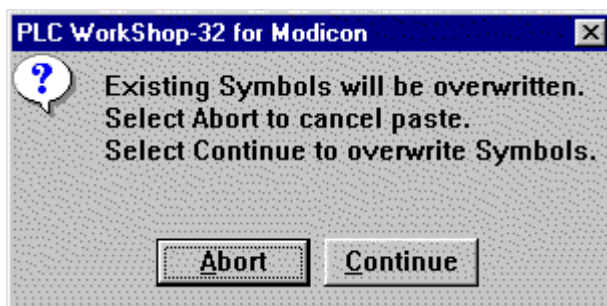

Abort ends the rewire.

Special Paste

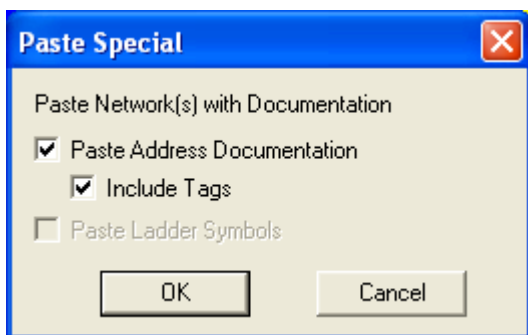

The regular **Paste** command does not paste **Address Documentation** or **Ladder Symbols**. If the **Copy/Cut buffer** was copied with Ladder Symbols and/or address documentation, then **Special Paste** can paste them.

Paste of address documentation has two checks. If any tags exist for the pasted address documentation then the user is given a warning:

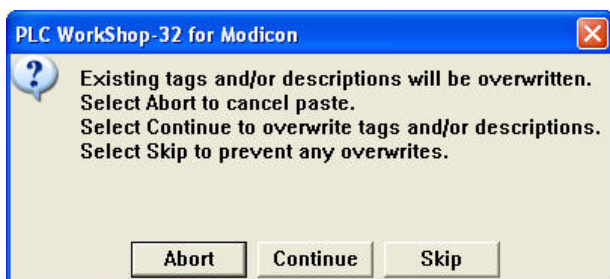

Replace Table

Replace Table allows up to 24 ranges of 0x, 1x, 3x, and 4x addresses and Contact and Coil instructions within a ladder program to be replaced. This is an offline feature and only available in unedited (entered and validated) programs.

For example, every address from 000012 through 000016 could be replaced with addresses 000100 through 000104. This means the Replace Table replaces every occurrence of the discrete address as follows:

000012 is replaced with 000100

000013 is replaced with 000101

000014 is replaced with 000102

000015 is replaced with 000103

000016 is replaced with 000104

Similarly, specific instructions within a range of addresses can also be replaced.

For example, every Normally Open (N/O) Contact whose address is within 101023 through 101027 can be replaced with a Normally Closed (N/C) Contact from 000566 through 000570. This means the Replace Table replaces every occurrence as follows:

N/O Contact 101023 is replaced with N/C Contact 000566

N/O Contact 101024 is replaced with N/C Contact 000567

N/O Contact 101025 is replaced with N/C Contact 000568

N/O Contact 101026 is replaced with N/C Contact 000569

N/O Contact 101027 is replaced with N/C Contact 000570

When replacing instructions within an address range, only addresses used in the selected instruction type are replaced. Occurrences of addresses within the specified range are not replaced if they are not used in the selected instruction type.

For example, when replacing Normally Open Contacts that use addresses 101023 through 101035, address 101023 used in a Move instruction is not replaced because a Move instruction is not a Normally Open Contact instruction.

Similarly continuing the example above, a Normally Open Contact whose address is 101022 is not replaced because address 101022 is outside the specified replace range.

NOTE: Addresses within Configuration, Configuration Extension, and Traffic Cop are not replaced.

To use the replace feature, select the **Edit/Replace Table** menu item. The **Replace Table** dialog appears.

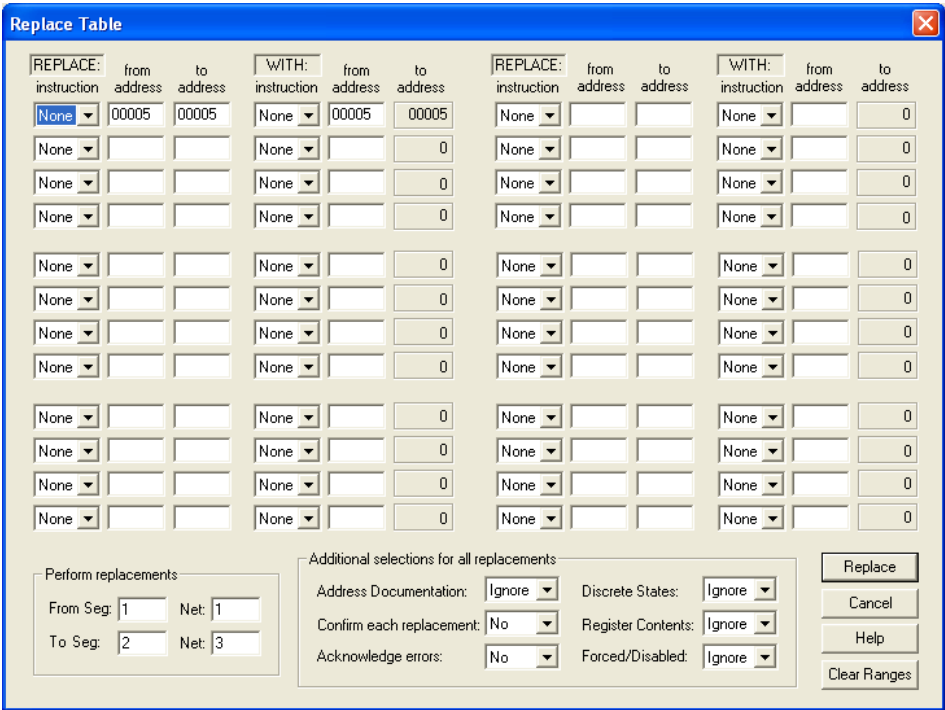

The Replace Table dialog allows up to 24 separate address or instruction/address groups to be replaced at one time. Replacements are performed from the top to the bottom of the left column followed by the top to the bottom of the right column.

NOTE: While WorkShop is running, the Replace Table settings are saved and restored for each program. When the dialog is displayed, selections made the last time it was used are automatically restored. These settings are cleared when WorkShop is terminated.

Replacing an Address / Address Range

To replace an address range:

1. Use the default setting of **None** in the **REPLACE instruction** combo box.
2. Enter the address / address range to be replaced in the **from address** and **to address** edit boxes. These addresses must be of the same type and within the **Configured Quantities** shown in the PLC Configuration dialog, which is accessed through the **PLC Utilities / PLC Configuration** menu item. If both the **REPLACE to address** and **WITH from address** edit boxes are empty when a **REPLACE from address** is entered, the **REPLACE from address** is copied into the **REPLACE to address** and **WITH from address** edit boxes by default.
3. Use the default setting of **None** in the **WITH instruction** combo box.
4. Enter the replacement starting address in the **from address** edit box. 0x and 1x address types may only be replaced with 0x and 1x address types. Likewise, 3x and 4x address types may only be replaced with 3x and 4x address types. The **WITH to address**, containing the ending address of the range, is automatically calculated based upon the number of addresses in the **REPLACE from address** and **to address** range.
5. Click the **Replace** button to start the replacement process.

Replacing an Address / Address Range associated with an Instruction

To replace an instruction:

1. Select an **Instruction Type**, for the instruction to be replaced, from the **REPLACE instruction** combo box by selecting the instruction's corresponding mnemonic. Choices include:

Coil: **-()-**

Latched Coil: **-(L)-**

Normally Open Contact: **-] [-**

Normally Closed Contact: **-] / [-**

Up-Transition Contact: **-] ^ [-**

Down-Transition Contact: **-] v [-**

2. Enter the address range to be replaced in the **from address** and **to address** edit boxes. Only 0x and 1x addresses may be entered. These addresses must be of the same type and within the **Configured Quantities** shown in the **PLC Configuration** dialog, which is accessed through the **PLC Utilities / PLC Configuration** menu item. If both the **REPLACE to address** and **WITH from address** edit boxes are empty when a **REPLACE from address** is entered, the **REPLACE from address** is copied into the **REPLACE to address** and **WITH from address** edit boxes by default.
3. Select an **Instruction Type**, for the replacement instruction, from the **WITH instruction** combo box by selecting the instruction's corresponding mnemonic.
4. Enter the replacement starting address in the **from address** edit box. 0x and 1x address types may only be replaced with 0x and 1x address types. The **WITH to address**, containing the ending address of the range, is automatically calculated based upon the number of addresses in the **REPLACE from address** and **to address** range.

5. Click the **Replace** button to start the replacement process.

Limiting Replacements to Specific Segments or Networks

To limit replacements to specific segments or networks:

1. Enter the starting segment/network to be replaced in the **Perform replacements From Seg/Net** edit box.
2. Enter the ending segment/network to be replaced in the **Perform replacements To Seg /Net** edit box.

NOTE: Neither value may exceed the total number of segments / networks contained in the program.

Address Documentation

To copy or move address documentation associated with addresses that have been replaced, select the appropriate option from the **Address Documentation** combo box, within the **Additional selections for all replacements** group box.

Move: The Tags, Descriptions, and Description Comments from the original **REPLACE** addresses are copied to the **WITH** addresses, and the documentation of each **REPLACE** address is deleted from the address documentation database.

Copy: The Descriptions and Description Comments from the original **REPLACE** addresses are copied to the **WITH** addresses, and the documentation of each **REPLACE** address remains unchanged in the address documentation database. Tags are not copied since every Tag must be unique in the address documentation database.

Ignore: Existing address documentation of both the **REPLACE** and **WITH** addresses remains unchanged in the address documentation database.

NOTE: Address documentation is copied or moved during a separate operation only after all addresses and/or instructions have been replaced in the logic.

Confirmation

To confirm replacements, select the appropriate option from the **Confirm each replacement** combo box, within the **Additional selections for all replacements** group box.

Yes: Requires user confirmation before replacing any address or address/instruction combination.

No: Replacements are made without requesting user confirmation.

Error Acknowledgement

To acknowledge errors, select the appropriate option from the Acknowledge errors combo box, within the Additional selections for all replacements group box.

Yes: The Replace Table displays messages regarding any errors encountered during the replace process and waits for user confirmation.

No: The Replace Table ignores any errors encountered during the replace process and continues until all replacements are complete.

NOTE: Any replacement that causes an error is not performed.

Discrete Address States

To manipulate discrete address states associated with addresses that have been replaced, select the appropriate option from the **Discrete States** combo box, within the **Additional selections for all replacements** group box.

Move: The states of the original **REPLACE** addresses are copied to the **WITH** addresses, and the states of the **REPLACE** addresses are zeroed.

Copy: The states of the original **REPLACE** addresses are copied to the **WITH** addresses, and the original **REPLACE** states remain unchanged.

Ignore: Existing states of both the **REPLACE** and **WITH** addresses remain unchanged.

NOTE: Discrete states are copied or moved during a separate operation only after all addresses and/or instructions have been replaced in the logic.

Register Addresses

To manipulate register addresses associated with addresses that have been replaced, select the appropriate option from the **Register Contents** combo box, within the **Additional selections for all replacements** group box.

Move: The register contents of the original **REPLACE** addresses are copied to the **WITH** addresses, and the register contents of the **REPLACE** addresses are zeroed.

Copy: The register contents of the original **REPLACE** addresses are copied to the **WITH** addresses, and the original **REPLACE** register contents remain unchanged.

Ignore: Existing register contents of both the **REPLACE** and **WITH** addresses remain unchanged.

NOTE: Register contents are copied or moved during a separate operation only after all addresses and/or instructions have been replaced in the logic.

Forced / Disabled Address States

To manipulate forced/disabled address states associated with addresses that have been replaced, select the appropriate option from the **Forced / Disabled** combo box, within the **Additional selections for all replacements** group box.

Move: The forced/disabled states of the original **REPLACE** addresses are copied to the **WITH** addresses, and the forced/disabled states of the **REPLACE** addresses are zeroed.

Copy: The forced/disabled states of the original **REPLACE** addresses are copied to the **WITH** addresses, and the original **REPLACE** forced/disabled states remain unchanged.

Ignore: Existing states of both the **REPLACE** and **WITH** addresses remain unchanged.

NOTE: Forced/disabled states are copied or moved during a separate operation only after all addresses and/or instructions have been replaced in the logic.

Undo

Use Undo to reset networks in a segment to their original data. Any modified or inserted rung can be reset. Deleted rungs cannot be reset.

To access the Undo feature:

1. Select **Undo** from the **Edit** menu or press [Ctrl+Z]. The **Undo Logic** window appears.

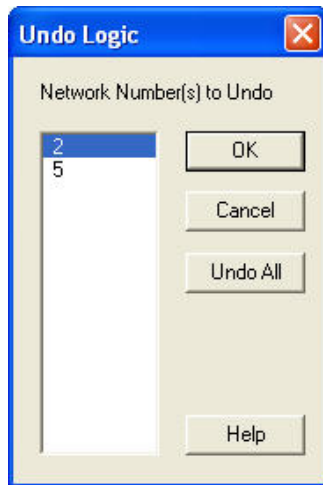

2. Select the segments to reset and press **OK**, or press **Undo All** to reset all networks displayed.
3. Click **Cancel** to close the window.

Clear

Use **Clear** to clear an item without removing the space it occupies. Access **Clear** from the **Edit** menu using the **Logic Editor** in either offline or online mode. **Clear** can also be accessed from the **Data Window**.

To clear items:

1. Select the item or items you want to clear by clicking, holding, and dragging the pointer over the desired logic.

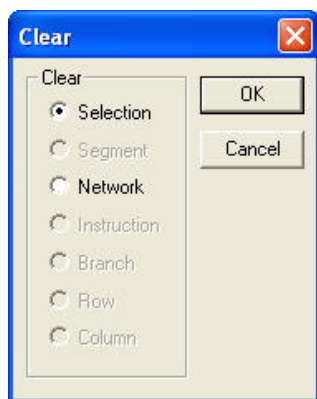

2. Select **Clear** from the **Edit** menu or press the [Delete] key. The **Clear** dialog box appears.
3. Click the items you want to clear.
4. Click **OK** or press [Enter]. The selected items are cleared.

The following table describes the clearing items.

Item	Function
Ladder	Removes all networks from the block displayed.
Network	Removes all logic from the network at the cursor position.
Instruction	This option is available if the cursor is positioned at an instruction. When cleared, the instruction is removed; however, attached branches are not affected.
Branch	This option is available if there is a branch to the right of the instruction with the cursor. Clearing removes the branch to the right of the cursor.
Row	This option is available when an instruction is selected. Clearing removes instructions from the row where the cursor is positioned. Branches in this row are cleared only if the resulting logic contains branches unconnected to logic at one or both ends.
Column	This option is available when an instruction is selected. Clearing removes instructions and branches from the current column.

Logic Editor - Online

Using **Clear** in the Logic Editor while online works the same as in offline mode. However, row and column cannot be cleared while online.

Data Window

While working in the Data Window, you can use **Clear** to clear all rows or one row at a time. Clear is accessed through the **Edit** menu or by pressing the [Delete] key.

Delete

Use Delete to delete an item and remove the space it occupies. Access **Delete** from the **Edit** menu using the **Logic Editor** in either offline or online mode. Delete can also be accessed from the **Data Window**.

To delete:

1. Select the item or items you wish to delete.
2. Select **Delete** from the **Edit** menu. The **Delete** dialog box appears.

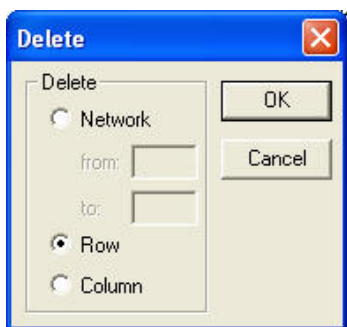

3. Click the items you want to delete.
4. Click **OK** or press [Enter].

The following table describes the deletion items.

Item	Function
Network	Deletes a network or a range of networks. To delete a range of networks, enter the number of the first network to delete in the From box. Then enter the number of last network to delete in the To box.
Row/Line	In Ladder, selecting a row deletes all instructions and branches from the row where the cursor is positioned. Logic below the deleted row(s) moves up. When box instructions prevent a deletion, an error message appears.
Column	Deletes instructions and branches from the column where the cursor is positioned. Logic to the right of the deleted column(s) moves left. When box instructions prevent a deletion, an error message appears.

Logic Editor - Online

Using **Delete** in the Logic Editor while online works the same as in offline mode. However, a row or column cannot be deleted unless it is empty.

Data Window

While working in the Data Window, you can use **Delete** to clear all rows or one row at a time. Delete is accessed through the **Edit** menu.

Insert

Use Insert to insert a selected object (network, instruction, row, or column) at the point of the current cursor position. Access Insert from the **Edit** menu using the **Logic Editor** in either offline or online mode.

To insert an object:

1. Select **Insert** from the **Edit** menu. The **Insert** dialog box appears.

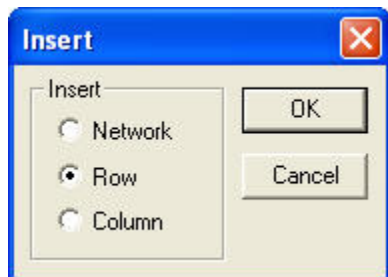

2. Click on the object you want to insert.
3. Click **OK** or press [Enter].

Logic Editor - Offline

Item	Function
Network	Adds a new network before the current network where the cursor is positioned.
Row/Line	Adds a new row is before the row where the cursor is positioned. If box instructions prevent insertion, an error message appears.
Column	Adds a new column before the column where the cursor is positioned. If box instructions prevent insertion, an error message appears.

Logic Editor - Online

Insert is accessed in the same manner online as offline. However, only a network or column can be inserted while working online.

Item	Function
Network	With the cursor positioned at a network, Insert places a new network before the current network.
Column	A new column is inserted before the column where the cursor is positioned. If box instructions prevent insertion, an error message appears.

Merge

The program merge allows a user to merge all or parts of a program into another program. Both programs must be loaded into WorkShop because the program being merged cannot be read from a disk file. The target program (the one receiving the data) must have its configuration setup complete, have no unverified edits, and be in offline. The source program is unchanged during the merge process.

The user starts by loading the source program into PLC WorkShop, then configuring the target program. Next, the Merge Program option is selected from the File menu. This brings up the Modicon Program Merge program dialog box. Selecting the merge button closes the Pick dialog box and brings up the Merge Program choice dialog box. This presents the user with the PLC type and configured quantities of the source and destination programs. In this dialog, the user can choose what parts of the program to merge. Since both programs are available to this dialog, specific errors are displayed if the user chooses to merge a part that cannot be merged without corrupting the target program. Finally, the user picks a name and directory of the Error text file and presses the start button.

A meter window is used to show progress of the merge process until it is complete. The final window shows the result window which displays the total errors and warnings found during the merge. The user can then examine the log file for information on improving or cross-checking the merge.

Merge Program Procedure

Merge can be used to copy a part of a program just like copy and paste. However, its main purpose is to support configuration changes that would clear the program or transfer logic from an older PLC to a newer one. The following is an example of how to merge an existing program to a new program.

1. If the source program has any loadables, they should be saved to individual *.DAT or *.EXE files using the Loadable dialog in the PLC configuration dialog. This must be done since merge does not copy loadable data to the target program.
2. A new program should be created for the PLC type wanted.
3. PLC configuration should be set for the values wanted. Once the merge begins, this cannot be changed.
4. Any loadable that was previously saved should be merged using the Loadable dialog.
5. Now the merge can begin. Load into offline the program you want to use as the source program (if it is not already loaded).
6. While in the source program, pick merge from the File menu. The Modicon Program Merge Pick Target dialog is displayed. Pick the Target program from the drop down list box. This program must be offline and have no edits. Press the merge button to continue.
7. The Merge Program Choice Dialog appears. As this dialog is displayed, both programs are examined and defaults are placed in the check boxes and ranges. Each section defaults are explained in the Choice dialog section.
8. The Error file text name must be entered before the actual merge can proceed. Once this is done, press the start button to start the merge.
9. Once the merge is complete, a dialog is displayed with the number of errors and warnings found during the merge.
10. Error text file: This file directs the user to any area that had trouble being merged. Each section is explained below what gets placed in the file.

Pick Destination Merge Program Dialog

The user should be in the source program to bring up this dialog from the File Menu. The source program cannot have any edits and must be an offline program. All offline programs that have no edits, except the source program, are placed in the drop down list box. The user can pick any one of these programs for the target of the merge.

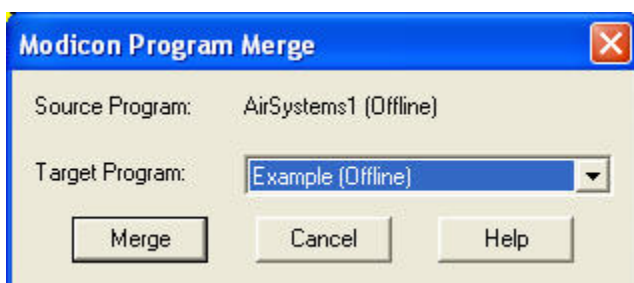

Cancel - Exits without changing the target program.

Help - Brings up help.

Merge - Closes this dialog and brings up the **Merge Program Choice** dialog.

Merge Program Choice Dialog

The Choice Dialog allows the user to choose which parts of the source program they want to copy to the target program. The top of the dialog displays the PLC Type, 0x, 1x, 3x and 4x register for each program. Each check box is explained below.

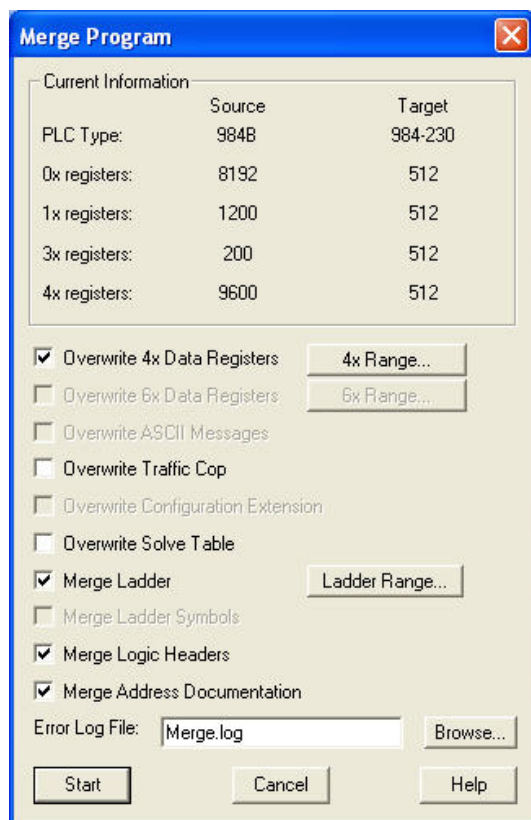

4x Range – Brings up 4x-range dialog.

6x Range – Brings up 6x-range dialog.

Ladder Range – Brings up the Ladder Range dialog.

Browse – Brings up the Common Open dialog.

Cancel – Exits without changing the target program.

Help – Brings up help.

Start – Begins the merge process that will change the target program.

Merge 4x Check Box

This check box is initially checked and the range is 400001 to 4x maximum. Merging of 4x data is destructive to the target program because all copied values overwrite current values in the range.

4x Range

This dialog allows the user to specify a range of 4x registers from the source program in the source group. The Target group box holds the first 4x register to be overwritten. This will continue for the length of registers specified in the source group.

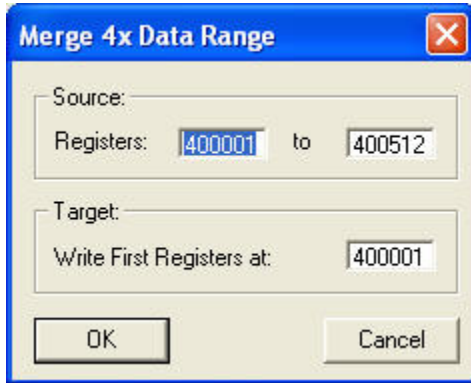

Merge 6x Check Box

This check box is initially unchecked and the range is 600000 to 6FXXXX where maximum file (F) and last file size (XXXX). The range can cross-file boundaries. Merging of 6x data is destructive to the target program because all copied values overwrite current values in the range.

6x Range

This dialog allows the user to specify a range of 6x registers from the source program in the source group. The Target group box holds the first 6x register to be overwritten. This will continue for the length of registers specified in the source group. The range does cross-file boundaries.

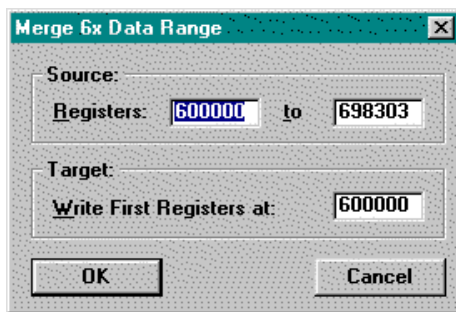

Merge ASCII message Check Box

The configuration of both programs is used to determine if the ASCII check box is checked or grayed. If the target program does not have any ASCII configured, then the checkbox is grayed. The merge of the ASCII message does not touch configuration in the target program, so the user must have it properly configured.

If the following is true, then the check box is checked:

1. The source Total Words Used must be \leq Words Available in target.
2. The Highest Message Used in source is \leq the target Total Messages.

If either of these is NOT true, then the box is unchecked. If the user tries to check the box, an error message is displayed: "ASCII Message cannot be merged, either, not enough words available in target, or not enough messages."

Merge of ASCII is destructive to the target because it overwrites existing messages if the message numbers are the same in the source. The merge copies all messages, at a specific message number, to the same number in the target.

Merge Traffic Cop Check Box

The type of Traffic cop in both programs determines if the check box is checked or unchecked. If source PLC and target PLC are the same type and basic form, the target TCOP size is large enough, and depending on the PLC if the drops number are the same in both Programs, then the check box can be checked.

The check box is unchecked if it is not possible to merge the Traffic Cop. If the user tries to check the box, one of three error messages is displayed

1. "Traffic Cops are not compatible, unable to merge to target."
2. "Source Traffic Cops size used is larger then target Traffic Cop size."
3. "The number of drops in source does not match drops in Target."

Merging of Traffic Cop is destructive to the target program; all existing drops are removed.

The merge is all or nothing. If there is a single error, the merge of TCOP is aborted. After the merge is started, checks are done. The following are the possible errors:

1. Too many modules in drop 1 of 480, 485, 485E (max 21 not 32).
2. Processor position in drop 1 not free.
3. Illegal address in module.

On an error, the merge continues but the TCOP is not merged, and the error that caused the abort is written to the Error Log Text File.

Merge Configuration Extension Check Box

The type of PLC and configuration extension size in both programs determines if the check box is checked or unchecked.

If the source PLC and target PLC are NOT the same type, or if the Source Extension words used is > the size of the Extension in the Target PLC, then the check box is unchecked. If the user tries to check the box, one of two error messages are displayed:

1. "Configuration Extensions are not compatible, unable to merge to target."
2. "Target Configuration Extension size is too small."

The merging of Configuration Extension is destructive to the target program because existing Extensions are removed.

Configured quantities are not checked on a merge and are the responsibility of the user to check. A warning is placed in the log file if the extension is merged:

"Warning: Merging of Configuration Extension may have included invalid registers."

Merge Solve Table Check Box

The type of Solve Table and number of drops and segments in both programs determines if the check box is checked or unchecked.

If source and target Solve Tables are NOT the same type, or the number of segments and drops are not the same, then the check box is unchecked. If the user tries to check the box, one of two error messages are displayed:

1. “Solve Tables are not compatible, unable to merge to target.”
2. “The number of Drops and/or Segments are different, unable to merge to target.”

Merging of Solve Table is destructive to the target program; the previous Solve Table is replaced.

Configured quantities are not checked on a merge and are the responsibility of the user to check. A warning is placed in the log file if the Solve Table is merged:

“Warning: Merging of Solve table may have included invalid 0x or 1x registers.”

Merge Ladder Check Box

This check box is initially checked and the default range is the minimum number of segments for both programs and maximum networks, for each segment, in the source program. The first network in the target program segment is defaulted. The Ladder Range dialog exists to change these defaults.

The Ladder merge is non-destructive; no existing ladder is deleted. Networks can only be added to existing segments. The first part of the ladder merge is for a DX instruction difference table to be written to the log file. Then the segments are examined in order, and the network ranges picked are copied to the target program. The following items are checked as the network is copied.

1. New rung fits into the new program memory.
2. Each instruction in the network is checked for validity. This includes valid instruction and valid addresses.
3. Coils for each instruction are checked so that they are not duplicated.

If the program runs out of memory, the merge stops. If a network is invalid or coil is duplicated, then the network is skipped and the log file is updated with:

“Error: Source Network xxxx in Segment xxxx did not merge.”

The specific error is then added to the error file. Merging of Ladder will invalidate the cross-reference.

Ladder Range

The Merge Ladder Range dialog has a list box which lists the networks within each segment from the source program that are merged into the targets segment at a starting network. A Line in the list box looks like this:

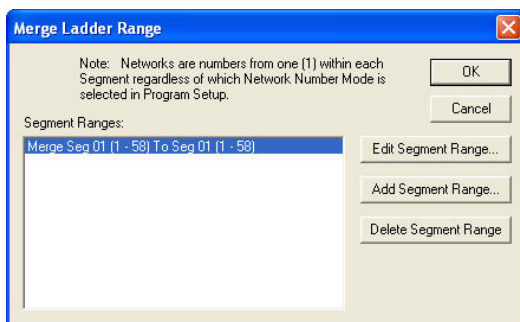

This implies that the source segment 1 networks 1 to 5 will be merged into the target at segment 1 network 1 to 5.

OK – Enters the new ranges in List box.

Cancel – Does not enter any changes to the range.

Edit Segment Range – Allows changing an exist range in the List box.

Add Segment Range – Allows adding a new segment range in the List box.

Delete Segment Range – Removes an existing highlighted segment range in the list box.

Merge Ladder Symbols

If the source program has graphical Symbols within it, this checkbox ensures that the symbols and library are merged with the target program. This creates a new library within the source program.

Error Checking on Edit or Add:

A segment number in the source can only be used once. Also, a segment number in the target can only be used once. The segment number cannot exceed the existing segment for the specific program.

Network number in the source cannot exceed existing networks. Network number in the target cannot exceed the maximum existing networks in segment plus 1 (i.e., if target has 4 networks, source network 1-5 can be copied to starting network 1 to 5.)

DX Table

The purpose of the DX difference table is to inform the user that some instructions may not be supported in the new PLC or that converted logic may be incorrect.

Each DX instruction is read out of the source program and checked with each in the target program.

If the DX is supported with same name and same opcode, then nothing is written to the log file.

If the DX is not supported (Name missing from target), then it is written to the log file: “XXXX instruction is not supported.” Any network with this instruction in it will not merge. But, if the Name is missing but the opcode is used by another instruction, the “XXXX instruction has been replaced by XXXX instruction” is written to the log file.

If the DX name is the same but opcode is different, then it is written to the log file: “XXXX instruction has different opcode.” The user must manually update any network with this instruction in it.

Merge Logic Headers Check Box

This check box is initially checked. Merging of header is destructive to the target program because all existing headers are overwritten. Only Segment headers for Segments that are merged get copied to the target program according to the ladder range. Also, only network headers for copied networks are merged.

Merge Address Documentation Check Box

This check box is initially checked. Merging of Address Documentation is destructive to the target program because all duplicate addresses in target are overwritten. All addresses in the source that have documentation are merged to the target program.

Error Log Text File

The Error Log file name and path must be entered before starting the merge. The user can type the name and path in the edit box or use the browse button. The browse button opens up the Windows common open dialog.

Using WorkShop with FTVersionTrak

PLC WorkShop integrates seamlessly with FTVersionTrak, FasTrak's powerful file change management software.

FTVersionTrak safeguards your valuable work in progress, preserves previous versions of files, and stores files in a safe place. If for some reason you lose a file or it becomes corrupt, you can retrieve a previous version of the file from the FTVersionTrak repository. FTVersionTrak also details version histories, allows electronic signatures, organizes files, and more.

You can be sure no one else is editing a file when you store it in FTVersionTrak because only one person at a time can check out the file, making it read-only to other users. You can view checked out copies of files by getting them from FTVersionTrak.

FTVersionTrak recognizes whether or not a file is being edited and by whom, so team members can work on a program concurrently without overwriting each others' work. As long as each programmer is using the same FTVersionTrak database, all team members can see each other's changes in a program.



Programmers in a single-user environment can also benefit from using FTVersionTrak. Using FTVersionTrak is beneficial for single users who want to centralize their programs onto a secure server. FTVersionTrak also provides revision tracking and file state transitioning throughout the life of the program, which is beneficial to both single-user and team programming environments.

If you are not currently using FTVersionTrak to safeguard your PLC programs, visit **www.fast-soft.com** to download a demo or contact Sales at **sales@fast-soft.com** for more information.

Getting Started with FTVersionTrak

If you are using FTVersionTrak to protect and manage your WorkShop files for the first time, follow these steps to begin.

To get started using FTVersionTrak with WorkShop:

1. Check with your network or systems administrator to address issues such as access rights, user accounts, etc. If you are the network or systems administrator, review the ***Administrator Guide*** in the FTVersionTrak manual.
2. One user adds an existing program (or creates a new program and adds it) to the FTVersionTrak repository by clicking the  icon on the FTVersionTrak toolbar.
3. Other users get the file from the repository by launching FTVersionTrak, highlighting the file, and either selecting the **Version \ Get Latest Version** or clicking the  toolbar icon.
4. If multiple programmers will be working on the same programs at the same time, see *Tips and Strategies for Team Programming*. These strategies will help everyone involved use FTVersionTrak in the same way.
5. Begin using WorkShop like you normally would, by opening, editing, saving, and closing the program files. FTVersionTrak's seamless integration automates the version control process.
6. Read *FAQs about FTVersionTrak* and *Using FTVersionTrak in WorkShop* for more information. Also see *Operation Modes in FTVersionTrak*.

Using FTVersionTrak in WorkShop

Certain aspects of the WorkShop environment are different when your WorkShop program is being protected by FTVersionTrak. Most differences occur automatically when opening and closing WorkShop files. All other version control features can be accessed using the FTVersionTrak toolbar.

You can change the way FTVersionTrak behaves within WorkShop by selecting the **Options \ Application Setup** WorkShop menu item. The **Application Setup** dialog lists options specifically for FTVersionTrak in the **FTVersionTrak Options** group box.

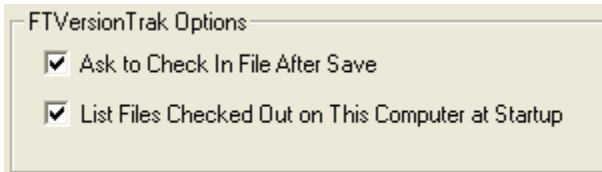

Select the **Ask to Check In File After Save** check box to prompt the user to check in a program whenever the file is saved. See *Saving WorkShop Files* for more information.











Select the **List Files Checked Out on This Computer at Startup** check box to display a list of files checked out whenever you launch WorkShop.

FTVersionTrak Toolbar

The FTVersionTrak toolbar displays a row of icons that represent version control options available in WorkShop. View the FTVersionTrak toolbar by selecting the **View \ Toolbars \ FTVersionTrak Toolbar** menu item.



Icon	Function
	Connect to FTVersionTrak repository and add active program
	Get a version of active program file and place it into your working directory
	Check out active program
	Check in active program
	Undo checkout of active program
	Compare working copy of active program to version in repository
	View version history of active program
	Electronically sign active program
	Launch FTVersionTrak

Adding Files to the FTVersionTrak Repository

Before FTVersionTrak can begin securing your program files, they must be added to the FTVersionTrak repository. The repository is a secure, compressed database that exists apart from your local file system. This database keeps track of any changes made to the files added to it, as well as securing them from accidental or unauthorized deletion or removal.

To add a WorkShop file to the FTVersionTrak repository:

1. **Open** the program file in WorkShop.
2. Click the  icon on the FTVersionTrak toolbar. The **Bind File to Repository** dialog appears.

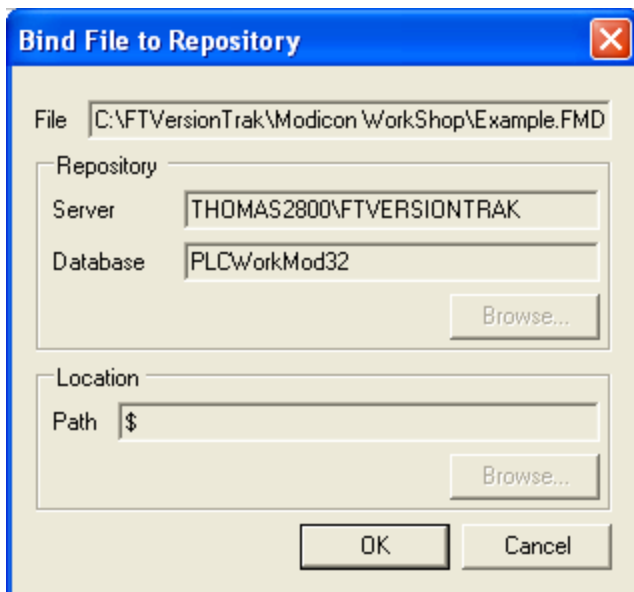

3. Click the **Browse** button in the **Repository** group box. The **Browse for Repository** dialog appears.

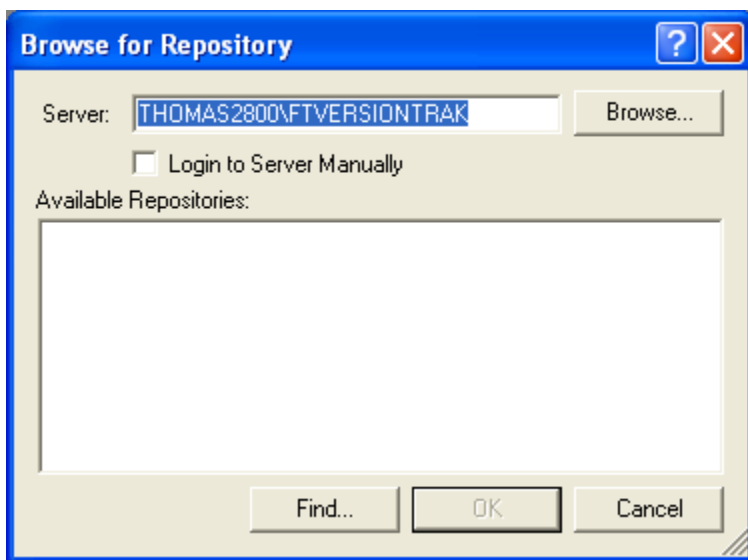

4. If an FTVersionTrak database exists on the local machine, it appears in the **Server** text box. If this is the database you would like to use, skip to Step 6. If no database exists, or to select another database, click the **Browse** button. The **Browse for Server** dialog appears.

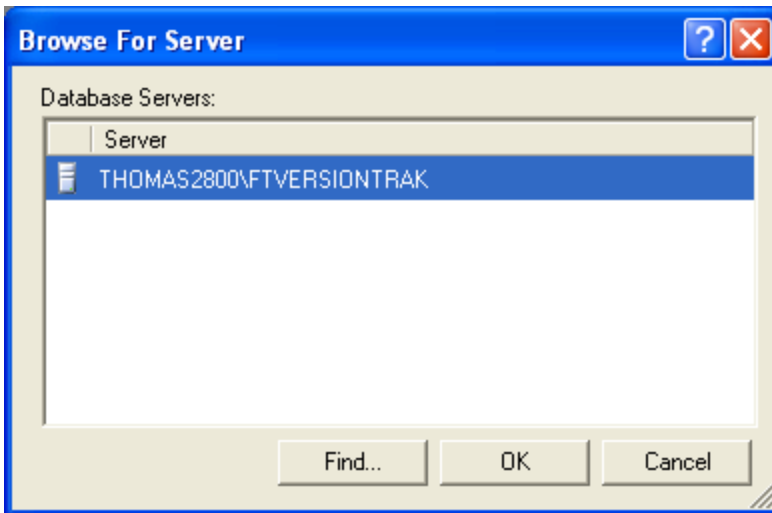

5. Click the **Find** button to search for all available database servers. Select the desired database from the list and click **OK** to return to the **Browse for Repository** dialog. If you still cannot find the database you are looking for, see you system administrator or consult the FTVersionTrak manual.
6. Select the **Login to Server Manually** check box to force a manual login to the server. Use this option if a different user usually logs in automatically and the login needs to be changed.
7. Select the repository you want to add the file to from the list of **Available Repositories** and click **OK**. If the desired repository does not appear in the list, click the **Find** button to search for all repositories available in the selected database. If you still cannot find the repository you are looking for, see your system administrator or consult the FTVersionTrak manual.
8. After selecting the repository, the **Repository Login** dialog appears.

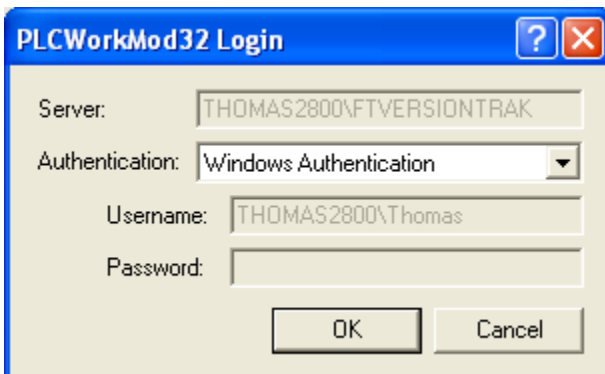

Select the preferred authentication type from the **Authentication** combo box:

- **Windows Authentication** - This option utilizes the local Microsoft Windows user accounts to log on to the server. If this option is selected, the user currently logged in to Windows will appear in the Username text box. No password is necessary, and the login information cannot be edited.
- **SQL Authentication** - This option uses the login information located on the server itself. Selecting this option will prompt for both a username and password. See your system administrator for more information.

Click **OK** to continue.

9. Click the **Browse** button in the **Location** group box. The **Select Repository Folder** dialog appears.

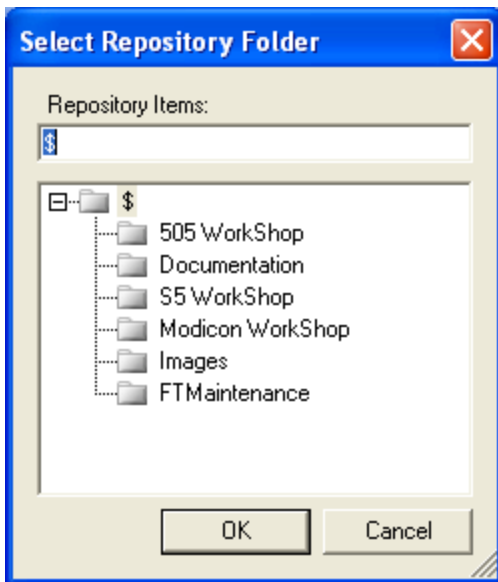

10. Select the repository folder you would like to add the program file to and click **OK** to return to the **Add File to Repository** dialog.
11. Click **OK** in the **Add File to Repository** dialog. The file is added to FTVersionTrak.

Getting Versions of a File

The **Get** action retrieves a version of the active program from the repository and places it in your working directory as a read-only copy to review or check out.

To get a version of the active WorkShop program:

1. Click the  icon on the FTVersionTrak toolbar. The **Get** dialog appears.

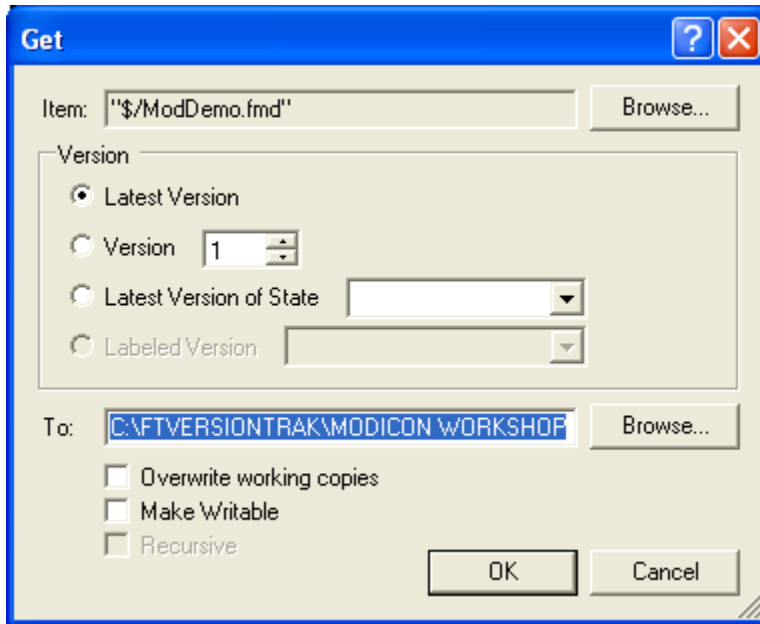

2. Select the options of the version you would like to get in the **Version** group box:
 - Selecting the **Latest Version** radio button places the latest version of the file into your working directory.
 - Selecting the **Version** radio button allows you to choose the version you would like to get.
 - Selecting the **Latest Version of State** radio button allows you to choose a version with a particular repository file state.
 - Selecting the **Labeled Version** radio button allows you to choose a version with a particular label.
2. In the **To:** text box, enter the directory in which to place the working copy or click **Browse** to locate the desired directory. If a working directory has been set, it appears in the text box. If a working directory has not been set, the text box appears as blank.
3. Select the **Overwrite working copies** check box to automatically overwrite any files located within the directory assigned in the **To:** text box with the **Get** target files of the same name.
4. Select the **Make Writable** check box to remove the read-only status from the program file.

NOTE: Making working copies writeable is not recommended for files you wish to keep under version control. Do not select this option if you plan on checking out and editing the file.

5. Click **OK** when finished. A version of the file is placed in the selected directory.

NOTE: If the path selected in the **To:** text box is the same as the path of the active program file, the active file will be overwritten even if the **Overwrite working copies** check box is not selected. If you proceed to overwrite the active program file, the program will exit and any existing changes will be lost. You must open the program again to continue.

Checking Out Files

To make changes to your WorkShop program using FTVersionTrak, it must first be checked out. Checking out a file places a writeable copy of the file within the user's working directory. If the file is already present in the working directory (following a Get action, for example) then FTVersionTrak removes the read-only status on the file while it is checked out.

1. Click the  icon on the FTVersionTrak toolbar. The **Check Out** dialog appears.

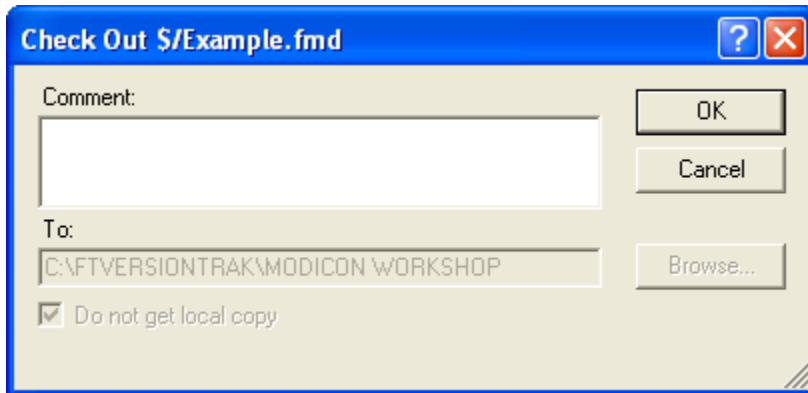

2. In the **To:** text box, enter the directory in which to place the working copy or click **Browse** to locate the desired directory. If a working directory has been set, it appears in the text box. If a working directory has not been set, the text box appears as blank.
3. Select the **Do not get local copy** check box if you do not wish to get the version of the repository file while checking the file out.

NOTE: Using the **Do not get local copy** option only checks out the file. This is helpful if your working copy is different than the latest version within FTVersionTrak.

4. If desired, enter a comment about the check out within the **Comment** text box. This comment may be edited when the file or folder is checked in. Click **OK** when finished.

After checking out a file or folder, the following options are available:

- **Check In** the file or folder to write any edits to FTVersionTrak and create a new version.
- **Undo the Check Out** to cancel any changes made to the file or folder.

Checking In Files

Check in the program file to write changes to the master copy located in the FTVersionTrak repository. After you check the file in, other users will be able to Get the modified file, view the changes you have made to the file, and check out the file to work on it as well.

To check in the active WorkShop file:

1. Click the  icon on the FTVersionTrak toolbar. The **Check In** dialog appears.

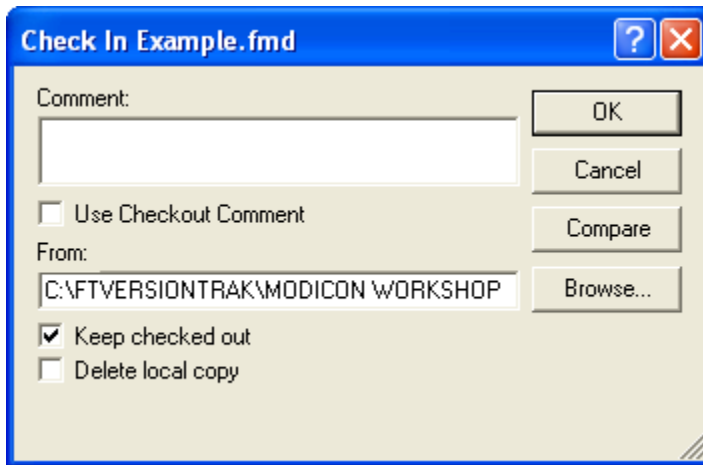

2. In the **Comment** text box, type a comment for the check in (optional). If a comment was entered during checkout, it will appear by default in the text box. Select the **Use Checkout Comment** check box to use this comment.
3. The **From:** text box will display the local path that the new version will be written from (usually the working directory). Click **Browse** to navigate to a different directory.
4. Select the **Keep checked out** check box to write any changes to the repository but keep the program checked out to you.
5. Select the **Delete local copy** check box to remove the working copy on your local system after the check in.
6. Click the **Compare** button to compare the difference between the version being checked in and another version in the repository.
7. Click **OK** when finished to check in the items.

Undoing a Check Out

Undo the check out if you decide not to save any changes to the repository or create a new version of the WorkShop program. Undoing a checkout leaves the file in the state it was in before you checked it out. No new version is created, and no record of the checkout will be left.

To undo a check out of the active WorkShop program:

1. Click the  icon in the FTVersionTrak toolbar. The **Undo Check Out** dialog appears.

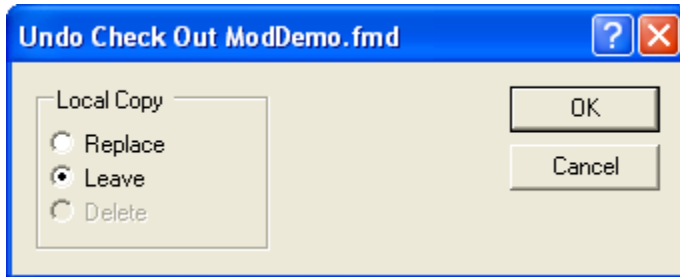

2. Select a **Local Copy** option:
 - Select **Replace** to replace the local copy of the checked out file with the latest version within the repository.
 - Select **Leave** to leave the existing copy of the checked out file on your local system.
 - Select **Delete** to delete the local copy from the location of the check out. If the file was checked out to a location other than the working directory, the location indicated at check out will be deleted and any other copies will be retained.
3. Click **OK** when finished to return to the main window.

Comparing WorkShop Files

One of the most useful features of FTVersionTrak is the ability to compare the contents of two WorkShop files to each other. Within WorkShop, you may compare two different versions of the same WorkShop program to each other, or compare a version in the FTVersionTrak repository to the working copy on your local hard drive.

To compare the working copy of the active WorkShop program to the latest version in the repository:

1. Click the  icon on the FTVersionTrak toolbar. The **Compare Files** dialog appears.

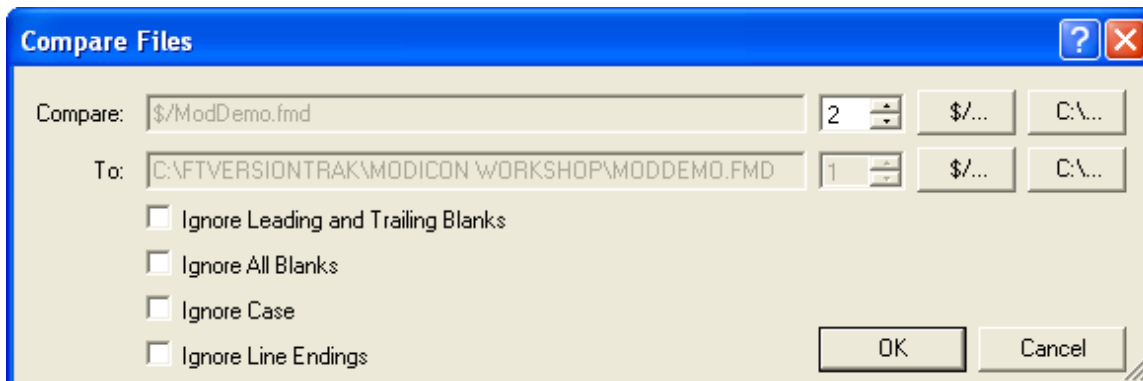

2. Click **OK** to view the file compare results. See the FTVersionTrak documentation for more information on file compare results.

To compare the difference between two version of the active WorkShop program:

1. Click the  icon on the FTVersionTrak toolbar. The **History** dialog appears.

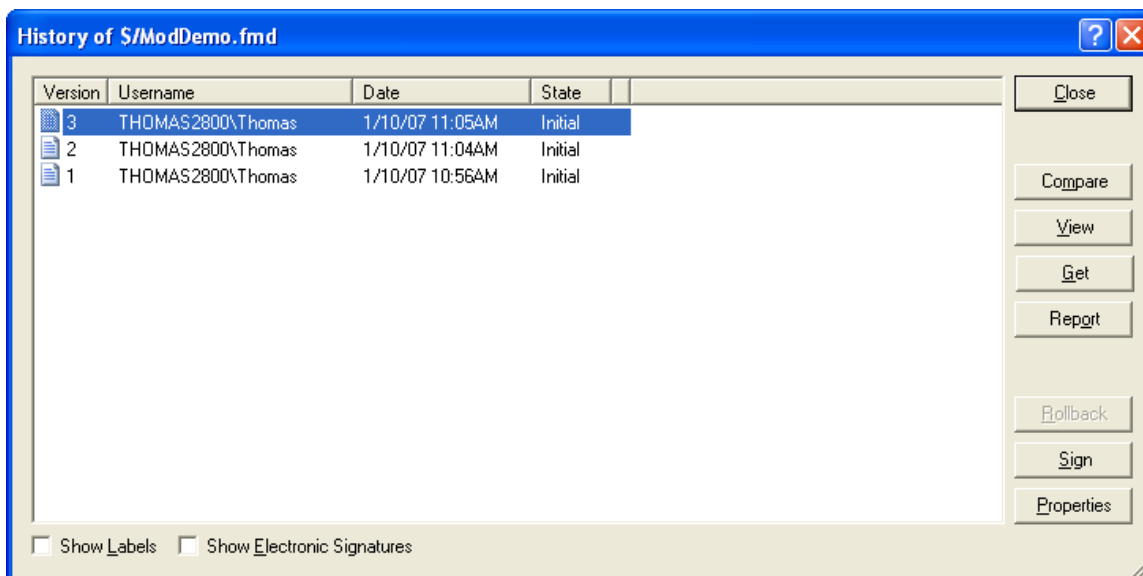

2. Highlight the first version of the file you would like to compare. Hold down the **[Ctrl]** key and select the second version of the file you would like to compare. Click the **Compare** button. The **Compare Files** dialog appears.

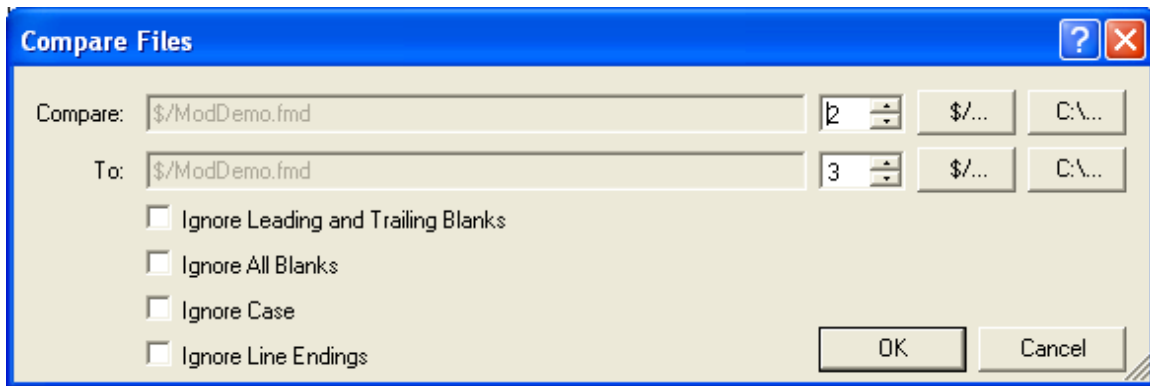

- The check box options apply only to text file comparison and can be ignored when comparing WorkShop files.
3. Click **OK** to view the file compare results. See the FTVersionTrak documentation for more information on file compare results.

NOTE: Clicking the **Compare** button without selecting more than one version will compare the selected version to the working copy. Clicking the **Compare** button without selecting any version will compare the latest version to the working copy.

Viewing File History

Each WorkShop file that is managed by FTVersionTrak is given its own history. As you check out, edit, and check in your programs, the history is updated to reflect these changes. Viewing history is the best way to get a clear picture of the changes a program has gone through.

To view the active WorkShop program's version history:

1. Click the  icon in the FTVersionTrak toolbar. The **History** dialog appears.

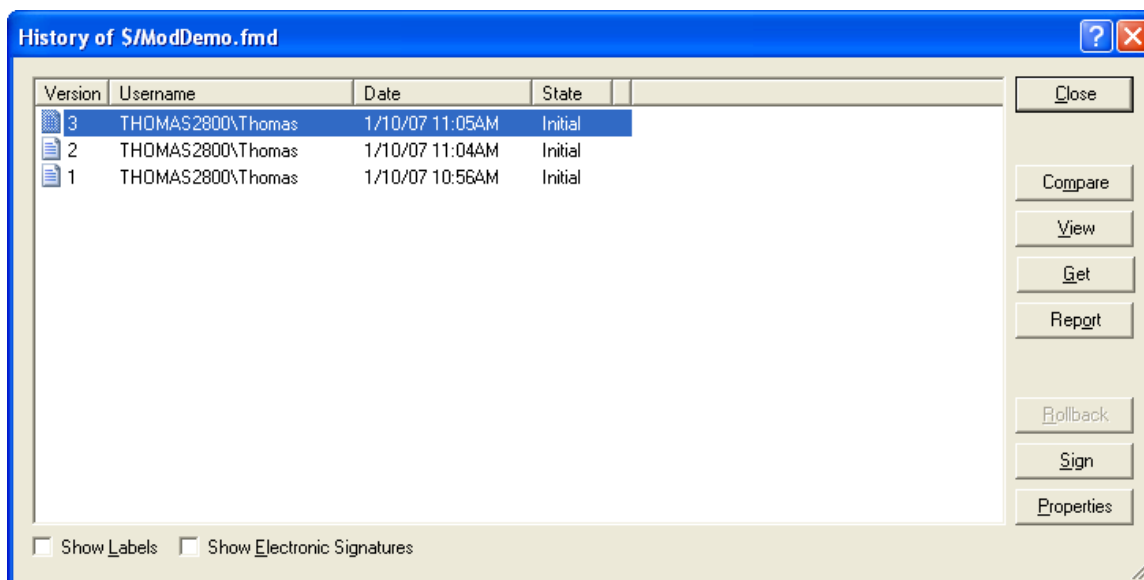

2. The **History** dialog displays all the version information of the selected file. Each version displayed in the **History** dialog contains the following information:
 - **Version** - The version number of the listed version.
 - **Username** - The name of the user that created the listed version.
 - **Date** - The date and time the listed version was added to the repository.
 - **State** - The version state of the file when it was added to the repository.
 - **Comment** - The contents of the optional comment created when the file was checked in.
3. The following two optional version histories may be viewed by selecting the appropriate check boxes at the bottom of the **History** dialog:
 - **Show Labels** - Select this option to display any associated labels with the repository file. Each label will appear as a separate version of the file, with the tag "Label" substituted for the version number.
 - **Show Electronic Signatures** - Select this option to display any associated electronic signatures with the repository file. Each signature will appear as a separate version of the file, with the tag "Signature" substituted for the version number.
4. The buttons on the right side of the History dialog are used to manage a file's history:
 - **Close** - Closes the **History** dialog and returns to the main window.

- **Compare** - Selecting a version and clicking the **Compare** button will compare the selected version with the copy in the user's working directory. Selecting two versions and clicking the **Compare** button will compare the two versions to each other.
- **View** - Launches the application associated with the selected version, and opens the version of the file within the application as a read-only document.
- **Get** - Retrieves the selected version of the file to the user's local working directory.
- **Report** - Generates a history report of the selected repository file.
- **Rollback** - Reverts the most recent version of the repository file to the selected version. Rollback is only available if the file has more than one version, and can only be selected when a version other than the latest version is selected.
- **Sign** - Electronically signs the selected version of the file, and allows the option to change the version state.
- **Properties** - View the properties of the selected version, and allows the option to change the version comment.

Electronically Signing WorkShop Files

Electronic signatures can be used as an approval method to verify that a certain user has seen a selected version of a repository file, and can also be used to advance the version state of the repository file. FTVersionTrak's electronic signatures are approved by portions of the 21 CFR Part 11 Standard.

To electronically sign the active WorkShop program:

1. Click the  icon on the FTVersionTrak toolbar. The **Sign Document** dialog appears.

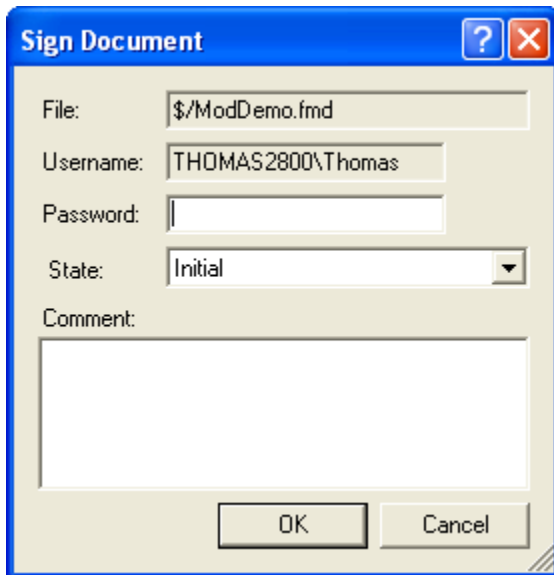

The image shows a Windows-style dialog box titled "Sign Document". It has a blue title bar with a question mark icon and a close button. The dialog contains the following fields and controls:

- File:** A text box containing "\$/ModDemo.fmd".
- Username:** A text box containing "THOMAS2800\Thomas".
- Password:** An empty text box.
- State:** A dropdown menu with "Initial" selected.
- Comment:** A large empty text area.
- Buttons:** "OK" and "Cancel" buttons at the bottom.

2. The **File** and **Username** text boxes are filled with the selected file and current user, respectively. Type the current user's password in the **Password** text box.
3. Select the current version state of the file from the **State** combo box and type any comments in the **Comment** text box (optional).
4. Click **OK** when finished to return to the main window.

Launching FTVersionTrak

Some version control tasks cannot be performed using the FTVersionTrak toolbar. These tasks may include:

- Getting repository files for the first time
- Renaming repository files
- Deleting repository files
- Moving and sharing repository files
- Setting up server and repository security
- Setting up and viewing audit logs
- Scheduling automated tasks

You must perform these types of functions in the stand-alone FTVersionTrak application.

To launch FTVersionTrak from within WorkShop:

1. Click the  icon on the FTVersionTrak toolbar. The FTVersionTrak application appears.

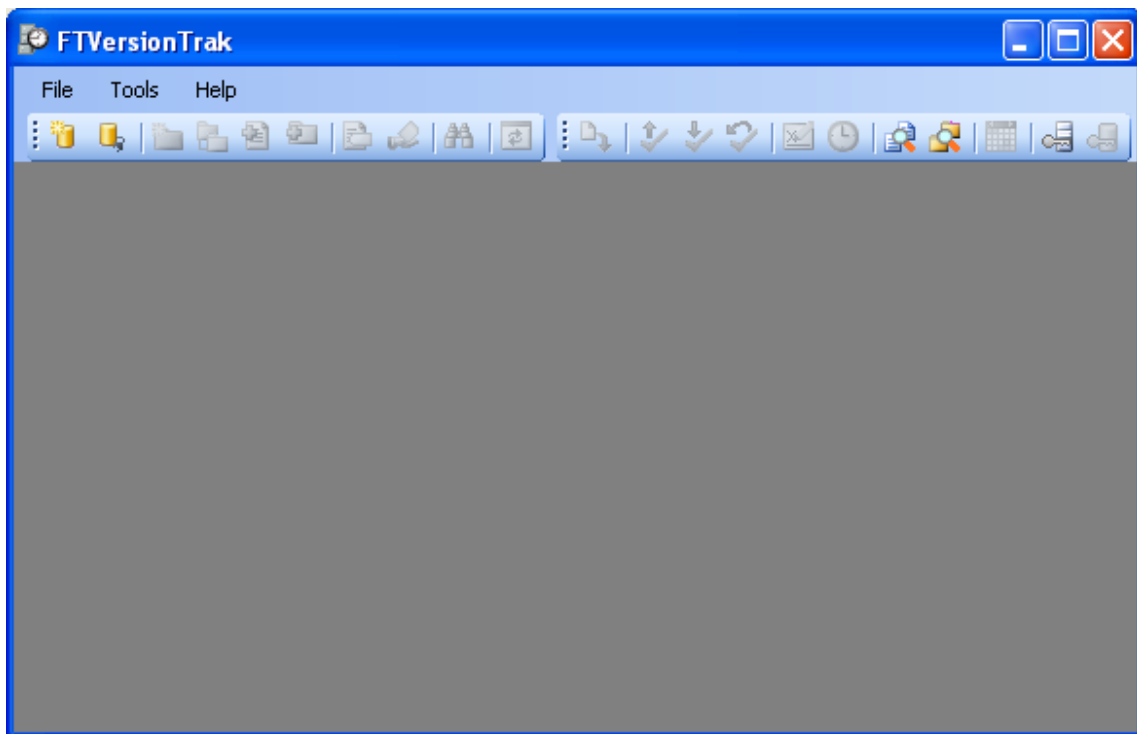

2. Connect to an FTVersionTrak repository by selecting the **File \ Connect to Repository** menu item or by clicking the  toolbar icon.
3. See the FTVersionTrak documentation for more information about FTVersionTrak's advanced features.

Opening WorkShop Files

Once a WorkShop file has been added to the FTVersionTrak repository and the latest version placed in your working directory, FTVersionTrak's seamless integration automates the version control process. Follow this simple procedure when opening WorkShop files protected by FTVersionTrak for best results:

1. After launching WorkShop, open the program by selecting the **File \ Open** menu item or by clicking the  toolbar icon. The **Open Program** dialog appears.

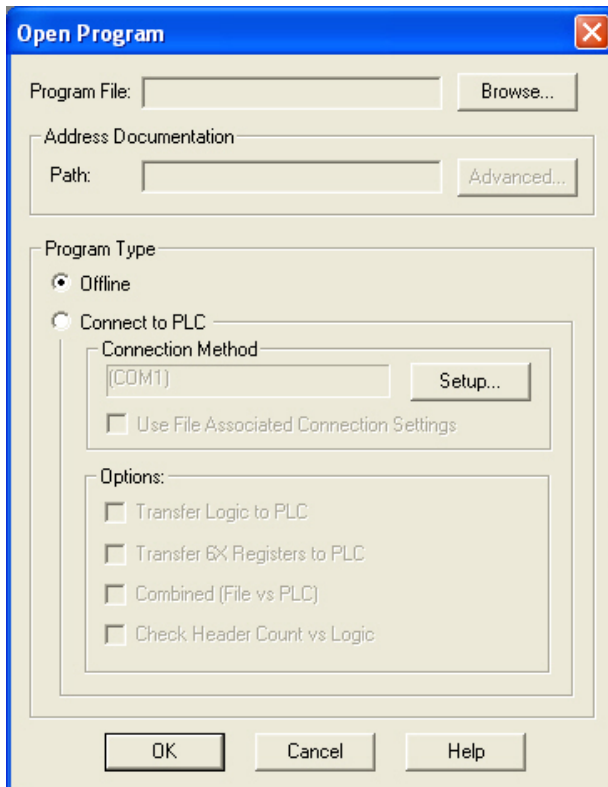

2. Click the **Browse** button and browse for the file. The file should be located in the directory specified in the **get** operation. Select the file and click **Open**. Click **OK** in the **Open Program** dialog. A repository login dialog appears.

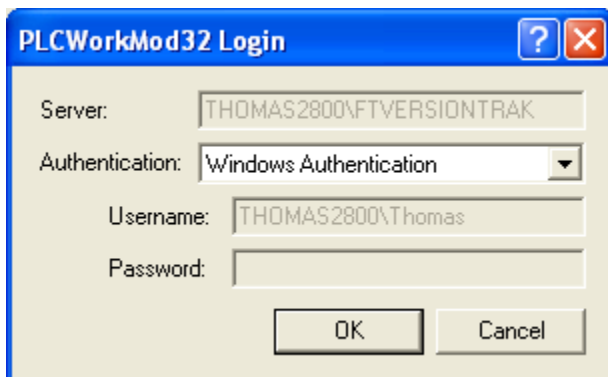

3. Enter your login information (the administrator will provide you with this information, if needed) and click **OK**.

4. FTVersionTrak compares your version of the program with the version stored in the repository. If a newer version of the program is available, a message appears, allowing you to get the latest version.

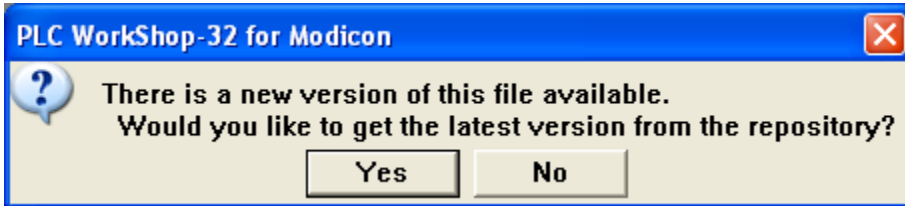

Click **Yes** to get the latest version. Click **No** to open the older version of the program.

5. FTVersionTrak then verifies the check out status of the file. If the file is checked out to you, it opens normally. If not, a message appears, allowing you to check out the file.

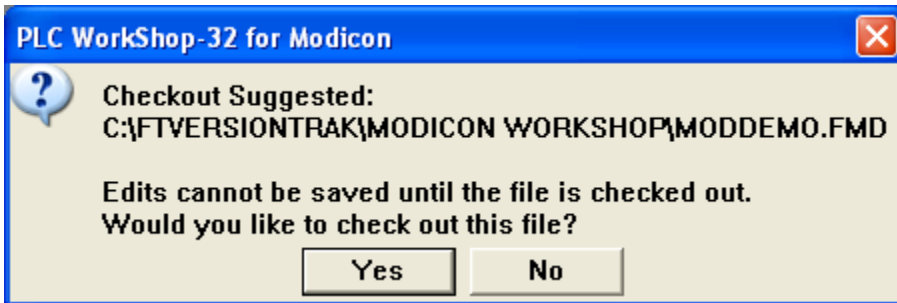

Click **Yes** to check out the file. Click **No** to open the file without checking it out. The program opens in WorkShop.

NOTE: If the program is already checked out by another user, FTVersionTrak will prevent you from checking out and editing the program. The program will open in a read-only state and changes will not be saved.

6. After the program opens, the FTVersionTrak toolbar becomes active. The actions available using the FTVersionTrak toolbar pertain to the active program.

Saving WorkShop Files

Edits to WorkShop files protected by FTVersionTrak are not complete until they have been saved and checked in. WorkShop automates this process to prevent accidental loss of changes to the program. The process below illustrates the various scenarios a user encounters when attempting to save a WorkShop file protected by FTVersionTrak.

Saving a WorkShop File That Has Not Been Checked Out

If you attempt to save a file that is tracked by FTVersionTrak, but not checked out, then you will be prompted to check out the file.

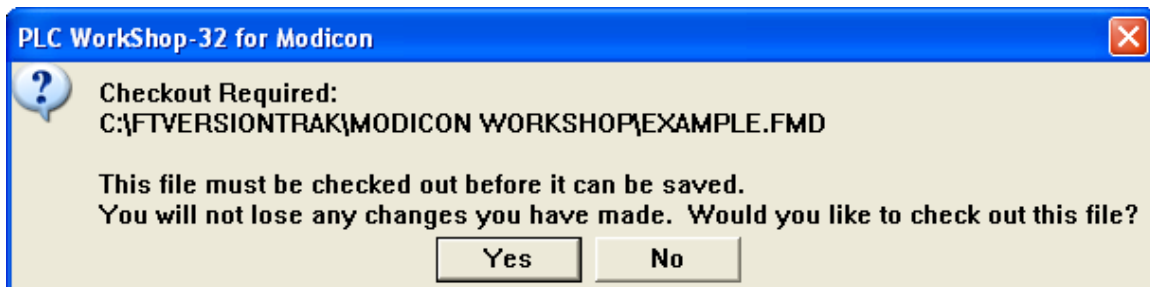

Clicking **Yes** displays the **Check Out** dialog. After the file is checked out, WorkShop saves the file.

NOTE: Depending on the **FTVersionTrak Options** set in WorkShop, available by selecting the **Options \ Application Setup** WorkShop menu item, you may be prompted to check in the file after it has been saved. Otherwise, you can check in the file by clicking the  icon in the FTVersionTrak toolbar.

If you click **No**, the **Save As** dialog appears. If the file is not checked out, you must save the file with a different filename to keep any changes made to the file.

Saving a WorkShop File That is Currently Checked Out

When you choose to save a program that is checked out to you, WorkShop can also check in the file for you automatically. Selecting the **Options \ Application Setup** menu item in WorkShop displays the **FTVersionTrak Options** available in WorkShop. Selecting the **Ask to Check In File After Save** check box displays the following message after each save:

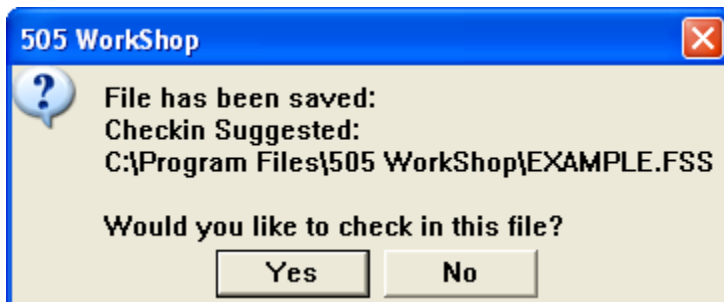

Clicking **Yes** displays the **Check In** dialog. After the file is checked in, WorkShop keeps the file checked out to you so that you may continue editing the program. Clicking **No** saves the working copy on your computer but does not write any changes to the FTVersionTrak repository. The file can be checked in manually by clicking the  icon on the FTVersionTrak toolbar.

Closing WorkShop Files

The procedure to close a WorkShop file is slightly different when the file is protected by FTVersionTrak. Depending on the file's status, FTVersionTrak offers a number of different options to the user to prevent the loss of data.

Closing Programs that are Checked Out

If the program file being closed is checked out to the current user, FTVersionTrak displays a prompt suggesting the file be checked in.

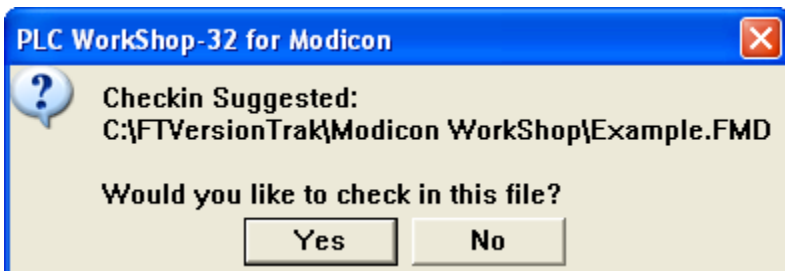

Click **Yes** to display the **Check In** dialog. After the file is checked in, the file closes normally. Click **No** to close the file, leaving it checked out.

NOTE: If the file contains edits that have not been saved, WorkShop will prompt the user to save file before continuing.

Closing Programs that are Checked In

If a program file being closed has been checked in and no edits remain pending, the file closes normally. However, if the file being closed is checked in (or has not yet been checked out) *and* edits have been made to the program that have not yet been saved, WorkShop will not immediately close the program.

WorkShop first prompts the user to save the file.

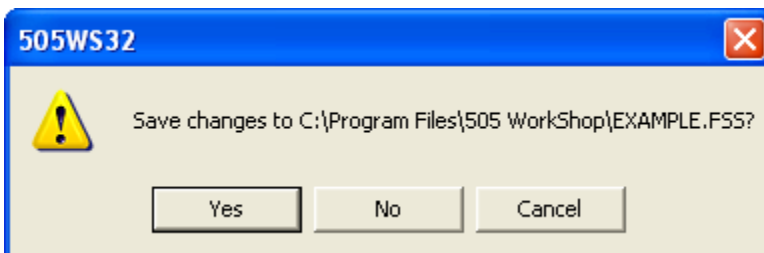

Click **No** to lose any unsaved changes and close the program. Click **Cancel** to cancel the save and keep the program open. Click **Yes** to save the file. WorkShop then prompts the user to check out the file.

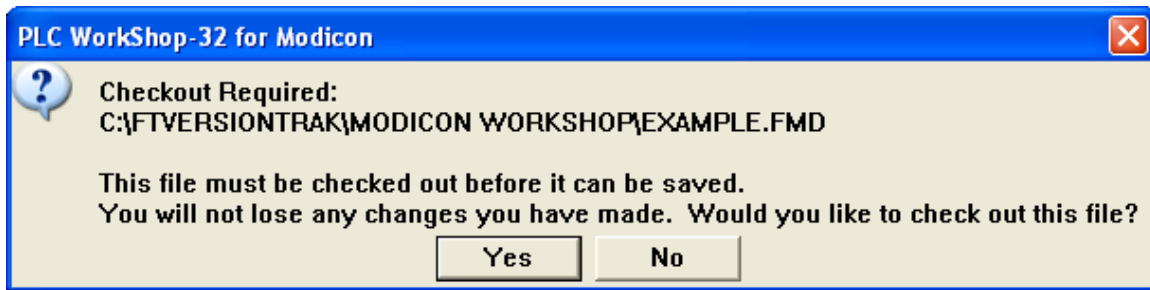

Click **No** to display the **Save As** dialog and save the file to another file name. Click **Yes** to display the **Check Out** dialog. Once the file has been checked out, Workshop prompts the user to check the file back in to the repository.

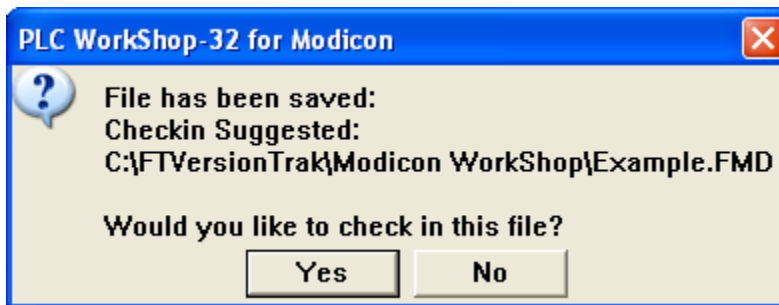

Click **No** to close the program without writing any changes to the repository. The file is still checked out to the user. Click **Yes** to write changes to the repository and close the program.

Operation Modes in FTVersionTrak

There are three distinct modes in which WorkShop can operate in regards to the FTVersionTrak functionality.

- **Not Tracked** – The file is not tracked by an FTVersionTrak repository.
- **Connected** – The file is tracked by an FTVersionTrak repository, and a connection to the repository is maintained by WorkShop.
- **Disconnected** – The file is tracked by an FTVersionTrak repository, but the connection is unavailable.

Following is a table that lists the available functions in the FTVersionTrak toolbar based on the operation mode of an active WorkShop file.

Operation	Not Tracked	Connected	Disconnected
Add to Repository	✓	--	--
Get Latest Version	--	✓	--
Check Out File	--	✓	✓ *
Check In File	--	✓	--
Undo Check Out	--	✓	--
Compare Files	✓	✓	✓
View History	--	✓	--
Electronically Sign	--	✓	--
Launch FTVersionTrak	✓	✓	✓

*Disconnected files can still be checked out to a user and edited even if a connection to the repository cannot be made. As long as the file was checked out by the user at a time when the user could connect to the repository, the file remains checked out to the user in disconnected mode. The file can be edited as if it were checked out, and can be checked in once a connection to the repository can be established.

FAQs about FTVersionTrak

What do I need to do to get started?

See *Getting Started with FTVersionTrak* for more information.

How does FTVersionTrak's version control work?

FTVersionTrak integrates seamlessly with WorkShop to track who is editing program files. When you want to work on a program (and another user isn't working on it), the program file is checked out from FTVersionTrak. You can also simply view programs in WorkShop without checking them out and get the latest changes from other users.

When you are done working on a program, you can check the file into FTVersionTrak manually or allow WorkShop to check in the program file when you close the program. Once your changes are checked in to FTVersionTrak, other users can get or check out the file and access your changes.

What can you do with programs under version control?

- Check out and edit program files without worrying about concurrent or overwritten changes.
- View the latest version of a program file while another user has it checked out.
- Get the latest changes to program files made by other users after they check in their files.
- Set version control options from within WorkShop and perform other version control tasks, such as viewing version history. (Performing version control tasks on your programs outside of WorkShop is possible but not recommended.)
- View the version control status of any program file, such as whether the file is checked out.

How do I use FTVersionTrak with multiple programmers working on the same program?

See *Tips and Strategies for Team Programming* for more information.

Can I use FTVersionTrak for single-user programs?

Yes. We recommend that single-user programs utilize FTVersionTrak's version control features even if they are not programming in a team environment. Using FTVersionTrak is beneficial for single users who want to centralize their programs onto a secure server. FTVersionTrak also provides revision tracking and file state transitioning throughout the life of the program, which is beneficial to both single-user and team programming environments.

Where can I set options for how FTVersionTrak works with WorkShop?

Select the **Options \ Application Setup** menu item in WorkShop to view the available options for changing the way FTVersionTrak behaves in WorkShop.

Do I ever need to open the FTVersionTrak application outside of WorkShop?

Yes, if you are using FTVersionTrak for the first time and need to Get the latest version of a WorkShop file from the FTVersionTrak repository. Also, to set up security, rights, and audit logs, you or your administrator need to do so from within the FTVersionTrak application (see the FTVersionTrak manual for more information). You can launch FTVersionTrak from within WorkShop by clicking the  icon in the FTVersionTrak toolbar.

Do I need to check out the program file to open the program?

There is no need to check out the file to simply view the program in WorkShop. However, the program file must be checked out to you if you plan on making any changes to the program.

How do I make sure I'm working on the latest version of a program?

Once the file has been checked in, you can get the latest version of a program when you open the program in WorkShop. You can also get the latest version of any specific program manually by clicking the  icon in the FTVersionTrak toolbar.

Tips and Strategies for Team Programming

When working in a team environment, creating a strategy that every team member is comfortable with is necessary to produce the most effective results. For successful team programming, use these example strategies along with the steps outlined in *Getting Started with FTVersionTrak* to develop your own team's version control strategies. Advantages and disadvantages of each strategy are given. Use some or all of these strategies together, along with your own, to achieve your team's goals.

- **Create and manage user accounts, access rights and repository security.** A system administrator or team manager can implement this strategy to prevent access conflicts and overwritten changes. This strategy takes advantage of the multiple levels of security FTVersionTrak has to offer.
- **Create repositories for specific users.** This strategy assures consistent usage and access among team members. The advantage of this strategy is that it is clear which files each team member is responsible for. Team managers can oversee the changes made by each user by accessing that user's repository.
- **Develop a task checklist.** Create a daily, weekly, or monthly task list that outlines specific version control tasks to be accomplished, such as checking in files, getting the latest version, and electronically signing documents, as well as standardizing steps for audits and reviews of changes made. The advantage of this strategy is that all team members will have a good idea of what kinds of changes are being made, so it is less likely that undesired changes will occur.
- **Keep critical programs checked out.** Keeping a file checked out prevents all other users from being able to make changes to the file. Use this feature to your advantage with your most sensitive programs by keeping them checked out to a privileged account or user. Any necessary changes must be made by that account, and can be written to the FTVersionTrak database without checking the file back in. Other users can view the latest changes at any time but are unable to make changes themselves.

4 - PLC WorkShop Setup

Overview

This chapter covers:

Program Setup	Customize the way PLC WorkShop handles a PLC program
Application Setup	Customize several features of PLC WorkShop that apply regardless of the PLC program
Communications Setup	Tell PLC WorkShop how the computer is connected to the PLC
Printer Setup	Select and configure the printer
Page Setup	Configure the layout of each page of a report
Fast PLC Setup	Set up communication parameters for the Fast PLC Connection function

Program Setup

Program Setup reveals different sets of tabs governing a project's layout and appearance.

These settings are saved with the program; thus, each time the program is opened, preferences do not need to be reset.

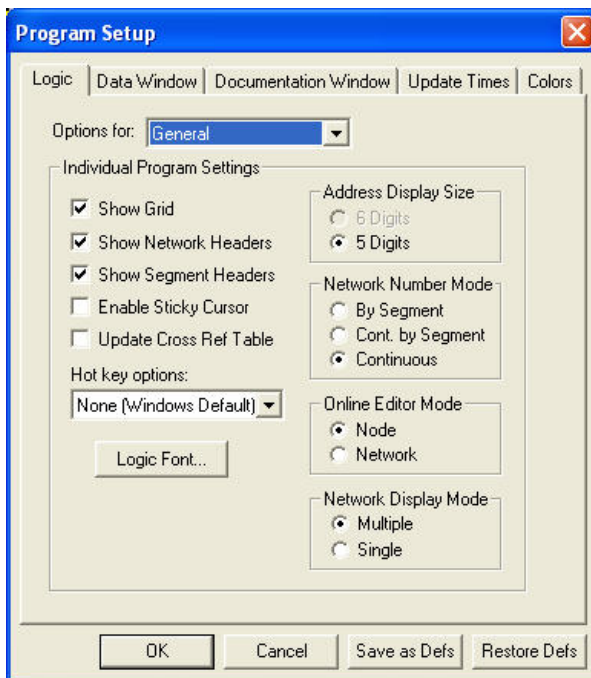

Application Setup

The Application Setup dialog allows you to configure several parameters that are not tied to any one PLC program.

To configure the **Application Setup** parameters:

1. Select the **Options/Application Setup** menu item. The **Application Setup** dialog appears.

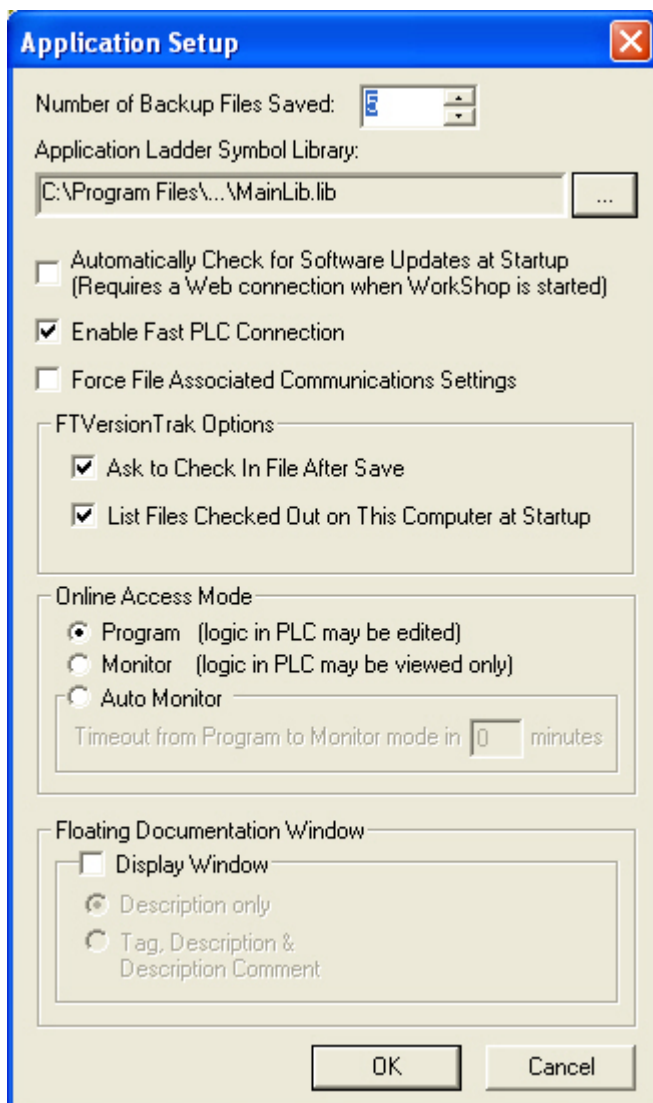

Number of Backup Files Saved: Configure the number of backup files to keep.

Application Ladder Symbol Library: Select the symbol library to be used when displaying or printing ladder logic. See the section entitled *Symbols* for details.

Automatically Check for Software Updates at Startup: If this box is checked, and there is an open Web connection, when WorkShop opens it checks the FasTrak SoftWorks website for new versions of WorkShop.

Enable Fast PLC Connection: If this box is checked, the  toolbar icon and the **File/Fast PLC Connect** and **File/Fast PLC Setup** menu items are enabled. If this box is not selected, online access without a file will be denied from the **Open** dialog.

FTVersionTrak Options: Options related to using PLC WorkShop with FTVersionTrak file change management software.

Online Access Mode: Select the default access mode, which controls whether logic in the PLC can be edited or only viewed.

Floating Documentation Window: If the box is checked, the floating documentation window shows documentation (Description, or Tag, Description, and Comment depending on the option selected) for the address on which the cursor is located.

Force File Associated Communications Settings: This setting forces the user to connect to the PLC using the communication settings associated with the file. See the section titled *File Associated Communication Settings* for more information.

Communications Setup

The **Communications Setup** dialog allows you to configure the way your computer is connected to PLCs.

To access the **Communications Setup** dialog:

1. Select the **File/Communications Setup** menu option.

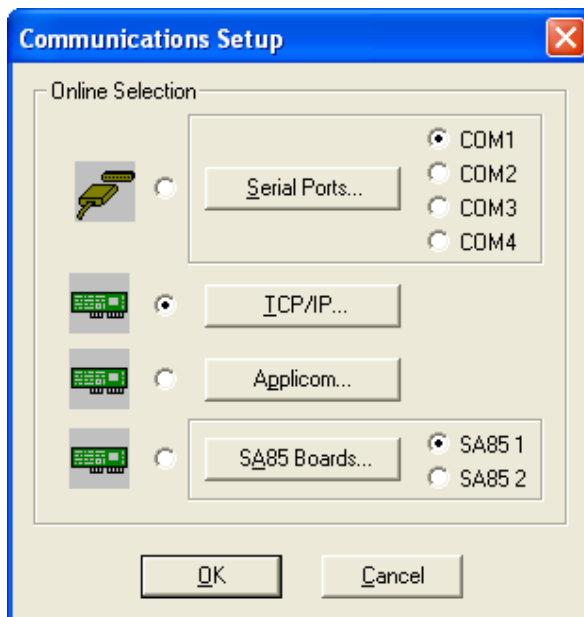

2. Select the option button for the PLC communication method to be used.
3. Configure the details for that communication method by clicking the appropriate button.

NOTE: The settings for the Fast PLC Connection function are set using the **Fast PLC Setup** dialog. Changing the settings here has no effect on the Fast PLC settings.

Serial or Modem Communication

To configure your serial port or modem connection with a PLC:

1. From the **Communications Setup** dialog box, click the **Serial Ports** button, and the **Settings for Serial Ports and Modem** dialog box appears.

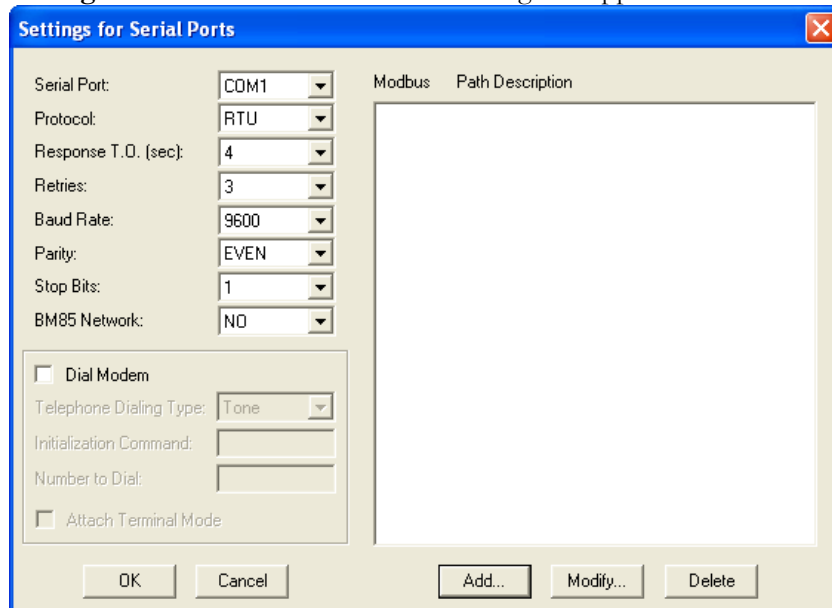

2. Select the appropriate setting for each option in the dialog box.
 - **Serial Port:** Specifies the computers serial port for PLC communications (COM1, COM2, COM3 or COM4).
 - **Protocol:** Specifies the transmission mode. The communications mode toggles between RTU and ASCII.
 - **Response T.O. (sec):** Specifies the amount of time, in seconds, that the software waits for a response from the PLC before returning a time-out error. Any whole number between 5 and 25 can be used.
 - **Retries:** specifies the number of times the software will try to re-establish communications with the PLC after a time-out error. Any whole number between 0 and 10 can be used. Use 0 for no retries.
 - **Baud Rate:** Is the rate of communications between the computer and PLC.
 - **BM85-Network:** Select **NO** if you are not communicating via a BM85 Bridge/MUX or modem. Select **YES** to set a two-minute response timeout for applications using a Bridge/MUX or modem.
 - **Dial Modem:** Is checked if the selected form of serial communications is through a modem. The modem parameters must be set to exactly the same communication parameters that you will use. Use the following modem parameters: eight bits, no parity, one-stop bit, and the highest baud rate that your equipment will support.
 - **Terminal Mode:** This mode is specified in the serial communication setup under the modem group box. This mode exist for a user who need to converse (communicate back and forth) to a modem device before the PLC can be accessed. The “Attach Terminal Mode” check box can only be accessed if the “Dial Modem” check box is checked.

The dialog comes up on an online attach when **Attach Terminal Mode** has been checked in the **Serial Port** settings. Text typed in to the **Send Text** edit box is sent to the modem after an Enter or carriage return.

Currently:

The sent text is not displayed (echoed) in the list box, only responses from the modem.

All carriage returns from modem cause a new line in list box.

All line feeds are ignored in text to list box.

For text from modem to be displayed it must end in a carriage return.

Pressing the **End Terminal Mode** button ends the mode and attempts to attach to the PLC previously chosen.

Telephone Dialing: Specifies which type of dialing to use. Specify pulse dialing only if this is the only type your phone line supports.

Initialization Command: Are initialization commands sent to the modem. Consult your modem manual for a list of appropriate commands.

Number to Dial: Specifies the phone number to be dialed. The number format can be dashes (262-238-8088), spaces (262 238 8088), periods (262.238.8088) or none (2622388088). Commas (,) can be used if a pause is needed to gain access to an outside line before the number is dialed. Example. If 9 is used to gain access to an outside line and there is a pause between the time 9 is pressed and a dial tone. The number entered should be 9,262-238-8088.

Path Description: Specifies a 32-character alphanumeric label for the controller Modbus address. To enter a Modbus address and a Path Description, click the **ADD** button and entering a Modbus address (1-247) and a 32-character alphanumeric label/path description.

3. Click **OK** or press [Enter] to accept the settings. Click **Cancel** to disregard changes and return to the **Communications Setup** dialog box.

Interface Boards

To configure a SA85 interface board for communication with Modicon PLCs:

1. From the **Communications Setup** dialog box, click **SA85** and the **Settings for Interface Boards** dialog box appears.

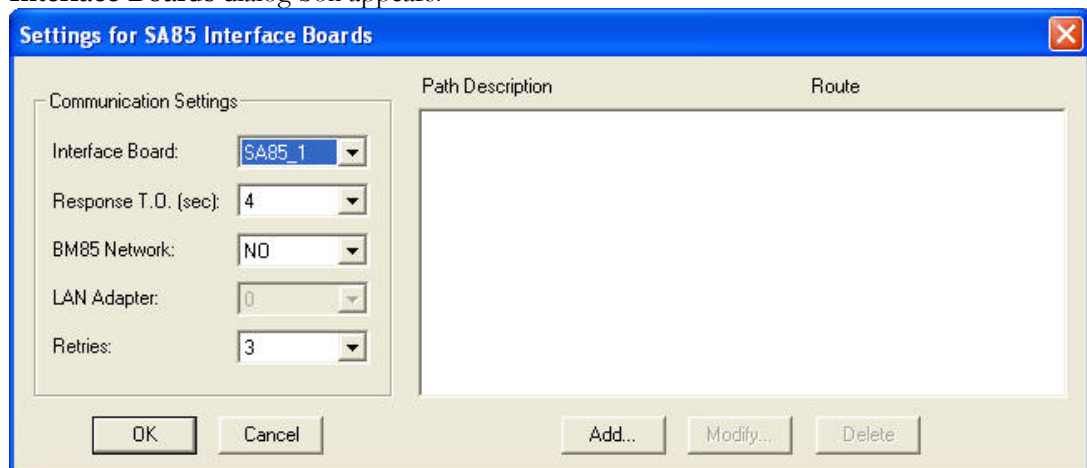

2. Select the appropriate setting for each option in the dialog box.

NOTE: This number must correspond to the value specified for the SA85 board in the DOS operating system CONFIG.SYS file.

- **Response T.O.:** The response timeout is the amount of time the PLC WORKSHOP program waits for a response from the controller before returning a timeout error. Valid values range from 0 to 25 seconds.
- **BM85-Network:** Select **NO** if you are not communicating via a BM85 Bridge/MUX or modem. Select **YES** to set a two-minute response timeout for applications using a Bridge/MUX or modem.
- **LAN Adapter:** Specifies the Local Area Network (LAN) adapter number assigned to the SA85 board you are using. If you have multiple SA85 boards installed, each must have a unique LAN adapter number. Valid values range from 0 to 9.
- **Routing Path:** Specifies the network location of the PLC you want to communicate with. Each set of three integers can be a value from 1 to 247 and identifies a Modbus Plus address. The last address specified is the PLC selected for communications. Any preceding addresses specify the communications path that leads to the desired PLC. To access the routing path, click the **ADD** button and entering a routing address (0-247 in the form of X.X.X.X) and a 32-character label/path description.

NOTE: This number must correspond to the value specified for the SA85 board in the DOS operating system CONFIG.SYS file.

3. Click **OK** or press [Enter] to accept the settings. Click **Cancel** to disregard changes and return to the **Communications Setup** dialog box.
4. Click **Close** in the **Communications Setup** dialog box when you are finished to return to the active logic window.

NOTE: The communication setup options for each communication port are stored in the FASTRAK.INI file located in your Windows directory.

Connect Your PC to Ethernet

Your system administrator must determine what type of cable is best suited for your installation because it affects your choice of Ethernet card for your PC.

In order to communicate to a Modicon PLC, which is connected to a TCP/IP network, a TCP/IP stack needs to be installed on your Windows machine. Windows 95 and Windows NT ship with a TCP/IP stack - WINSOCK.DLL.

If TCP/IP is not listed under the protocol section of your network settings, it needs to be added. You may be asked to insert a Windows disk or CD-ROM. After it has been added, click on properties and enter an IP address, subnet mask, and possibly a default gateway. See your network administrator for more information on these fields if you are not sure what to enter. Every machine on your network must have a unique IP address.

TCP/IP Communication Settings

To configure your interface board port for communication with a PLC:

1. From the **Communications Setup** dialog box, click the **TCP/IP** button and the **TCP/IP Setup** dialog box appears.

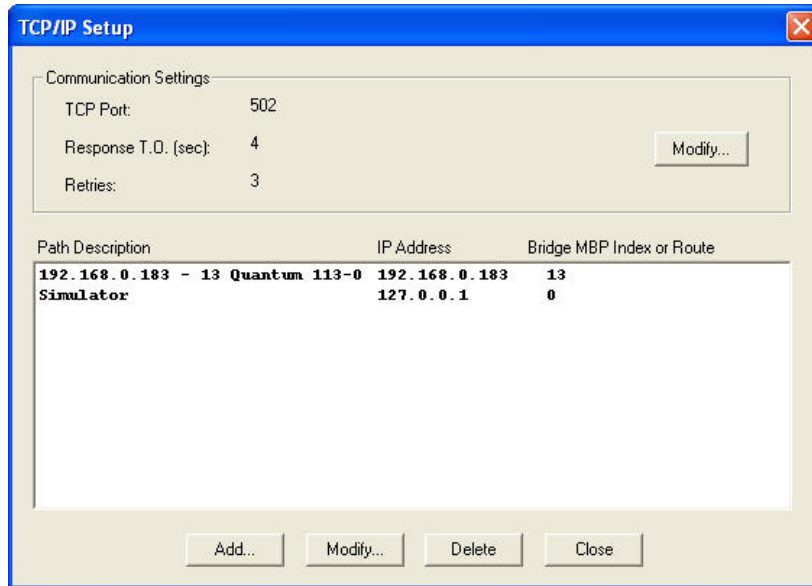

2. From the **Communications Settings** section of the **TCP/IP Setup** dialog box, click the **Modify** button. The **Communication Settings** dialog box will appear.

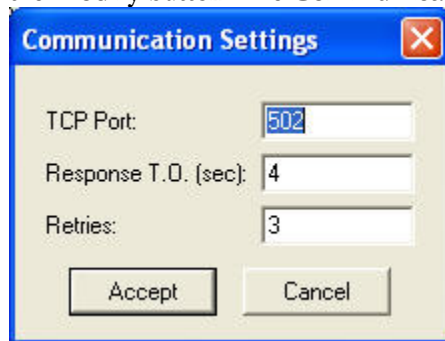

3. Enter a unique **IP Port** protocol number, the response **Timeout**, and number of **Retries**. Then click the **Accept** button.
 - **IP Port:** Any number is acceptable as long as it does not interfere with other protocol numbers.
 - **Response T.O. (sec):** Specifies the amount of time, in seconds, that the software waits for a response from the PLC before returning a time-out error. Any whole number between 5 and 25 can be used.
 - **Retries:** Specifies the number of times the software will try to re-establish communications with the PLC after a time-out error. Any whole number between 0 and 10 can be used. Use 0 for no retries.

IP Addresses

1. From the **IP Addresses** section of the **TCP/IP Setup** dialog box, click the **ADD** button to enter a new IP address, or select an existing IP address and click the **Modify** button to change the IP information. The **IP Addresses** dialog box appears.

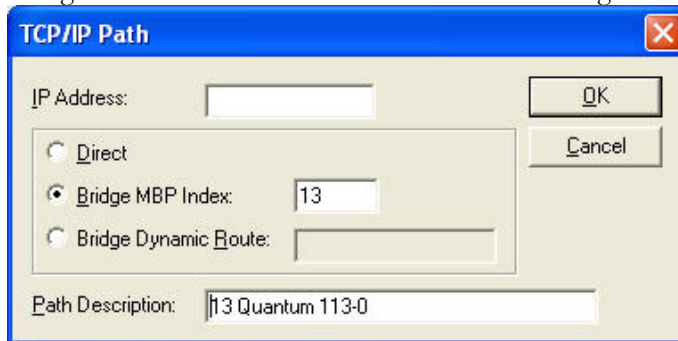

NOTE: The PLC WorkShop allows 1,000 different IP Addresses and Path Descriptions.

2. Enter the **IP Address** for the associated Interface Board. An IP Address is a 32-bit value that is divided into four 8-bit fields; each separated by a period. For example, 192.3.2.1 is an IP Address. Each computer on a network has a unique IP Address. You should consult your network administrator for the correct IP Addresses for your computer and board.
3. Enter the IP Address **Path Description**. A Path Description is a 32-character alphanumeric label for the IP Address.
4. Enter the **Bridge MBP Index** as described in the *Modicon Modbus plus to TCP/IP* manual.
5. Click **OK** or press [Enter] to accept the settings. Click **Cancel** to disregard changes and return to the **TCP/IP Setup** dialog box.

Network Scan

The Network Scan function finds controllers, bridges, bridge multiplexers, and other devices attached to Modbus, Modbus Plus, TCP/IP or Applicom network. PLC WorkShop displays the devices it finds by their address number, and also shows their type and mode status.

To scan the network for devices:

1. From the **Modbus Comm**, **TCP/IP**, **SA85**, or **Applicom Access** dialog box, click **Net Scan**. WorkShop begins to search for devices. While WorkShop is scanning, you can:
 - Click **Stop** to stop the scan when WorkShop finds and displays the device you want.
 - Type in a **Channel** number, then press **Scan** to start a scan at a particular Channel number.
 - Click **Scan** to rescan the network.
2. To select a device, double-click its image, or select the image and then click the **Attach** button.

You can see between 10 and 15 devices in the **Net Scan** dialog box at any given time. If there are more than 15 devices you can use the scroll bar to view the rest. To see the leaves of a branch network double click on the branch and the leaves will appear.

Fast PLC Setup

The **Fast PLC Setup** dialog allows the computer/PLC connection to be configured for use with the **Fast PLC Connection** function.

To set up the Fast PLC Connection:

1. Select the **File/Fast PLC Setup** menu item. The **Fast PLC Connection Setup** dialog appears.

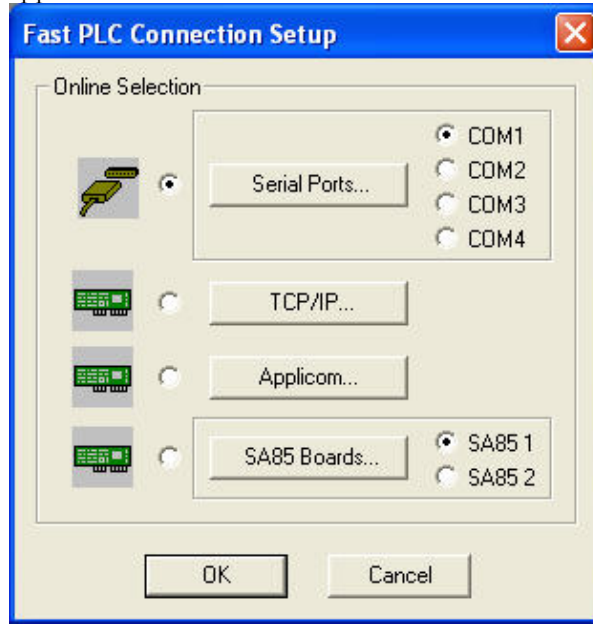

2. Select the option button for the PLC communication method to be used.
3. Configure the details for that communication method by clicking the appropriate button.

The connection options for Fast PLC Connection are stored in the system registry. If Fast PLC Connection is attempted, and the Fast PLC setup has not been configured, the Fast PLC Connection Setup window will automatically display before continuing. To prevent connection by Fast PLC, this dialog may be disabled by deselecting the **Enable Fast PLC Connection** check box in the **Application Setup** dialog. The Application Setup dialog is accessed through the **Options / Application Setup** menu item.

NOTE: The settings for the **Open** function are configured using the **Communications Setup** dialog. Changing the settings for **Fast PLC Connection** has no effect on the **Open** settings. Files cannot be loaded with **Fast PLC Connection**. To load a file online, use the **Open Program** dialog, which is accessed through the **File** menu.

File Associated Communications

When a file is successfully loaded online in WorkShop, the communication settings are associated with the file so the next time a user wishes to go online with the same file, WorkShop will default to these settings. Communication settings associations are made by writing a block of data to a binary file with the extension *.FTRF (FasTrak Route Format), located in the same folder as WorkShop.

The next time a user loads a WorkShop program file, the associated communication settings appear in the Open Program dialog.

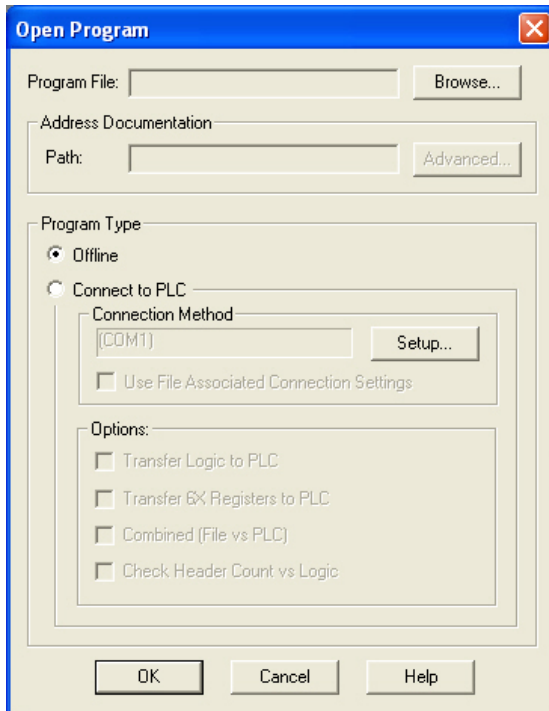

Select the **Use File Associated Connection Settings** check box to accept the connection method associated with the file, or click **Setup** to view or edit **Communication Settings**.

NOTE: Selecting Force File Associated Communications Settings in Application Setup will force the user to connect with the saved settings.

Printer Setup

Use Print Setup to select a printer and determine where and how your printouts appear.

To access the Print Setup:

1. Start or open a logic program.
2. Select **Print Setup** from the **File** menu. The **Print Setup** dialog box appears.

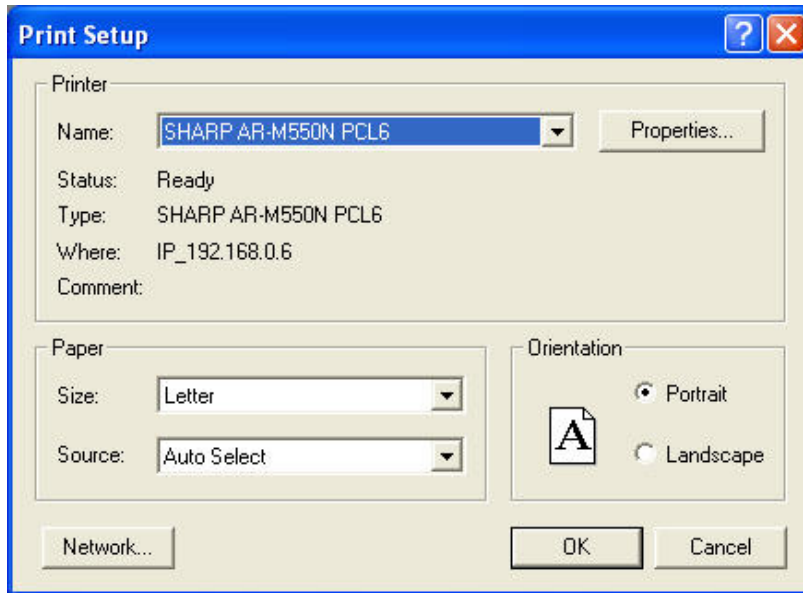

3. Choose a printer or device from the drop down box.
4. Additional setup options may be available depending on the printer you selected. If a **Properties** button is available, click it and another dialog box appears. Make your selections and select the **OK** button to return to the **Print Setup** dialog box.
5. Other options in the **Print Setup** dialog box include **Orientation** and **Paper Source**. Click the desired settings.
6. Click **OK** in the **Print Setup** dialog box to save your settings and return to the active logic window.

NOTE: The print setup options can also be accessed from the **Print** box that appears after selecting **Print** from the **File** menu.

Page Setup

Use Page Setup to select page margins, starting page number and whether to include a Title page in your printout.

To access the Page Setup:

1. Start or open a logic program.
2. Select **Print** or **Print Preview** from the **File** menu. The **Print** or **Print Preview** dialog appears.
3. Click the **Page Setup** button. The **Page Setup** dialog box appears.

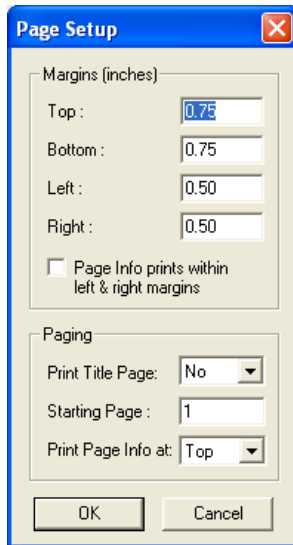

4. Enter the desired margins in inches.
5. If you would like to start your printout with a page number other than 1, change the **Starting Page** number.
6. To include a title page, showing the program name, date, and time, select **Yes** in the **Print Title Page** drop-down list.
7. Click **OK** to save your settings and close the dialog.

Page Setup for Output to Text File

Use Page Setup to define the page size and printer codes, starting page number and whether to include a Title page in your text file output.

To access the Page Setup for Output to Text File:

1. Start or open a logic program.
2. Select the **File/Output to Text File** menu option. The **Print Output to Text File** dialog appears.
3. Click the **Page Setup** button. The **Page Setup** dialog box appears.

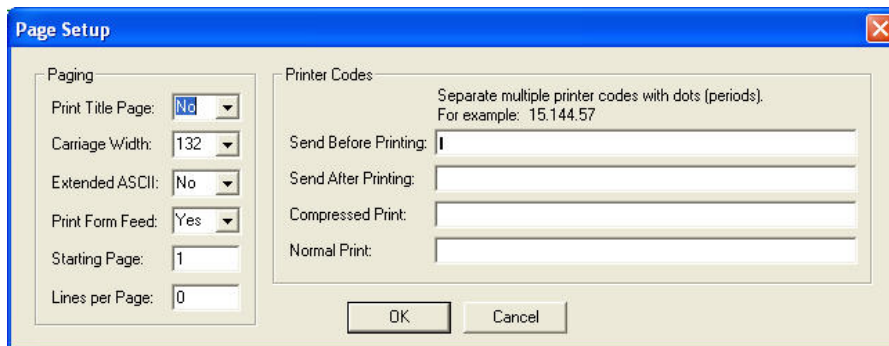

4. Set the parameters:
 - **Print Title Page** - To include a title page, showing the program name, date, and time, select **Yes**.
 - **Carriage Width** - Select 80 or 132 characters from the drop-down list. These are the standard carriage widths. Other carriage widths may be typed.
 - **Extended ASCII** - Select **No** to use standard ASCII, **Yes** to use extended ASCII. The main difference is that standard ASCII does not include line-drawing characters, and uses '-', '+', and '|' instead.
 - **Print Form Feed** - Select **Yes** to use a form feeds to end a page. Select **No** to use carriage returns.
 - **Starting Page** - Enter the page number for the first page in the report. Must be a number greater than 0.
 - **Lines per Page** - Enter the number of lines per page. This number determines how much information can be printed on a page. If **Print Form Feed** is set to **No**, this number must be precise because it is also used for page alignment. This number includes lines for page headers and footers.
 - **Printer Codes** - Enter the printer-specific codes for each function. Refer to your printer manual for details.

5 - FasTrak Authentication and NT Security

Overview

The WorkShop **Password Security** feature allows one or more security administrators to maintain a list of users and their access privileges. Access privileges restrict which functions of the application (such as online and offline editing, I/O forcing, loading, saving changes to disk, and so on) that individual users can perform.

Choosing a Security Type

PLC WorkShop for Modicon 32-bit offers two unique security systems for use. To activate the security features of PLC WorkShop, select the **Options/Security/Administrator Options** menu item as illustrated below.

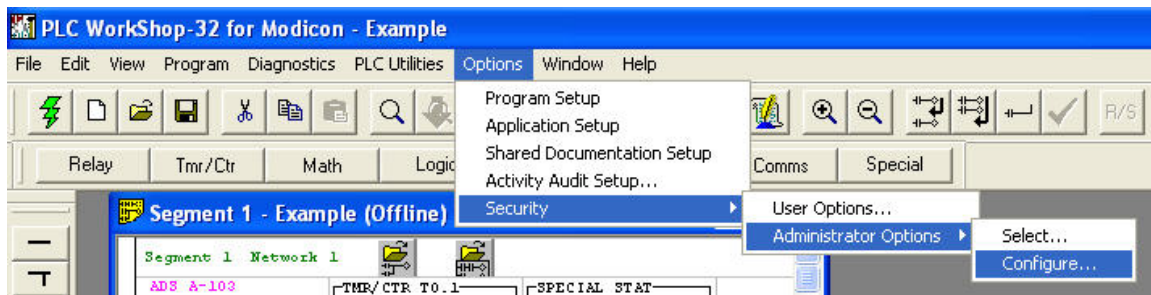

If PLC WorkShop is running under Windows 95, 98, or ME, the **Password Required** dialog appears as illustrated below. This dialog appears after having chosen a security type for the first time and allows the user to become the first security administrator.



If the computer on which PLC WorkShop is installed is running under Windows NT, 2000, or XP, PLC WorkShop determines if the user currently logged in to the operating system is an administrator (or belongs to the Administrator group). If the user already belongs to the Administrator's group, then the fields above are filled in and the dialog is used to verify the user's password. Clicking **OK** launches the **Security Type Selection** dialog, seen below.

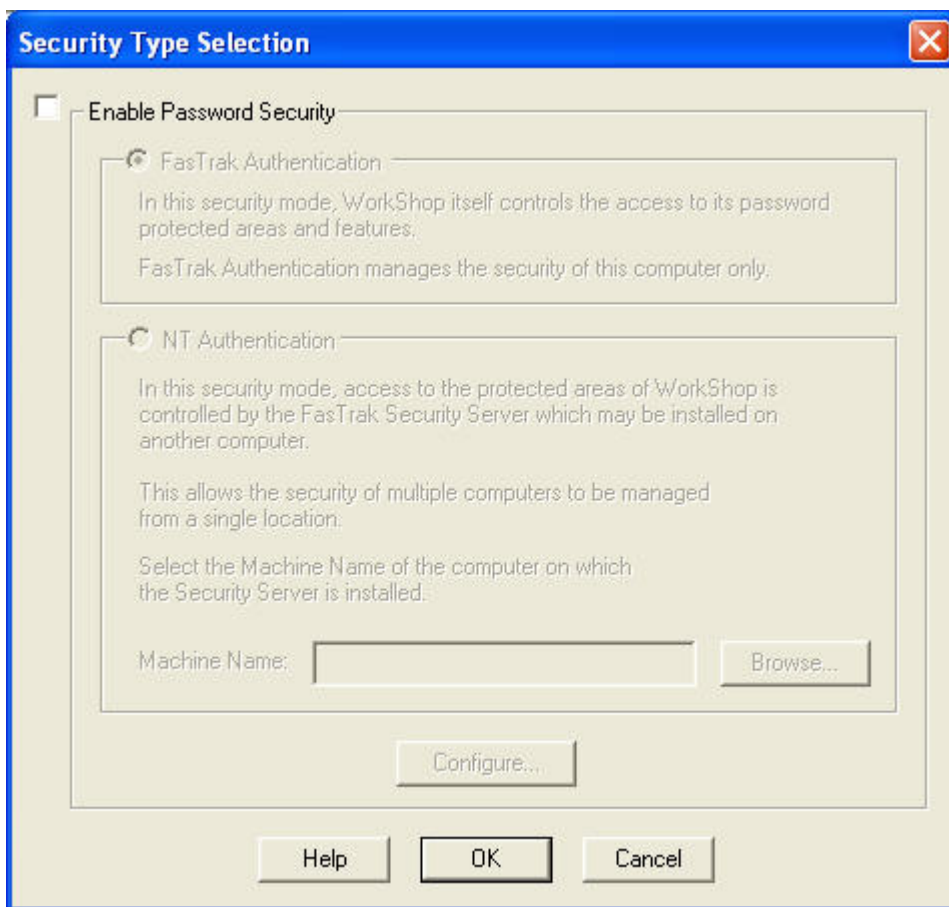

Click on **Enable Password Security** to enable security type selection, and choose from either FasTrak Authentication or NT Authentication.

FasTrak Authentication: The application itself regulates user access to password-protected areas. Management takes place on the local computer only. More information on FasTrak Authentication appears in the next section.

NT Authentication: When enabled, PLC WorkShop requests permission to access password-protected areas from the **FasTrak Security Server**. This server is a separate application, which can be installed on the local computer or on any other computer running under MS-Windows, NT, 2000, or XP. This server is capable of managing multiple computers from a single, central location. See *NT Authentication Security* for more information.

FasTrak Authentication Security

FasTrak Authentication Security Configuration Dialog

Access the Authentication Security Configuration dialog by clicking the **Configure** button within the **Security Type Selection** screen.

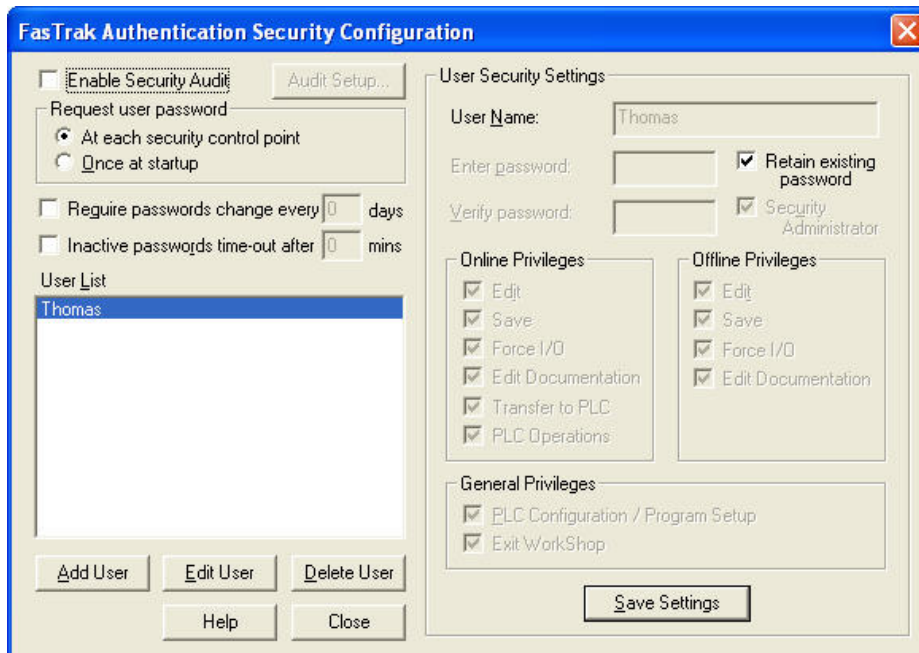

In addition to controlling user access, this security mode can also record each attempt made by a user to perform the tasks displayed above. To enable this feature, click on the **Enable Security Audit** check box.

NOTE: If the **Enable Security Audit** check box is checked but the security log has not been set up, when this dialog is exited, PLC WorkShop will warn the user that no log file had been configured, and the check box selection will not be retained.

FasTrak Authentication Security Audit Setup

The following dialog is launched from the **FasTrak Authentication Security Audit Setup** dialog by clicking **Audit Setup**.



To write the local security log to a Microsoft Access database file, select the **Microsoft Access** radio button. Enter the name of the Access file or browse to select a file and select a file format from the drop-down menu.

To write the local security log to an SQL database file, select the **Other Database** radio button. Enter the file **Connection String** in the text box.

Data Link Properties Dialog

If choosing a database other than Microsoft Access and you have no Connection String, click the **Select** button, and the **Data Link Properties** dialog opens. This dialog is the first in a series of tabbed dialogs that help users create the necessary string of the local security log file.

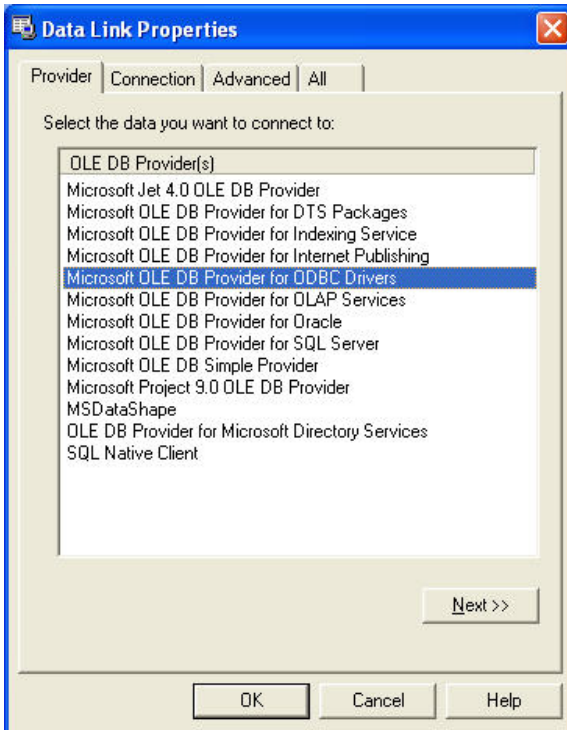

Password Security Setup

Password security in WorkShop is disabled by default. Without password security enabled, any user may access any portion of the programming package.

Before the password security feature can be used, a security administrator must be established by selecting the **Options/Security/Administrator Options** menu item.

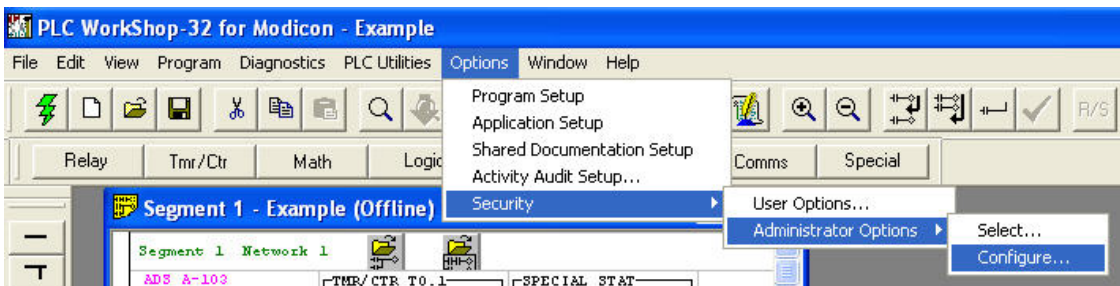

The **User Options** menu item allows users to change their own passwords or allow other users to enter their password without having to exit and restart WorkShop.

The **Administrator Options** menu item allows the security administrator to add, edit, and delete users and specify their access privileges to specific features in WorkShop.

Administrator Options

By default, there is no security administrator, and the password security feature is not enabled. Therefore, the **User Options** menu item is disabled until a security administrator is established. Select the **Options/Security Setup/Administrator Options** menu item to establish a security administrator. The **Password Required** dialog appears.

The image shows a Windows-style dialog box titled "Administrator Password Required". The dialog has a blue title bar with a close button (X) in the top right corner. The main area is light gray and contains the text "Please enter your security administrator name and password." Below this text are three input fields: "Name:" with a single-line text box, "Password:" with a single-line text box, and "Verify password:" with a single-line text box. At the bottom of the dialog are two buttons: "OK" and "Cancel".

1. **Name:** The security administrator is required to enter a name, which can be up to twenty characters long.
2. **Password:** The security administrator is required to enter a password, which can be up to fourteen characters long. Both alphanumeric characters as well as other keyboard-entered characters such as !, @, #, \$, and % are valid.
3. **Verify password:** The first time a security administrator is established, the password must be entered twice. This original security administrator can add other security administrators through the FasTrak Authentication Security Configuration dialog discussed below. If a security administrator has already been established, the password does not need to be entered a second time for verification. When a security administrator exists, the **Verify password** field is disabled.
4. Click **OK**. If the two passwords match, the **FasTrak Authentication Security Configuration** dialog appears.

Security Administration Dialog

Security administrators control the password security feature of WorkShop through the **FasTrak Authentication Security Configuration** dialog.

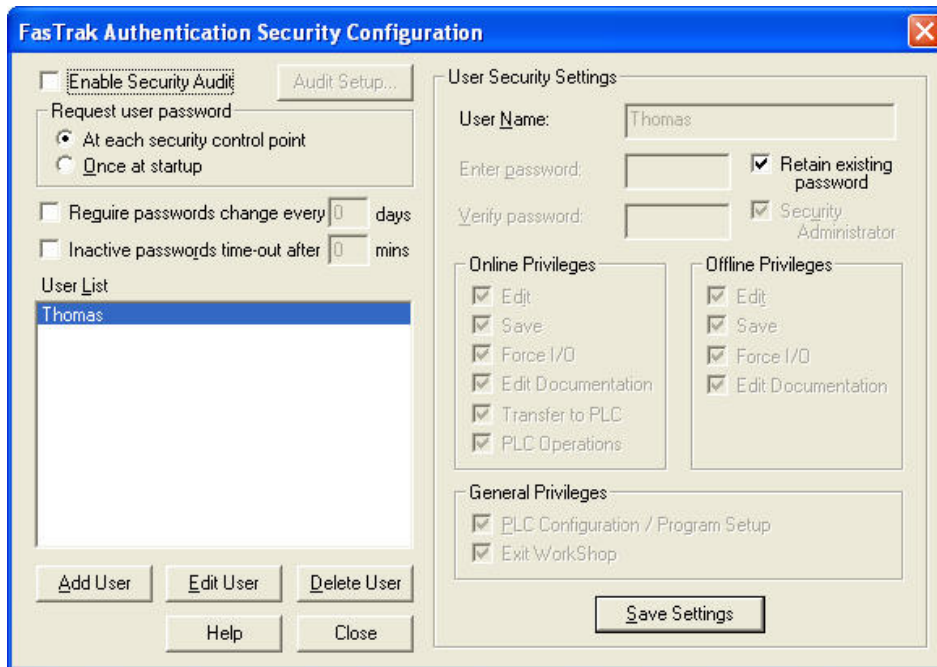

The security feature can be enabled and disabled and the places at which user passwords are requested can be specified through this dialog. The list of users and their rights to access specific features within WorkShop can be managed within this dialog.

Enable Password Security

The password security feature is disabled in WorkShop by default. The security administrator can turn this feature on by checking “Enable password security”. When this box is checked, users are requested to enter their passwords either once each time WorkShop is started or each time they attempt to enter a password-protected section of the application.

The current security mode is indicated in the status bar at the bottom of the WorkShop window as seen in the example below. **Security: Enabled** appears when security is enabled. **Security: Disabled** appears when security is disabled.

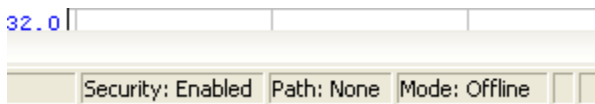

Inactive Passwords Timeout in N Minutes

Once users enter their passwords, they can operate PLC WorkShop indefinitely (within their access privileges). However, if PLC WorkShop runs unattended for a designated number of minutes without user interaction, the password under which the application is running can be timed-out.

Click **Inactive passwords time-out after N mins** to activate this feature. Enter the number of minutes PLC WorkShop may remain inactive before the current password times-out. The default number of minutes is 30 but the valid range is 1 to 999.

Request User Password

Once password security is enabled, PLC WorkShop requests users to enter their passwords at various times to operate the software.

Passwords can be requested each time users attempt to enter a password-protected portion of the application. Alternately, passwords may be requested only once when WorkShop is first started.

At Each Control Point

Password control points are designated as “privileges” within the **User Security Settings** group box illustrated in the following pages. Specifying that passwords be requested at these control points requires users to enter their name and password every time they attempt to use these features.

The advantage of this selection is that multiple users can operate WorkShop without having to exit and restart the application under another user name and password. Once a user has completed a password-protected operation and exits that function, other users can access password-protected operations by entering their own user names and passwords.

The disadvantage of this selection is that it requires users - even the same user - to re-enter user names and passwords each time they attempt to access one of the password-controlled features.

For example, saving a program to disk is one of these control points. Assume a user edits a ladder program. The user then selects **Save** from the **File** menu to write the changes to disk. The **Password Required** dialog box, pictured here, appears requesting the user name and password to access the save feature.



Upon entering a valid user name and password (and the security administrator has given this user privileges to this feature), the user is granted access to the save feature. After saving, the user immediately returns to the program, makes another change, then selects **Save** from the **File** menu again. Even though the user was just granted access to the **Save** feature, the **Password Required** dialog reappears requesting the user name and password.

Once At Startup

Alternately, user name and password can be requested once when WorkShop is started – or after selecting **Switch user** in the **User Security Setup** dialog, illustrated later in this document. Upon entering a valid user name and password, the new user can access each password-controlled feature (to which the security administrator has granted privileges) without having to re-enter the user name and password.

The advantage of this selection is that users enter their names and passwords once at startup and are not required to re-enter them each time they choose a password-controlled feature.

The disadvantage of this selection is that one user can start WorkShop with a correct name and password but another operator can continue to use the application with all the original user's access privileges.

Adding Users

Click the **Add User** button to add a new user to the list. The dialog controls for a new user are set as illustrated below.



User names can be up to twenty characters long. Passwords can be up to fourteen characters long. Valid characters for both fields are alphanumeric and the other keyboard-entered characters (! @ # \$ %, etc.).

Enter the user name then enter and re-enter the password.

All privileges are initially checked for new users. Check/uncheck the privileges appropriate for the user.

Security administrators can create other security administrators. Check the **Security Administrator** box to grant the new user all administrator rights and privileges.

Click **Save Settings**. The list of existing users is checked to assure the new user name is not a duplicate. If the new user name is unique, the two password entries are compared. Finally, the new user name is added to the **User List** box.

Editing Users

There are two ways to select an existing user to edit. Either double click a user name from the **User List** box or highlight a user name in the **User List** box and click the **Edit User** button.

By default, **Retain existing password** is checked and the password edit boxes are disabled. This allows the security administrator to modify privileges without needing to re-enter the user identity information (the user name and password).

To change the user name, type an alternate entry in the **User Name** edit box.

To change an existing user password, uncheck **Retain existing password** to enable the password edit boxes. Enter and verify a new password. Both password entries must match in order to save the new password.

Security administrator rights may be granted to or revoked from the user by checking or unchecking **Security Administrator**.

Deleting Users

To remove a user, highlight a name in the **User List** box and click the **Delete User** button. A verification message appears which asks to confirm the deletion. Click **OK** and the user is removed.

User Security Setup

User Security Options Dialog

Once the security administrator adds users, their initial passwords and access privileges, the **User Options** item of the **Security Options** menu (as illustrated earlier) is enabled. Users can select this menu item to change their passwords through the **User Security Options** dialog below.

If the security administrator elects to request user passwords once at startup, the **Switch User** radio button is enabled. Otherwise, if passwords are requested at password control points, this radio button is disabled.

Changing the User's Password

Users may change their own passwords. Security administrators may also change their passwords. Click the **Change user password** radio button and the dialog controls are set as illustrated below.



Enter the user name and current password. Then enter and verify the user's new password and click **OK**.

If the entered user name is in the list of users previously added by the security administrator, the **Enter current password** is compared to the password already associated with that user.

If the **Enter current password** matches the existing password for that user, the **Enter new password** and **Verify new password** are compared with each other. If the two new passwords match, then the new password replaces the current.

Switching the User

If user passwords, specified by the security administrator, are requested only once when WorkShop is started, the password entered at startup (and the access privileges associated with it) is in effect until WorkShop is exited. Another password is not requested until WorkShop is restarted.

However, the **Switch user** name and option allows another user to enter another password without requiring the application be exited and restarted.

Enter the user name and password of the user who will assume operational control of WorkShop. If a valid user name and its matching password are entered, the security access privileges are reset to those of the new user.



NT Authentication Security

Overview

The FasTrak NT Authentication Server uses Windows NT security. NT Security is a feature that is part of the Windows NT Operating System and is also found in Windows 2000 and XP. The server must therefore be installed on a machine running Microsoft Windows NT (3.1 or later), Windows 2000, or Windows XP. The following hardware requirements are recommended.

A personal computer with an Intel Pentium 100 processor or higher.

32 MB or more of RAM.

An 800 X 600 VGA monitor with at least 256 colors.

100 MB free disk space on your hard drive.

NOTE: Both the FasTrak Security Server (FTSecSvr.exe) and the FasTrak Security Configurator (FTSecCfg.exe) must be installed and configured prior to activating and utilizing these features.

The Security Server Application (FTSecSvr.exe) handles all client requests to access secured FasTrak features. The server grants or denies access to a feature request depending on the configuration provided by FTSecCfg. When security is enabled for FasTrak applications, all secure features are inaccessible unless security is configured via FTSecCfg and the security server is running. All NT auditing including security and application audits are handled by the server. Security audits are configured in FTSecCfg and application audits are configured in the FasTrak applications that support security. The Security Configurator (FTSecCfg) is an application that is used to set up user privileges within the client.

Breakdown of steps for installation, configuration, and use:

1. **Installation:** The procedure for installing both the Security Server and Configurator on local and remote machines (the Server must be installed regardless of operating system and whether it is ran locally or remotely)
2. **WorkGroups and Domains:** Details to how both relate to NT Security
3. **Configuring Users and Groups:** Procedures for adding and setting up groups for the variety of supported Operating Systems
4. **Configuring User's Rights and Audit Policy:** Instructions for configuring specific user rights and audit policy on the machine to which the server will be running from
5. **DCOM (Distributed Component Object Module) Configuration:** Instructions for configuring DCOM on the available variety of Operating Systems and how to setup the Security Administrator
6. **Security Configuration:** Specific instructions for how to setup, configure, and launch the Security Configurator. Also, instructions for configuring the users, groups and auditing features as well as the Event Viewer, used to view generated logs.

Installing the Security Server

If the FasTrak client applications are installed on a machine other than the one FTSecSvr is running on (remote security), users may want to install FTSecCfg on the client machine(s) as well as the server machine so that the server can be configured locally or from the client machine.

FasTrak security must be installed on a machine running Windows NT (3.1 or later), 2000 or XP. Two applications get installed to a user-selected directory on the local machine. These files are **FTSecCfg.exe** and **FTSecSvr.exe**. If running Windows XP, FTSecSvr.exe can only be installed on the Professional version and not on the Home version. Regardless of the operating system being used, the server (FTSecSvr.exe) must still be installed locally on the client machine as well as on the remote machine. This is true even if the client machine is a non-NT type machine. By default, all “checkable” items get installed including FTSecSvr.exe (under NT Security\Server) and FTSecCfg.exe (under NT Security\Configurator). If installing to Win9x or Me, NT Security\Configurator is not listed and therefore FTSecCfg.exe does not get installed.

Installing and Running the Server on a Local Machine

If the user wishes to install the Security Server locally, this may be achieved by installing from off of CD or from a self-extracting executable file available from FasTrak’s Website (<http://www.fast-soft.com>).

A CD installation requires only that all items for security be checked during the InstallShield process. If a client software application has been previously installed, and it supports NT Security, then re-inserting the installation CD or running the self-extracting executable and un-checking the client during the InstallShield process is all that is required.

Installing and Running the Server on a Remote Machine

Installation begins with the installation of the client (i.e. PLC WorkShop) to a local, or client, machine. In this case, installing the Security Configurator is an option.

After this installation is complete, the user must install to the machine that will act as the remote server. Installation is identical to the above with the exception that the client need not be installed and therefore may be unchecked from InstallShield. It is recommended that both the Security Server (FTSecSrv) and Configurator (FTSecCfg) be installed.

If a client software application is already installed to the machine that the user wishes to run as the remote security server, installation of security is identical to installing to a local machine, in the above section.

Installation Dialogs

The following dialog is an example of what a user should expect to see during installation. Below is the dialog whereby the user selects to install the client application, security, or both.

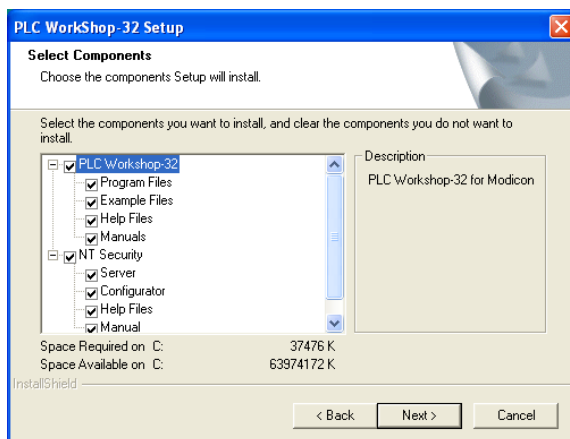

Select or deselect security components, with the NT Security check box selected, and click on the **Next** button.

Workgroups and Domains

Workgroups

NT security works slightly different in workgroups than in domains. This difference becomes a factor when using the security server remotely. When a computer is part of a Workgroup and a user enters their user name and password to log onto the operating system, the user name they logged in as, the rights they have, and groups they belong to are known only to the local computer.

When a local computer (running a client application such as PLC WorkShop) connects to a remote computer running the security server, it tries to log on to the remote computer with the same user name and password. If the exact user name and password cannot be found on the remote computer, the client (local computer) gets logged onto the remote computer as “Guest”. For this reason, a guest user normally has minimal rights. This account is disabled by default. If a guest account is enabled, anyone can log on to the computer because a password is not required for this account. In general, when using workgroups, all users that need to get security clearance from FasTrak’s security server must exist on the server machine. The rights a user has on the local machine may differ from the rights they have on a remote machine. Similarly, the groups a user belongs to on the local machine may differ from the groups they belong to on a remote machine.

Domains

When a computer is part of a Domain and a user logs onto any computer that is a member of the domain, the user name and password they supply is stored on the domain controller vs. the local machine. There is no “re-logging” when connecting to a remote machine on a domain. The rights a user has and the groups they belong to are the same amongst all the machines on the domain. This eliminates the need to declare users twice: once on the local machine and once on the remote machine. When setting up a server on a domain, its important to choose the domain controller machine because this machine holds all the domain users and groups.

Adding Users and Groups to the Operating System

Configuring users and groups differs depending on the operating system being used. Because NT Security is based on Users and Groups, the following steps must be taken.

Adding Users for Windows 95, 98, and ME

In Windows 9x and Me, users may log on to the system to get their unique user profile, but they do not have any rights since the operating system is unprotected and they do not belong to any groups. A user can be created simply by entering a unique user name and password when logging on to the OS. A user may skip the login procedure altogether, in which case they become the **Guest** user.

Adding Users for Windows NT

In Windows NT, users and groups can be created by entering **Administrative Tools** from **Control Panel** and selecting **User Manager**. This is shown in the figure below.

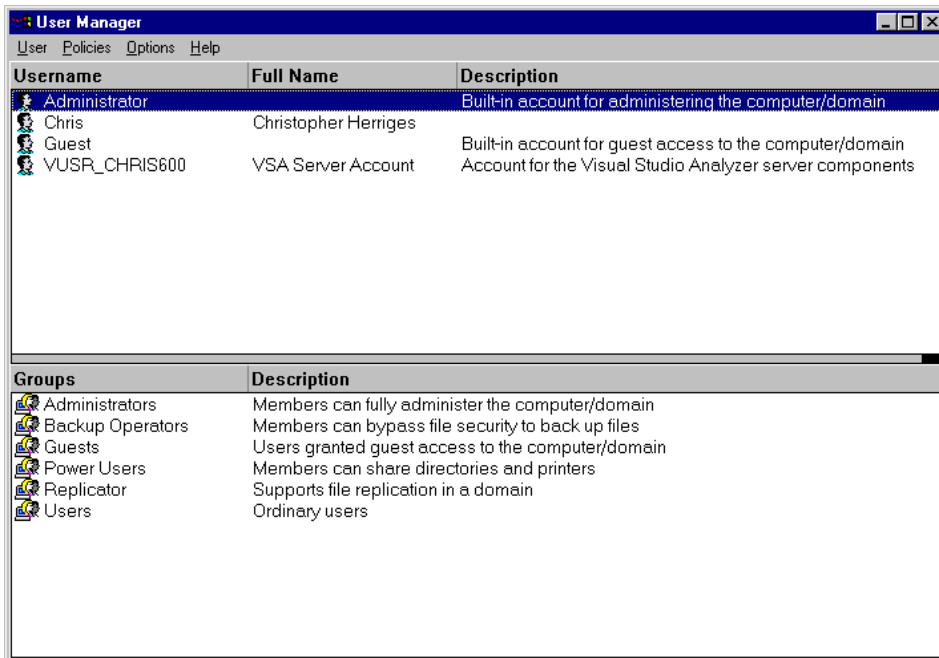

Adding Users for Windows 2000 and XP

In Windows 2000 and XP, users and groups can be created by entering **Administrative Tools** from **Control Panel** and selecting **Computer Management**. Within the Computer Management application, users and groups can be created by right clicking on the corresponding folders under the **Local Users and Groups** tree item as illustrated in the following figure.

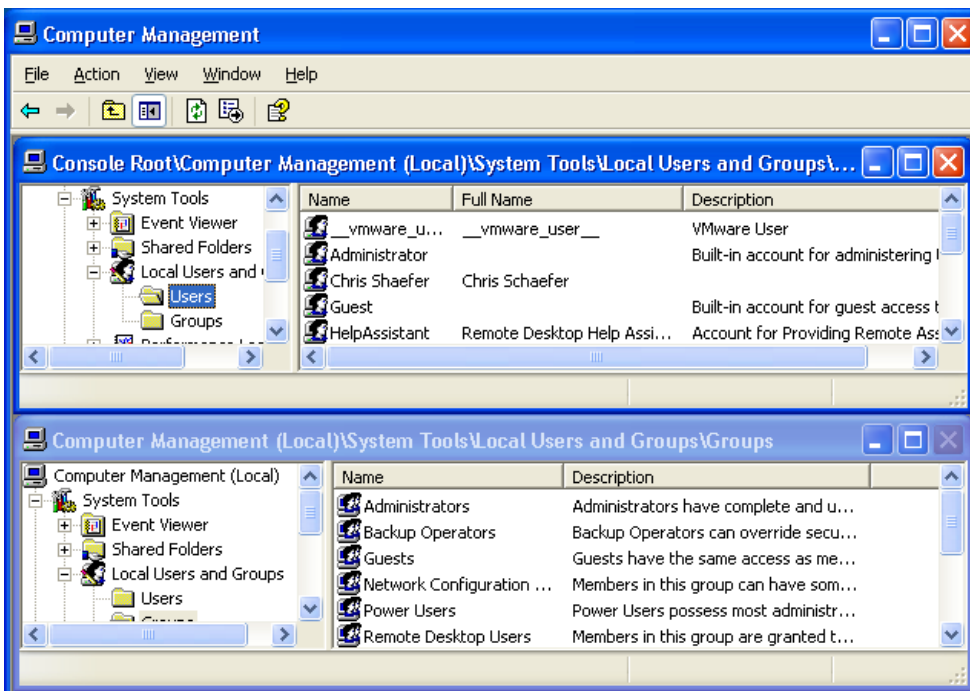

Adding Users and Groups on a Domain Controller

If on a domain controller, select the **Administrative Tools/Active Directory Users and Computers** menu item. From the tree control, right-click on the **Users** folder to add users and/or groups.

Configuring User Rights and Audit Policy

Correctly configuring specific user rights and audit policy on the server machine is essential for proper security and for the server to operate correctly. The following user rights need to be configured:

Access this computer from the network: Enter all users/groups that will need to access this computer from the network. These users will represent the server's clients that need to request security clearance.

Deny access to this computer from the network: Make sure that any user/groups that are listed in the above right are not listed here.

Generate security audits: A user with administrative rights should be added here. This should be the same user that the server is launched under. See *DCOM* in the *Centralized Security Server- Server Configuration* of this manual. This right should be configured even if security audits are not used. This Administrator will be referenced later in this manual, in the section dealing with DCOM.

Manage auditing and security log: A user with administrative rights should be added here. This should be the same user that the server is launched under. See *DCOM* in the *Centralized Security Server- Server Configuration* portion of this manual. This right should be configured even if the logs are not used. Note: this is the same Administrator as mentioned in the above point.

Configuration location differs depending on the operating system you are on. In Windows NT, enter the User Manager and choose the **Policies / User Rights** menu item. If interested in generating security audits, select the **Policies / Audit** menu item in the User Manager. From this dialog, check the **Success** and **Failure** buttons next to **File and Object Access**.

In Windows 2000 and XP, users rights can be modified in the **Administrative Tools** Control Panel, under **Local Policies**. While on a domain controller, users rights may be modified in the Administrative Tools under **Domain Controller Security Policy**. From either application, right-click on the **User Rights Assignment** to list all user rights.

To enable security audits, click on **Local Policies / Audit Policy** from within **Local Security Policy**. Double-click on the **Audit Object Access** policy and check both **Success** and **Failure** boxes. The computer's operating system must have the latest service pack installed as this fixes auditing problems with earlier releases.

The following table may assist a user in determining what rights must be given to a user on the machines involved in FasTrak's NT Authentication Security.

Remote Server Machine	Local Server Machine	Client Machine
Access this computer from the network	Generate Security Audits	N/A
Generate Security Audits	Manage auditing and security log	
Manage auditing and security log		

NOTE: It is mandatory that you reboot the machine for the new user rights to take effect.

Configuring DCOM for NT Authentication Security

The machine that the user wishes to run FTSecSvr (FasTrak Security Server) on must be configured for proper server/client communication. Below are the needed steps for configuring the server.

Configuring DCOM on Windows 9x, 2000, and NT

DCOM enables FasTrak clients, such as PLC WorkShop for Modicon to communicate with remote security servers. The dialog window, shown below, is launched by running **dcomcnfg.exe** from a DOS prompt or by clicking on the Windows **Start** button followed by clicking **Run**. Changes made in DCOM are applied immediately and there is no need to reboot the PC.

Instructions for Configuration

1. In the **Applications** list box, scroll down and select **FTSecSvr**. If this item is missing, it was not properly installed; refer to earlier sections in this manual.

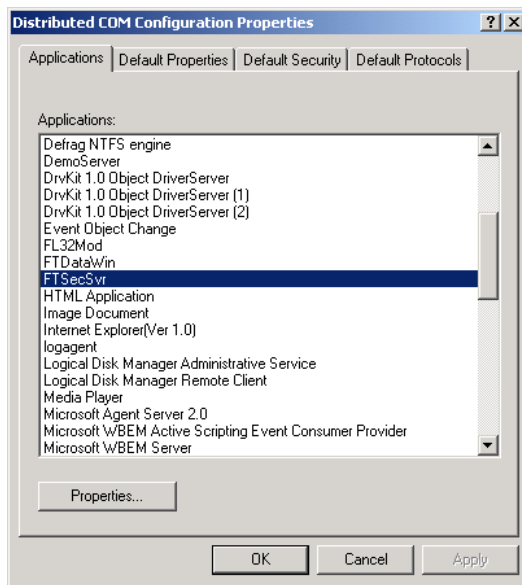

2. Click the **Properties** button. The **Properties** dialog window opens.

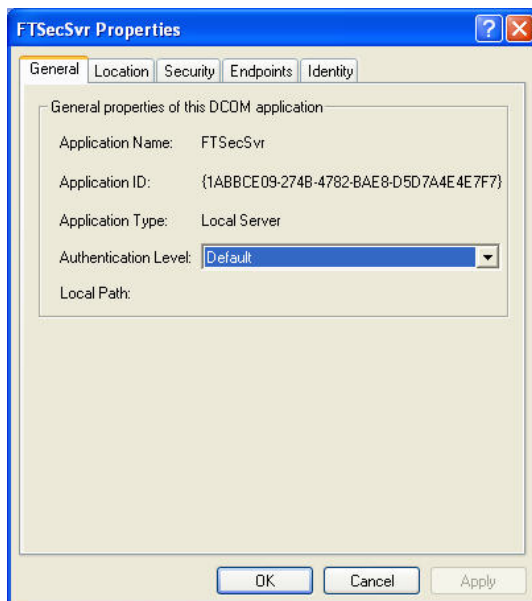

3. Click the **Security** tab.

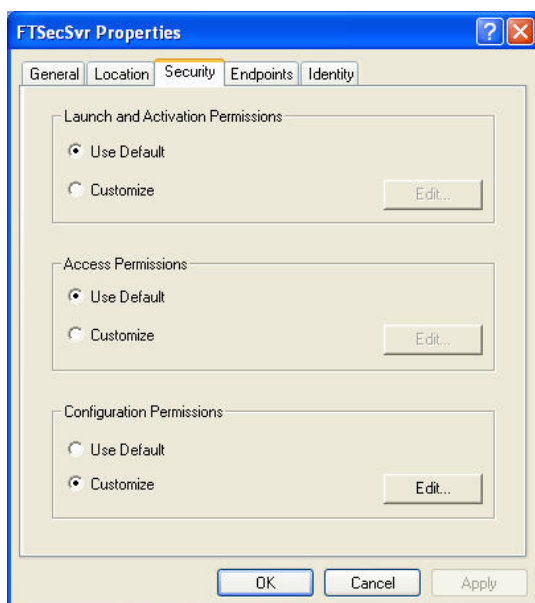

4. Under **Security**, choose the **Administrator** (See *Configuring User Rights and Audit Policy*) who will have access permission. The following affects both the areas of Access and Launch. For Custom security for **Launch and Access Permissions**, follow these steps.
 - a. While in the **Properties** dialog, with the **Security** tab active, click on **Edit**.
 - b. Click **Add** and choose the Administrator.
5. Click the **Identity** tab and click the **this user** radio button.

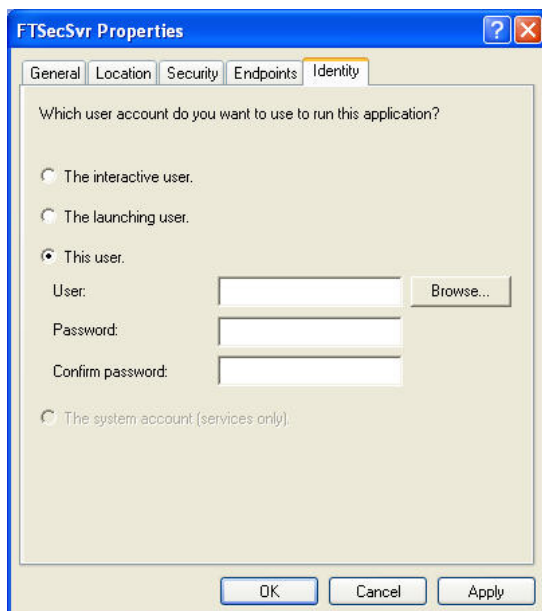

6. **Browse** and select the Administrator. Click **OK** to return to the main dialog.

7. Finally, click the **Default Properties** tab and choose **connect** for Default Authentication or **impersonate** for Default Impersonation.

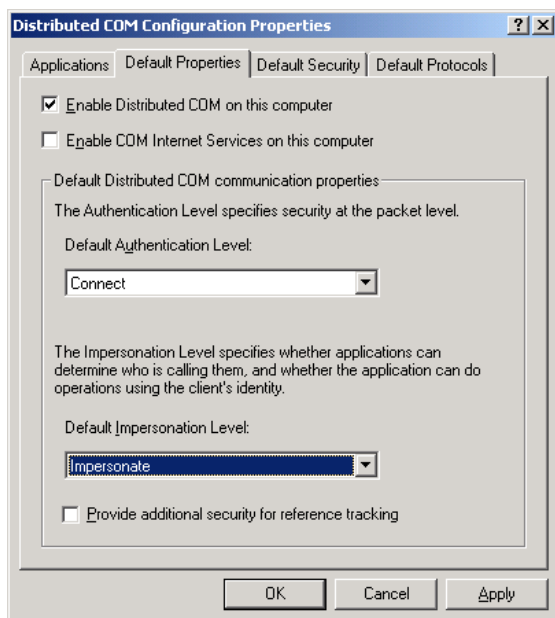

8. If the server is on a remote machine, repeat Step 7.

Configuring DCOM for Windows XP

Configuring DCOM under Windows XP begins with launching the application, **dcomcnfg.exe**, from a DOS prompt or the **Run** dialog, just as in the previous instructions. The following dialog launches.

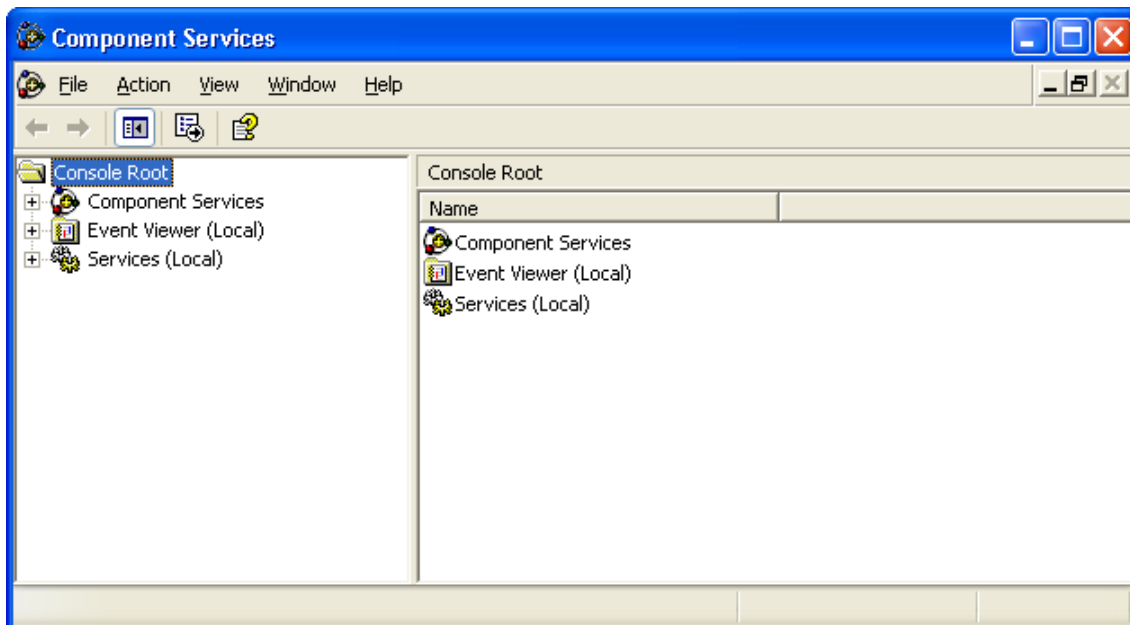

Using the tree structure in the left-most pane, expand the selection of **Component Services** to **Computers** and then to **My Computer**, as illustrated in the following dialog.

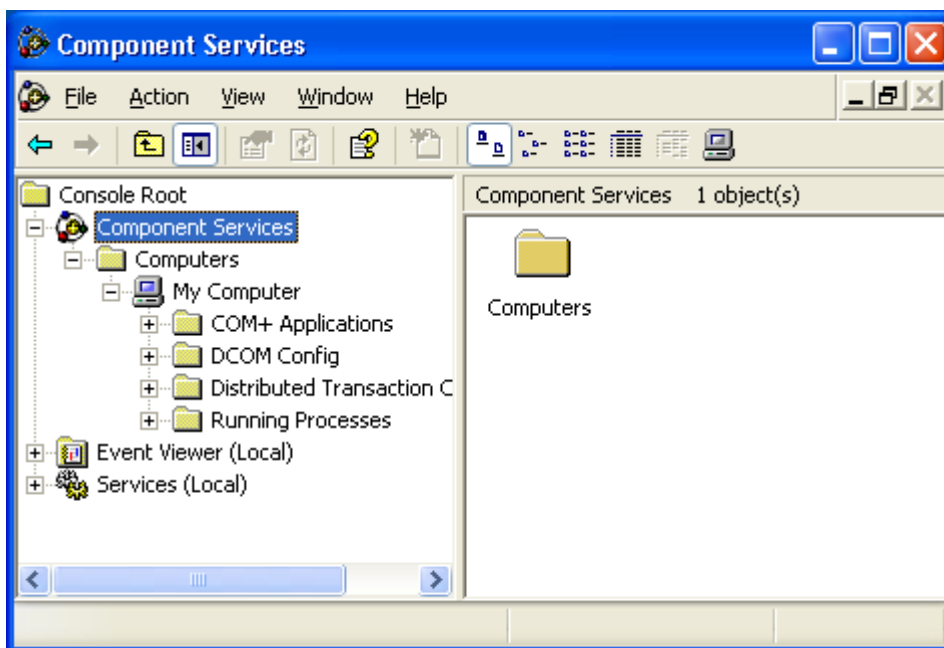

Right-click on **My Computer** and select **Properties**. In the **Default Properties** tab, select the default authentication and impersonation levels. This dialog resembles the `dcomcnfg` interface of Windows NT and 2000, from above.

To set the security and identity properties for **FTSecSvr**, select **DCOM Config** under **My Computer**. The available registered COM applications will be displayed. Scroll and select **FTSecSvr**.

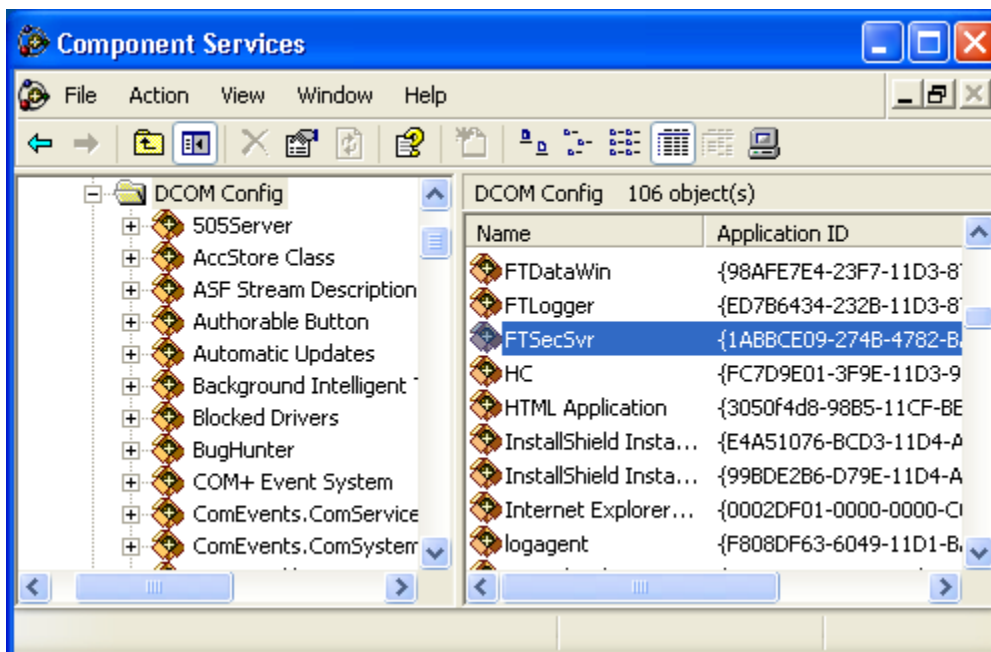

Open its properties by right-clicking on it. The dialog is shown below.

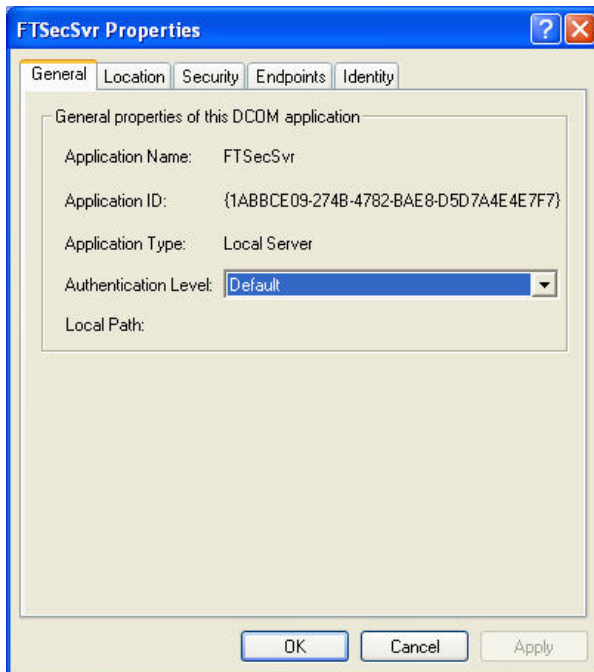

Security Configurator

The Security Configuration Application (**FTSecCfg.exe**) allows users with administrator rights to configure their centralized server based security. This file will reside on the same machine and directory as the server. Users will also be able to install FTSecCfg on client machines running Windows NT (3.1 or later)/2000/XP so that they can configure their security server remotely. The following features are supported.

- Ability to configure which users and/or groups have access to various FasTrak features. This includes users and groups from the machine running the server. Separate secure features will exist for individual FasTrak applications including programming packages as well as ControlShop applications.
- Security Auditing can be configured for each specific feature on an individual or group basis. Audit information will be logged to the **Event Viewer** in the **Security Log** section.
- A link to the Event Viewer will be provided allowing quick access to the Security Log. The event viewer can also be accessed under **Administrative Tools** in **Control Panel**.

Launching the Security Configurator

The Configuration Application may be launched by either clicking the **Start** button in Windows and going to the **Programs** menu or from within WorkShop.

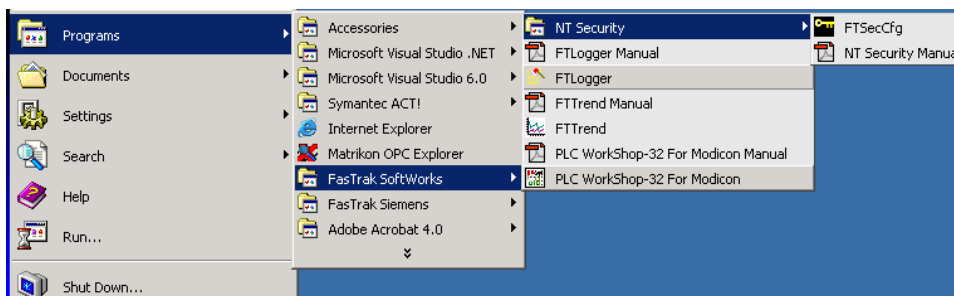

The Security Configurator application will launch and (if the user is not in the client), at the same time, the **Security Server Location** dialog may open. Both are shown below.

When launched from the Start menu, the Security Server Location dialog will prompt the user to select the machine that the server will run on.

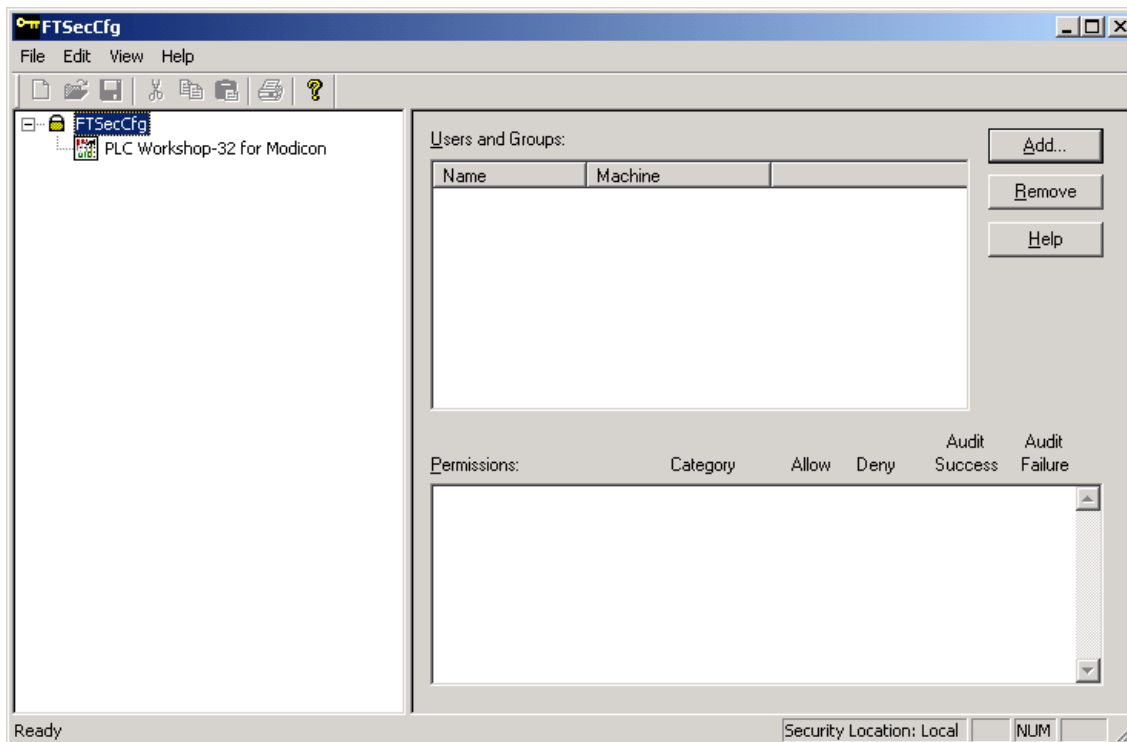

Configuring Users, Groups, and Security Audit

After security has been configured and a server location selected, individual users, groups of users, and permissions may be set from within the **FTSecCfg** utility.

To access the FTSecCfg utility within WorkShop, select the **Options / Security / Administrator Options / Configure** menu item. To access the FTSecCfg utility from the Start menu, select **Start / Programs / FasTrak SoftWorks / NT Security / FTSecCfg**. In either case, the FTSecCfg dialog appears.

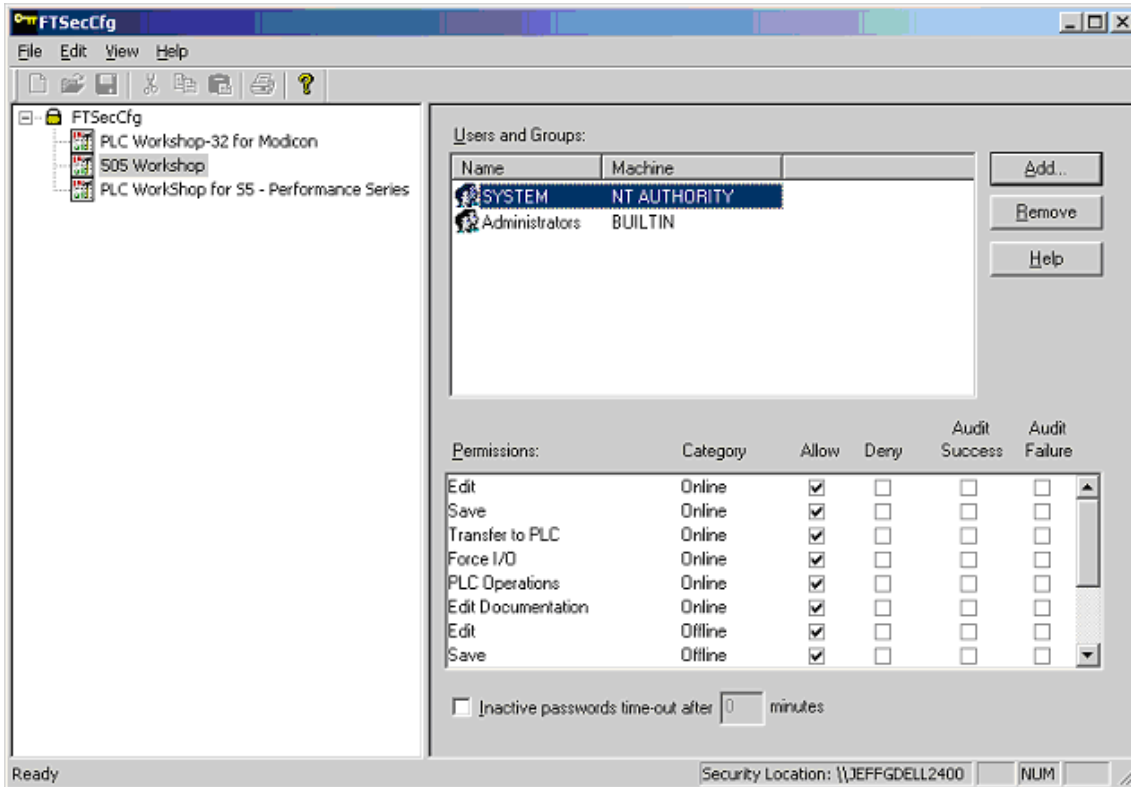

The selected server machine appears in the status bar in the lower right portion of the application window.

In the left pane, the WorkShop application for which the permissions will apply may be selected.

In the **Users and Groups** list box, two names (System and either the administrators group or the current user) will exist by default with access to all features. The list box is sorted with groups listed first followed by users. A group is identified with the two-person icon to the left while the user is identified with the one-person icon. A combination of approximately 16 users and groups can be configured for an application. Users and groups that are not displayed in the list box are automatically denied access to all features.

Adding Users and Groups

To add users and groups:

1. Select **PLC Workshop-32 for Modicon** from the list in the left pane. The users previously added to WorkShop appear in the **Users and Groups** list box.
2. Click the **Add** button.

Removing Users and Groups

To remove a user or group:

1. Select **PLC Workshop-32 for Modicon** from the list in the left pane. The users previously added to WorkShop appear in the **Users and Groups** list box.
2. Highlight a name within the **Users and Groups** list box.
3. Click the **Remove** button.

Setting Permissions

To set permissions for a user or group:

1. Select **PLC Workshop-32 for Modicon** from the list in the left pane. The users previously added to WorkShop appear in the **Users and Groups** list box.
2. Select the desired user from the **Users and Groups** list box.
3. Within the **Permissions** list box:

Select the applicable Allow check boxes to allow the server to provide access when requested by the client (for example, PLC WorkShop).

Select the applicable Deny check boxes to prevent access by the server when requested by the client.

In cases where a user has conflicting rights on a permission, the denied permission will always take precedence and the user will not be able to access the feature. For example, a user may be allowed access to a specific permission but a group he belongs to is denied access to the same permission. If neither box is checked, the user will not be granted access to the feature unless one of the groups he belongs to has access to the feature.

Setting Inactivity Timeout

To set the inactivity timeout for a user:

1. Select **PLC Workshop-32 for Modicon** from the list in the left pane. The users previously added to WorkShop appear in the **Users and Groups** list box.
2. Select the desired user from the **Users and Groups** list box. The user's security privileges appear in the **Permissions** list box.
3. Click the **Inactive passwords timeout after** check box beneath the **Permissions** list box to enable the **minutes** edit box.
4. Enter the number of minutes WorkShop may remain inactive before the user must re-enter his Windows user name and password. The inactive timeout period may range from 1 to 999 minutes.

NOTE: A user is not required to re-enter his Windows user name and password as long as password protected activity occurs in WorkShop within the timeout period.

Security Audits

Security audits for individual features can be performed on users and groups. These audits will appear in the security log on the server machine and can be accessed using Microsoft's Event Viewer. (See *Event Viewer* for more details.) A **Success** audit will appear in the security log when a user is given access to a secure feature, and the **Audit Success** box is checked for that feature. A **Failure** audit will appear in the security log when a user is denied access to a secure feature, and the **Audit Failure** box is checked for that feature.

To perform a security audit on a user or group for an individual feature:

1. Select **PLC Workshop-32 for Modicon** from the list in the left pane. The users previously added to WorkShop appear in the **Users and Groups** list box.
2. Select the desired user from the **Users and Groups** list box.
3. Within the **Permissions** list box:

Select the applicable Audit Success check boxes to enable Success Audits for the selected features.

Select the applicable Audit Failure check boxes to enable Failure Audits for the selected features.

NOTE: All security changes in FTSecCfg are accumulated and do not get committed to the server until confirmation upon exit of FTSecCfg.

Event Viewer

The Event viewer is a Windows application for displaying application, security, and system logs. FasTrak uses and writes to this log to hold audits. It is launched from within the **Security Configurator**.

To launch the Event Viewer, select the **View / Event Viewer** menu item as illustrated below. The Event Viewer is also accessible from the **Administrative Tools** of the Windows **Control Panel**.

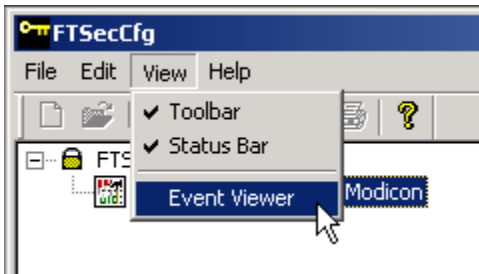

The following window opens. Double-clicking an entry in the right-most pane above will display more information for the item.

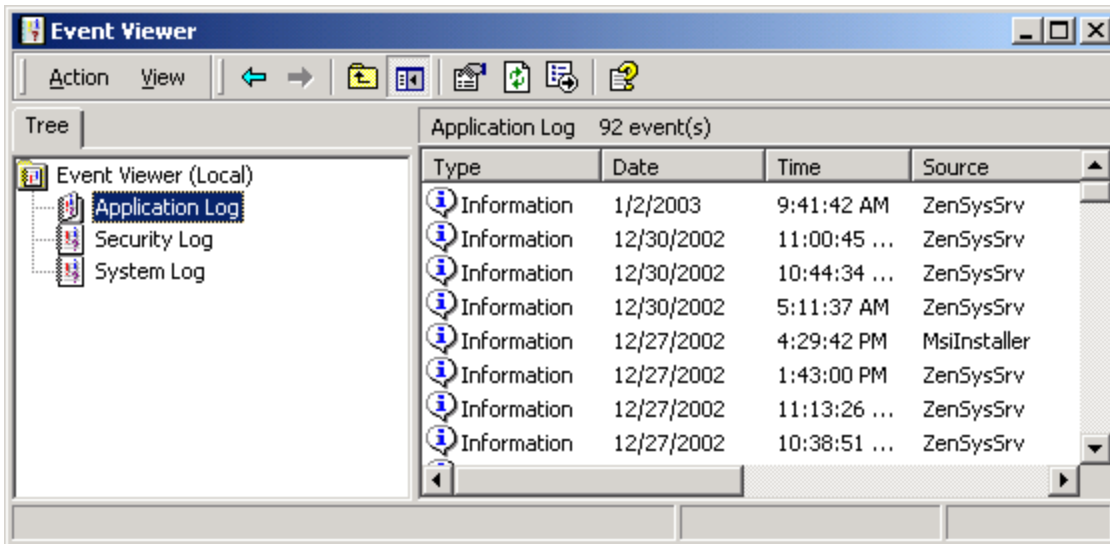

From this application, the user may view the Security log. If running the Security Configurator from a different machine than the security server (FTSecSvr), then the security server's machine name must be specified in the event viewer to view the security log entries referring to FasTrak security. This can be accomplished by highlighting the **Event Viewer** in the tree control and then selecting the **Action / Connect to another computer** menu item as illustrated below.

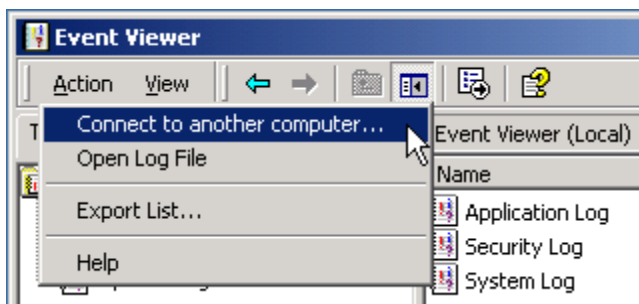

The **Select Computer** dialog appears.

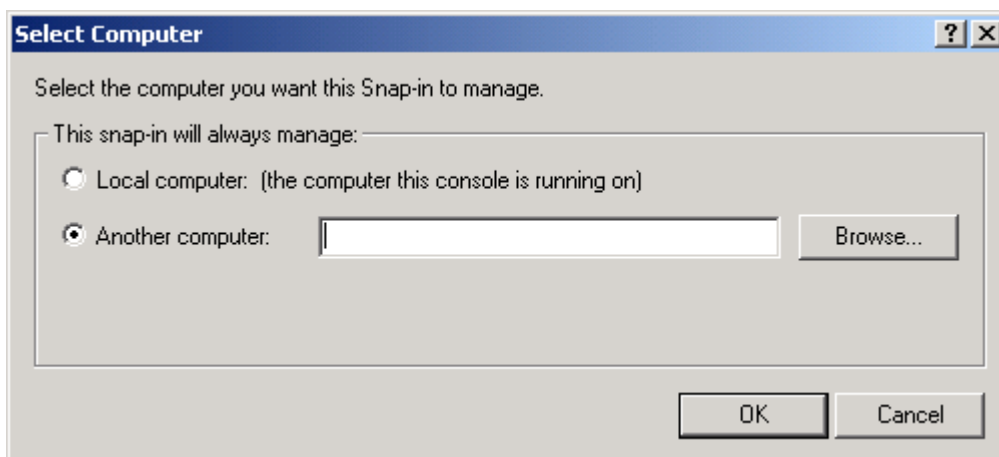

Use the **Browse** button for searching for and selecting another computer.

Click **OK** to accept the selection.

6 - PLC Configuration

Overview

This chapter outlines how the Modicon PLC is set up and configured. The PLC must be configured before ladder logic programs can be created. Configuration is part of the program; it performs the important function of relating the hardware components to the logic components.

The setup and configuration process is completed in two steps in recommended order:

PLC Type Setup: Available in offline mode only, PLC Type Setup allows the specific Modicon processor for which a logic program is being created / edited to be selected.

Options include:

- PLC Type
- Memory Size
- Other options depending on PLC type

PLC Configuration: Configuration is the process in which PLC system components, such as the number of segments, drops, ASCII ports, and I/O modules, are assigned. The locations of modules in the racks are specified and addresses are assigned to the modules. The configuration information is saved along with the ladder program. Configuration options include:

- Configuration screen options
- Modbus Ports
- ASCII Ports
- Traffic Cop
- Configuration Extensions
- Loadables
- Set Clock

PLC Type Setup

The setup and configuration process begins with PLC Type Setup. The PLC must be configured before ladder logic programs can be created.

To set up the PLC for a new program:

1. Select the **File / New** menu item or click the  toolbar icon. The **PLC Type Setup** dialog appears.

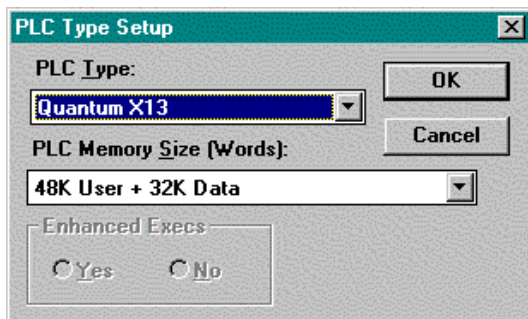

2. Select the appropriate **PLC Type**, **PLC Memory Size**, and for some models, **Enhanced Execs** and **484 Emulation**.
3. Click **OK** or press [Enter] to save your settings and return to the active logic program.

Changing PLC Types

You can change PLC types after you begin programming.

To change PLC type for an existing program, select the **PLC Utilities / PLC Type Setup** menu item. The **PLC Type Setup** dialog appears.

NOTE: Various error or warning messages can occur if changing the PLC type would cause program or configuration information to be truncated or incorrect.

PLC Configuration

The next step is to tell PLC WORKSHOP which PLC to connect to. The next pages describe the configuration procedures for the Modicon 984 family processors. It is suggested that the PLC be configured in the following order:

1. Configuration screen options
2. Modbus Ports
3. ASCII Ports
4. Traffic Cop
5. Configuration Extensions
6. Loadables
7. Set Clock

Some of configuration options listed above are not available or necessary for all processors. The configuration for your 984-family PLC is detailed in the pages following.

PLC configuration can be completed online or offline. However, if the processor is in **Run** mode, stop the processor before you begin online configuration.

While online, accessing the Configuration screen will display the processor's current configuration. Offline the Configuration screen is used to configure the system for programming the logic program.

The Configuration screen is divided into several areas, including:

- Processor
- Configured Quantities
- ASCII
- Miscellaneous
- PLC Clock and Calendar
- Option buttons

All or some of the areas listed above may appear on your configuration screen. Which options appear is dependent of which processor you selected in the **PLC Type Setup** earlier in this chapter. The option buttons displayed on the right side of the Configuration screen also depend on which processor is selected.

EEPROM / Flash Memory

Certain Modicon processors support the use of either EEPROM or Flash memory for the loading or storing of a PLC's operating program. When a PLC receives power, it first checks for a valid memory configuration. If none is found, the controller will then load the contents from either EEPROM or Flash memory. The list below specifies which PLCs are supported.

984 Compacts: A141, 145, A145, 120, A120, A13X, 130, E241, E245, E251, E255

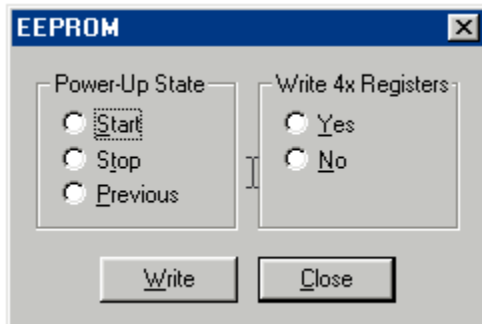

984 Micros: 311, 411, 512, 612

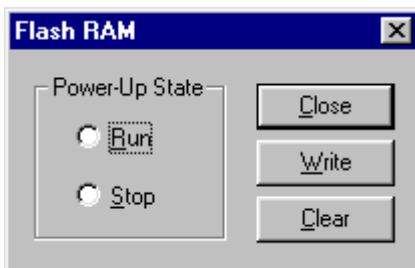

984 Momentums: M1, M1 Mag.

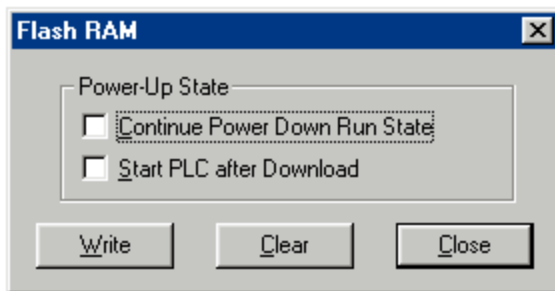

984 32-bit Compacts: E258/E275, E265, E285

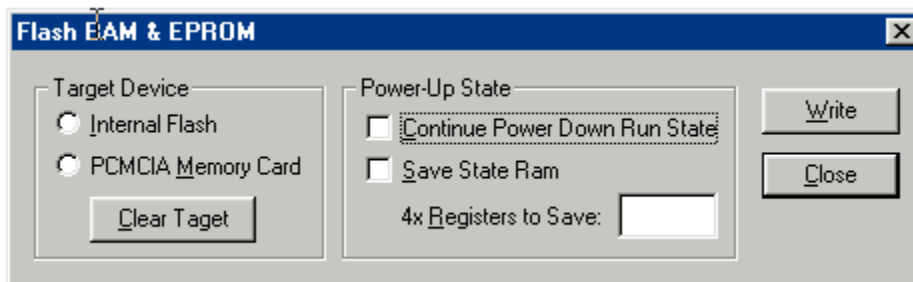

NOTE: The Quantum 434/534 is not supported.

NOTE: The ability to back up user memory by writing it to Flash RAM is a standard feature of all Micro PLCs, except the 612-04. Because of limitations of Flash storage capabilities in 612-04, a battery is the only method available to backup user memory. Memory backed up in Flash remains completely volatile over time.

Depending on the current processor, the following dialog windows will be available. This window displays when selected from the **PLC Utilities** menu and choosing **PLC Operations**. The menu option will not be available when the PLC is in **Run** mode. The dialog allows for the selection of the power-up state and the selection of whether 4x registers should be written (depending on chosen processor type).

NOTE: 32-bit Modicon Compact PLCs can have retries on clearing or writing of EEPROM.

Error Messages

When the pushbutton is pressed from the dialog, an attempt is made to write to the PLC. A number of conditions may generate errors at this point. (See the **GS-COMMS for Modicon - Compact** specification entitled **EEPROM Support** for more details on each error.

No EEPROM card is detected in the PLC slot.

Processor is in Optimize mode. Cannot write to EEPROM.

Attempt to write to EEPROM was unsuccessful.

Cannot modify EEPROM. Power must be cycled.

Processor error. Cannot write to EEPROM.

Control is returned to the PLC Operations window when any of these errors is cleared.

Flash RAM

The **Flash RAM** pushbutton is displayed whenever supported by the current processor. Pressing the Flash RAM pushbutton on the PLC Operations Window displays a dialog box allowing the power-up state of the Flash RAM program. The Flash RAM pushbutton is grayed if the processor is in RUN mode. (See fig. 6.1b)

The default value for power-up state is **Run**.

Configuring the Modicon 984 Family Processors

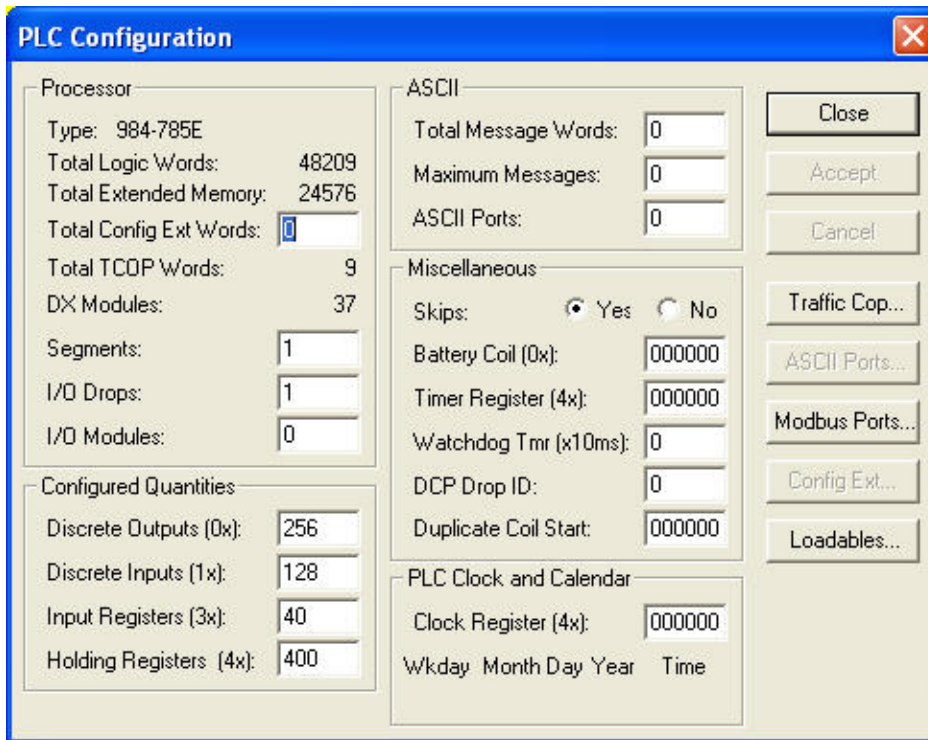

The PLC Configuration dialog box on your screen may be different than the example above. However, many of the configuration options are the same. Following is a listing of PLC Configuration dialog box options for all processors.

Screen Area	Description
Processor	
<i>Type</i>	Displays the type of processor selected. See PLC Type Setup in this chapter.
<i>Total Logic Words</i>	Displays the total number of words that are available for logic programming. The number is set automatically and is dependent on the PLC type and size selected in PLC Type Setup. You cannot change this value.
<i>Total Config. Ext. Words</i>	Allows an area for options available under Configuration Extensions.

<i>Total TCOP Words</i>	Displays the number of memory words assigned to the Traffic Cop. Can be configured for Quantum, Momentum, and 32-bit Compact PLCs.
<i>DX Modules</i>	Displays the number of modules available for Data Transfer options. You cannot change this value.
<i>Segments</i>	Enter the number of segments.
<i>I/O Drops</i>	Enter the number of I/O Drops to be configured within Traffic Cop . The maximum number is dependent on the PLC Type and the number of Segments set above.
<i>I/O Modules</i>	Enter the number of I/O Modules to be configured within Traffic Cop. The maximum number is 32 times the number of I/O Drops. However, for 984-48x processors the maximum number is 21 in the first drop and 32 thereafter.
<i>Channels</i> <i>984A-S901, 984B-S901 processors only</i>	Enter the number, of I/O channels, available to the program. The value must be an even number between 2 and 16.
Configured Quantities	
<i>Discrete Outputs (0x)</i>	Enter the number of logic coils available for the program. The number must be divisible by 16 with the maximum number dependent on PLC type and state table size.
<i>Discrete Inputs (1x)</i>	Enter the number of discrete inputs available to the program. The number must be divisible by 16 with the maximum number dependent on PLC type and

<i>Input Registers (3x)</i>	state table size. Enter the number of input registers available to the program. The maximum number is dependent on PLC type and state table size.
<i>Holding Registers (4x)</i>	Enter the number of output/holding registers available to the program. The maximum number is dependent on PLC type and size.
ASCII	
<i>Total Message Words</i>	Enter the number of memory words to set aside for ASCII message storage. The value is dependent on PLC size.
<i>Maximum Messages</i>	Enter the number of ASCII messages to be stored in memory. The number varies depending on PLC type and memory.
<i>ASCII Ports</i>	Enter the number, between 0 and 32, of RS-232C ports. There are remote I/O ports included in the system for ASCII communications. There are two ASCII ports for each configured I/O Remote Drop. Configure the Traffic Cop before you configure the ASCII Ports by clicking the ASCII Ports option button. See ASCII Port configuration later in this chapter.
<i>ASCII Output (4x) 984A and 984B series processors only</i>	Enter a reference number for the holding register (4x). This number indicates the first register of a group of 32 registers reserved for simple ASCII. The first register is the control register.
<i>ASCII Input (4x)</i>	Enter a reference number for a simple ASCII holding register (4x).

Miscellaneous*

Skips

Select Yes if the Skip instruction is permitted in the logic program.

Battery Coil

Enter the location of the battery coil through the reference number (0x). When this coil is used in a ladder logic program, it reflects the status of the battery back-up system. A zero setting indicates no battery coil is available.

Timer Register (4x)

Enter the location of the timer register through the reference number (4x). This is a holding register set aside to hold the number of 10 millisecond clock cycles. A zero setting indicates no timer registers are available.

Watchdog Tmr (x10ms)

A zero (0) setting equals 250 milliseconds—the maximum value. Enter values between 1 and 25. That value is the number of milliseconds times 10. For example, if you enter 8, the number of milliseconds is 80.

DCP Drop ID

Enter a drop number when the processor is part of a D908 distributed control system. This option is available only for those processors that can act as drops in a DCP system. The value must be between 0 and 32; zero indicates no DCP Drop.

PLC Clock and Calendar

Clock Register (4x)

Enter the location of the time of day clock through a reference number (4x). The clock uses 8 registers, 7 + the one register you specify.

*Month, Day, Year,
Hour, Min., Sec*

A zero setting indicates no clock registers are available.

Displays the PLC's current date and time

***Additional Miscellaneous section options for B984-100 and B984-102 processors only**

Module Type	Select either B884 or B886.
Input	Select Latched or Unlatched.
Group 1	Enter a value from 0 to 99.
Group 2	Enter a value from 0 to 99.
Group 3	Enter a value from 0 to 99.
Group 4	Enter a value from 0 to 99.

Modbus Ports

Continue configuring your PLC by completing the configuration of the Modbus ports.

To access the Modbus port configuration:

1. Click **Modbus Ports** in the **PLC Configuration** dialog box. The **Modbus Ports** dialog box appears.

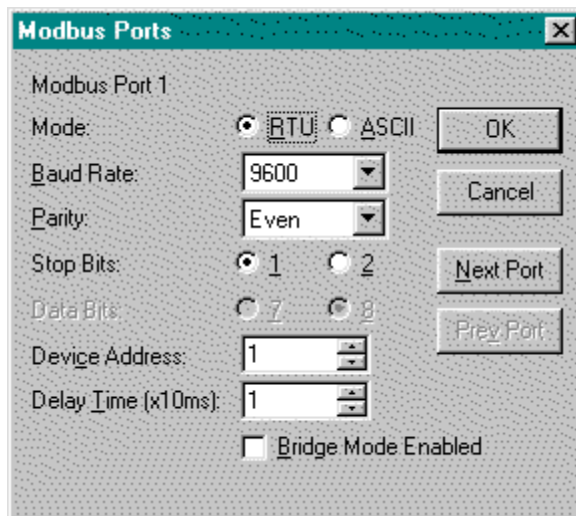

2. Select the appropriate settings for each port.
3. Move from port to port by clicking the **Next Port** or **Prev Port** buttons.
4. Save changes to all ports by clicking **OK**. To disregard changes and return to the PLC Configuration dialog box, click **Cancel**.

NOTE: You are unable to enter values in **Device Address** and **Delay Time** when **ASCII** mode is selected.

ASCII Ports

After you have completed configuration of the **Traffic Cop**, the next step is to configure the ASCII ports. However, some processors do not support ASCII messages. If you do not see the **ASCII Ports** button on the right side of your **PLC Configuration** dialog box, your processor does not support ASCII messages.

To access the **ASCII Ports** dialog box:

1. Click **ASCII Ports** in the **PLC Configuration** dialog box. The **ASCII Ports** dialog box appears.

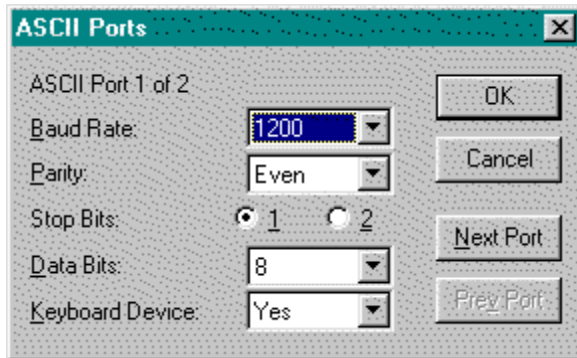

2. Select the appropriate settings for each port.
3. Move from port to port by clicking the **Next Port** or **Prev Port** buttons.
4. Save changes to all ports by clicking **OK**. To disregard changes and return to the PLC Configuration dialog box, click **Cancel**.

Default settings for each port are:

Baud Rate: 1200

Parity: Even

Stop Bits: 1

Data Bits: 8

Keyboard Device: Yes

Micro Modbus Ports

The Modbus ports for Micro-984 controllers are configured using the **PLC Configuration** dialog found under the **PLC Utilities** menu.

Depending upon the chosen mode (**Single, Parent, or Child**), the **Ports Configuration** will change. This configuration as well as the communication setup for the ports is accessible by click on the **Modbus Ports** dialog button. The following window opens.

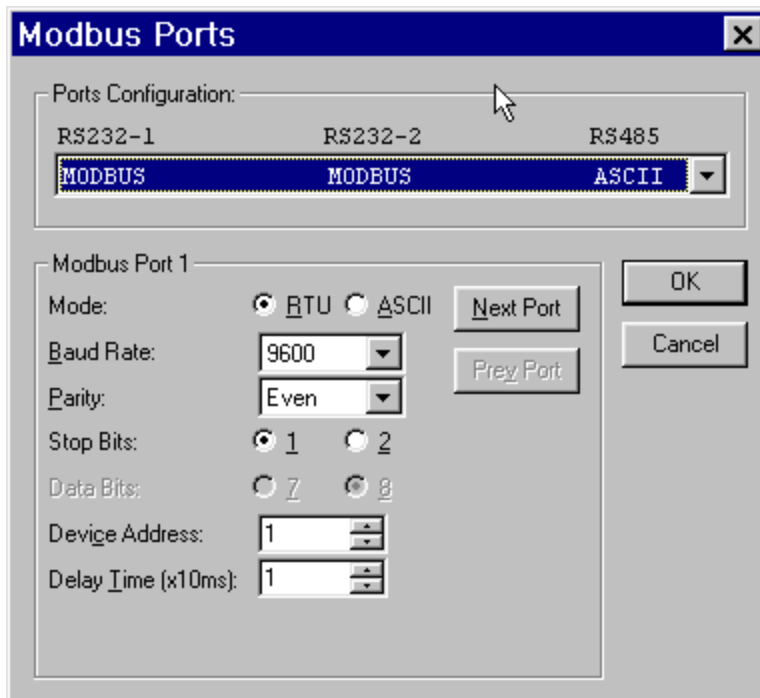

The combo box in the window's upper half can be expanded by using the drop-down button. Toggling between available ports is done by clicking on the **Next Port** and **Prev Port** button. To accept the changes made, click on **OK**; to quit without saving changes, click **Cancel**.

The port configuration information is included when the Configuration is printed. For more information on printing the configuration, see *Print PLC Configuration*.

NOTE: The Port configuration always displays the second port even if it does not exist for a PLC.

Supported PLC types include: 311/00, 01, 02, 03; 411/00, 01, 02, 03; 512/00, 01, 02, 03; 612/00, 03, 04

Traffic Cop

Every PLC system will have a certain number of inputs and outputs, whether they be Discrete (on/off) or Analog. Each physical input and output is wired to a terminal on an I/O module. This module may only be a small part of a series of I/O that must all work together within the same environment and parameters. Some of these modules may be attached directly to the main PLC rack (local I/O), while others may be located elsewhere (remote I/O).

The PLC must be able to recognize and manage the various I/O and direct the flow of data between the physical connection points and the logic program. The **Traffic Cop** is the link between the references used in the logic program and the physical I/O.

Once Modbus Ports settings are completed, configuring Traffic Cop is the next step in PLC Configuration. Here you may reconcile the physical parameters of your various I/O modules and your PLC.

This diagram illustrates the Traffic Cop configuration process.

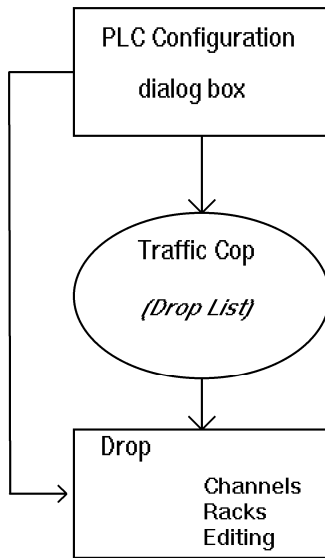

The Traffic Cop organizes I/O into groups, called drops (or channels, depending on the PLC Type). A drop can be multiple racks of remote I/O, which must be managed by the Segment Scheduler to be scanned, or it can be a single module on the local rack. Each drop contains a certain number of slots, which are single instances of input or output and contain specific I/O modules.

Every I/O module belongs to a certain family of Modicon I/O. There are several families of Modicon I/O available; each I/O family has its own Traffic Cop. The Traffic Cop you see will depend most upon the PLC Type selected.

Configuring Traffic Cop for 800 Series I/O

Before configuring Traffic Cop, verify that the settings within the **PLC Configuration** dialog are correct. Configure **I/O Drops** and **Modules** (and **Total TCOP Words** for Quantum, Momentum, and 32-bit Compact PLCs) within PLC Configuration to reflect the hardware to be configured and define the size of the Traffic Cop within the program. These settings, along with the **PLC Type**, will determine what information you will see when configuring Traffic Cop.

To access the Traffic Cop, click the **Traffic Cop** button on the left side of the **PLC Configuration** dialog box. If your processor supports Remote I/O, the **Traffic Cop** dialog appears.

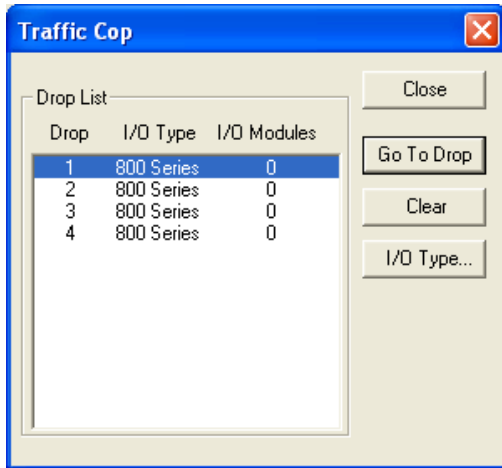

The above dialog shows that four drops have been configured for this PLC. This information was entered in the **PLC Configuration** dialog into the **I/O Drop** text box. If more than one drop can be configured, the first drop will always contain the local I/O. Subsequent drops can contain Remote I/O.

Certain PLC processors can support Remote I/O from different families. To see what families of I/O your processor supports, click the **I/O Type** button. In this instance, the processor only supports 800 Series I/O.

To edit the I/O within a specific drop, click **Go To Drop**. The **I/O Drop Editor** appears.

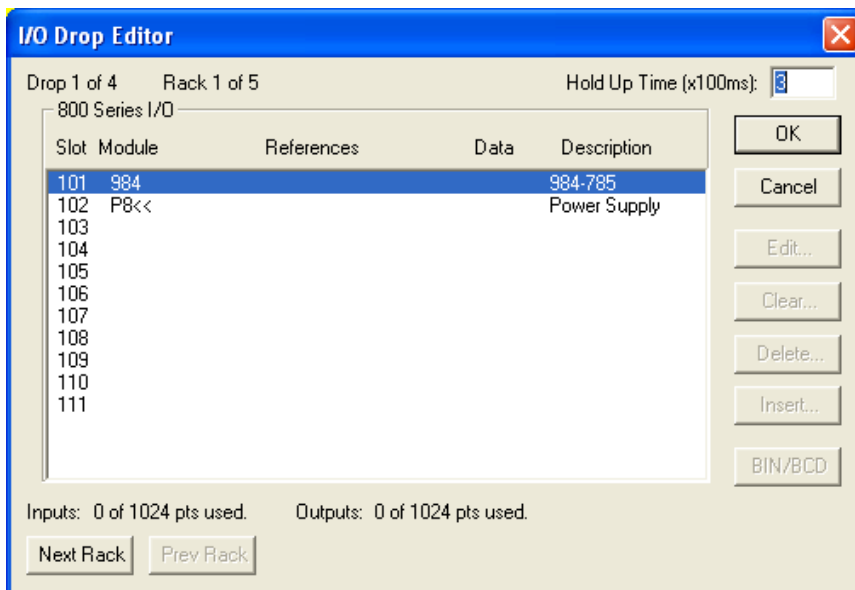

The above dialog displays the I/O information for the first rack (of five) within the first drop (of four). Notice that Slot 101 and 102 are already filled. Since this drop represents the local I/O, the PLC and its power supply are present on the first rack. As these two slots do not contain I/O, they cannot be edited.

Add I/O to an empty slot by selecting a slot and clicking the **Edit** button. The **Edit** dialog appears.

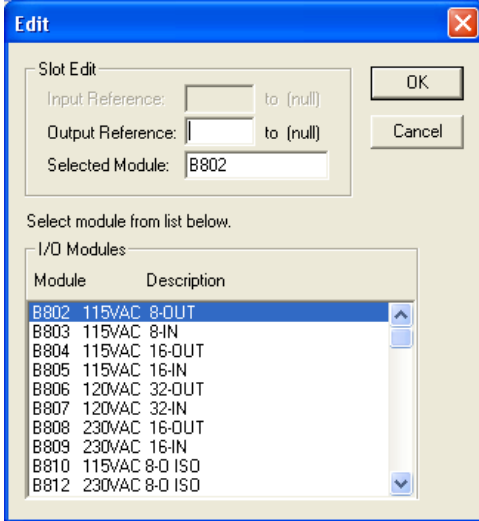

From here you can select the appropriate I/O module by typing the module number in the **Selected Module** text box or selecting it from the comprehensive list. Depending on whether the module is an input or an output, the **Input** or **Output Reference** text box will be activated. Type the appropriate register reference within the text box.

The following table illustrates the different register types and their associations.

	Input	Output
Discrete	1x	0x
Analog	3x	4x

Click **OK** when finished. The **I/O Drop Editor** appears with the newly configured module.

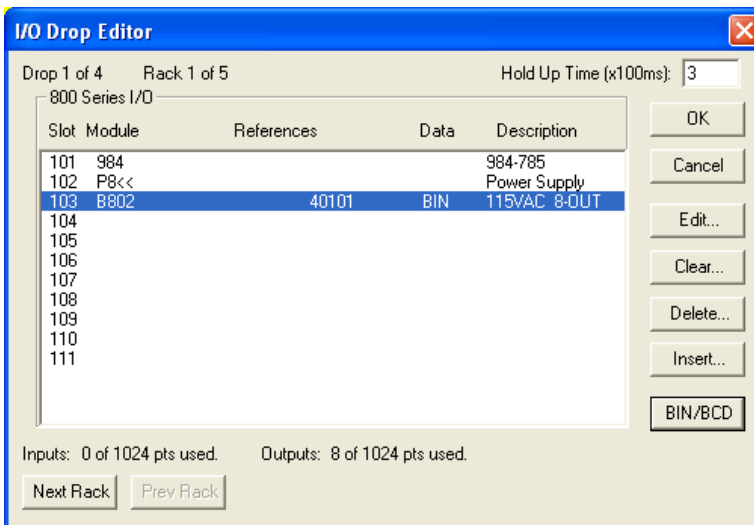

In this instance an output was configured for slot 103. Continue configuring the I/O until they are properly represented within Traffic Cop. Further configuration options within Traffic Cop follow.

- Click the **Clear** button to remove an I/O module from the selected slot. In some PLCs, slots and racks can be added and removed manually to fully represent the user's hardware configuration. For these users, clicking **Delete** will completely remove a slot or rack and its contents. Clicking **Insert** allows you to add a new slot or rack to the drop.
- Analog I/O can be set to one of two data formats, either Binary (BIN) or Binary Coded Decimal (BCD). Click the **BIN/BCD** button to toggle between the two.
- **Hold Up Time** represents the number of seconds the selected I/O drop will hold its values if communication from the PLC is lost. The default is three seconds.
- To browse another rack within the same drop, click the **Next Rack** and **Prev Rack** buttons to navigate to the rack you want to view.

Click **OK** to return to the **Traffic Cop** dialog.

To configure the **Remote I/O**, select the next drop in the **Drop List** within the **Traffic Cop** dialog and click the **Go To Drop** button. The I/O Drop Editor appears displaying the remote I/O drop.

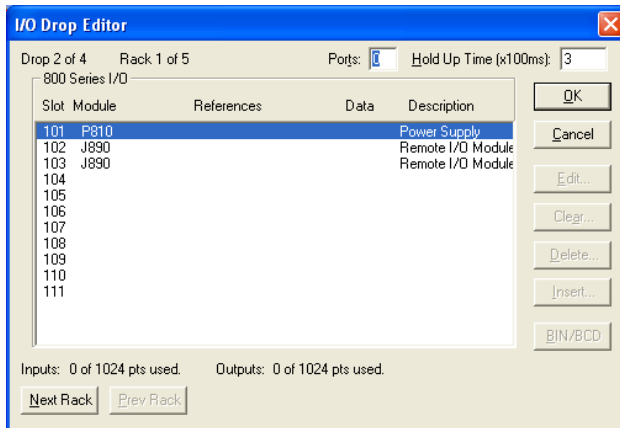

Listed above are the default modules for an 800 Series remote I/O drop. Though it appears that the first three slots are taken by the default modules, only Slot 101 is unavailable for configuration. Select either J890 module and click **Edit** to modify the module. Once the module has been configured, the **I/O Drop Editor** dialog appears.

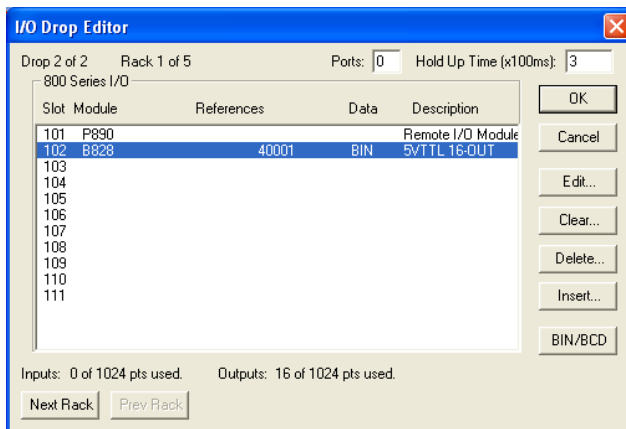

The default modules are now confined to one slot.

Module Status

While online, Traffic Cop recognizes correctly and incorrectly configured I/O modules based on the actual hardware that is connected to the PLC. When the PLC is not running (Stop Mode) module status may be viewed in the **I/O Drop Editor**.

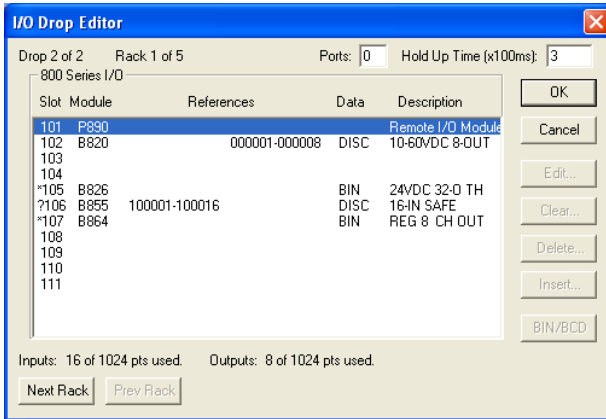

Incorrectly configured modules will appear with an asterisk (*) or a question mark (?) directly preceding the slot number. An asterisk signifies that while the module is physically present, is has not been configured with address references. A question mark signifies that either the module is not configured correctly, or is not physically present.

Module health can also be viewed from the **PLC Status** dialog. See **Module Health** for more information.

Configure each I/O drop as above until all I/O have been entered into Traffic Cop, including modules that work with **Configuration Extensions**, such as **Profibus**. When you are finished, click **Close** in the **Traffic Cop** dialog to return to the **PLC Configuration** dialog.

Square D-SY/MAX TCOP Modules

The following SY/MAX modules and their descriptions are supported in Modicon WorkShop. These modules are found in the Traffic Cop dialog window from within PLC Configuration.

Module	Description
CRM931 DG1	Digital 1 Register Rack S908 Interface
CRM931 DG2	Digital 2 Register Rack S908 Interface
CRM931 DG4	Digital 4 Register Rack S908 Interface
CRM931 DG8	Digital 8 Register Rack S908 Interface
CRM931 RG	Register Rack S908 Interface
RIM101/361	16 Point Input 120/240V AC/DC
RIM121/125	4/16 Point Input Analog
RIM123	8 Point Input High Speed Analog
RIM126	8 Point Input Analog Thermocouple

RIM127	12 Point Input RTD
RIM131	High Speed Counter
RIM144	Multiplexed Input BCD
RIM301	16 Point Input 85-140V AC
RIM331	32 Point Input 24V DC
RIM731	64 Point Input 24V AC/DC
ROM121	4 Point Output Analog
ROM122	4 Point Output Analog Isolated
ROM131	Stepper Motor Controller
ROM141	Multiplexed Output BCD
ROM221/431	16 Point Output 120/240V AC
ROM271	16 Point Output Relay 120V AC
ROM421	16 Point Output 35-140V AC
ROM441	32 Point Output 24V DC
ROM871	64 Point Output Reed Relay
SIM116	16 Point Input Simulator
RDI 16 - 32□	Symax RDI
RD0 8 - 64□	Symax RD0
RDI x32□	Symax RDI 32
RIO 224□	Symax RIO 224

A new drop must first be added to the Traffic Cop prior to selecting I/O type and specific module names. From the **Traffic Cop** dialog, choose **Insert** for the **Insert Drop** dialog.

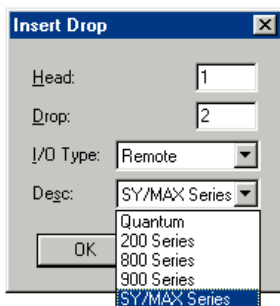

Enter values for both the **Head** and **Drop** fields as well as selecting **I/O Type Remote** and **SY/MAX Series** as the description.

The entry will be added to the Traffic Cop dialog as seen below. The new entry may be selected for editing by clicking on it once.

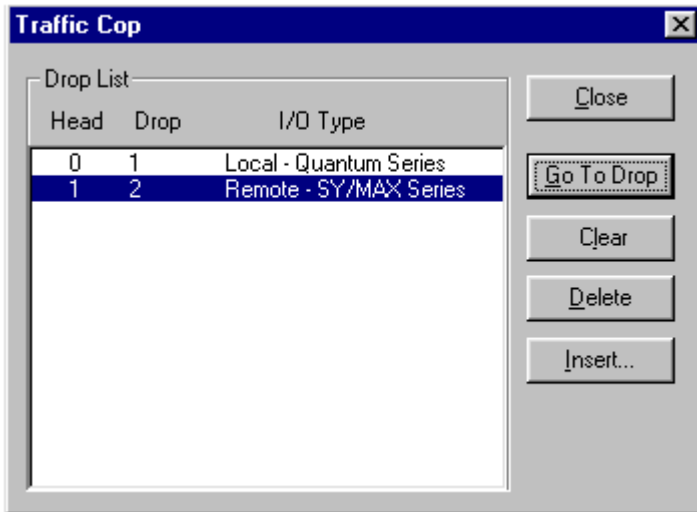

Once selected, click on **Go To Drop** and the **I/O Drop Editor** dialog opens. Highlight the desired slot by clicking in it once, then choose **Edit** from the buttons to the right, as seen in the figure below.

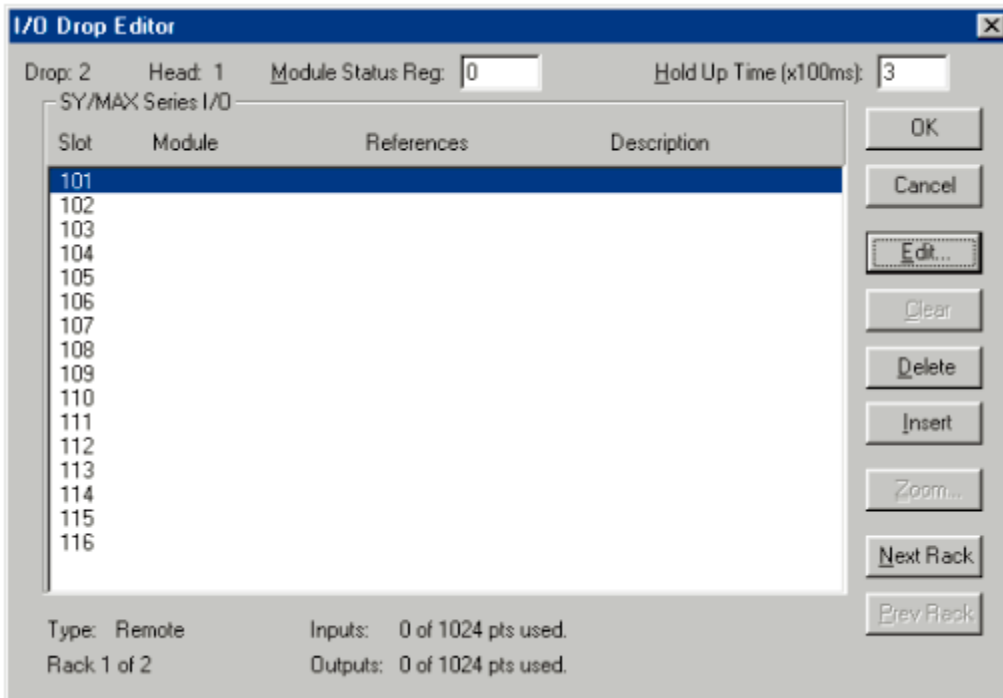

Highlight the desired module by clicking on it once and enter valid addresses in the available fields.

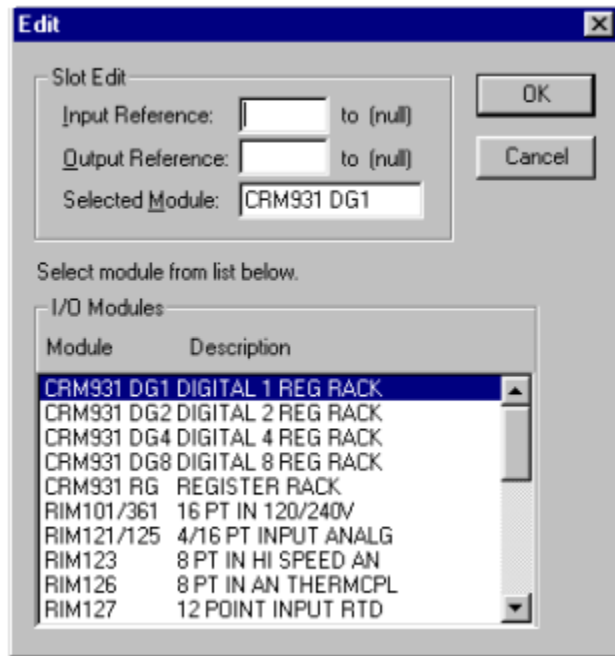

NOTE: The following table is used for determining which physical module is under the TCOP configured module. The Superset of registers has been utilized and, therefore, unused registers will be configured.

RDI 16 - 32	RD0 8 - 64	RDI x32	RIO 224
RDI-016	RD0-408	RDI-316	RI0-244
RDI-032	RD0-508	RDI-332	
RDI-116	RD0-564	RDI-432	
RDI-132	RD0-616/716/816	RII-x16	
RDI-164	RD0-732		
RDI-216			
RDI-x16			
RTS-216			
RTS-212			

Configuration Extensions

So far you have completed the **PLC Configuration** dialog box settings, **Traffic Cop** configuration, **ASCII Ports** configuration, if supported, and **Modbus** configuration. The next step is to setup up the **Configuration Extensions**.

However, you must enter a value greater than zero (0) in the **Total Config. Ext. Words** in the **PLC Configuration** dialog box for the **Config Ext.** button to be an option. The Configuration Extensions include:

Data Protection: Prevents discrete outputs(0x) and holding registers(4x) from being overwritten.

Peer Cop: Configures transfer of data between controllers on a Modbus Plus network.

S980 Station Address: Specifies the S980 Address (in hex format).

TSX QTM VME Sys Ctrl: Configures transfer of data between Quantum master/slave elements.

Quantum Hot Standby: Configures Hot Standby feature installed on select Quantum controllers.

TCP/IP Setup: Configures the controller to connect to a network through a TCP/IP connection.

SY/MAX ENET Setup: Configures SY/MAX RIO cards to operate with select Quantum controllers.

MMS ENET Setup: Configures Quantum controllers to connect through an MMS Ethernet module.

I/O Scanner Setup: Configures transfer of data between controllers on a TCP/IP network.

Compact Phase II: Modifies Secure Data Area Size and RTS/CTS Delay.

Profibus: Configures Quantum controllers to connect through a Profibus module.

NOTE: Some Configuration Extensions are not supported by every PLC, and will be unavailable for selection in the Configuration Extensions dialog. Consult your hardware documentation for further information.

To access the Configuration Extensions dialog:

1. With the **PLC Configuration** dialog open, enter a value greater than zero (0) in the **Total Config. Ext. Words** text box.
2. The **Configuration Extensions** dialog appears.

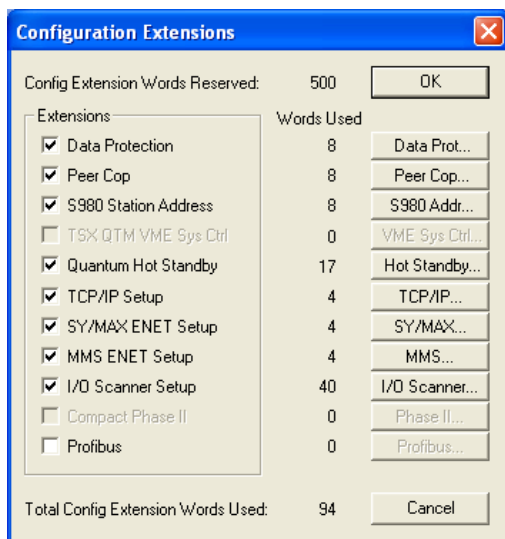

- Choose the Extensions to be activated by selecting the checkbox preceding the available Extension.

NOTE: Each Extension is assigned a word value. The selected Extensions cannot exceed the value entered in the **Total Config. Ext. Words** text box within the **PLC Configuration** dialog. Words used for each selected Extension appear directly to the right of the Extension under the **Words Used** column.

- Selecting an Extension activates the associated button on the right side of the dialog. Click the button to configure the Extension.

Data Protection

This extension is used to protect specific output (0x and 4x) reference data from being overwritten by general data write commands. By default, all 0x and 4x references are unprotected.

To add the Data Protection extension:

- Select the **Data Protection** checkbox in the **Configuration Extensions** dialog. The **Data Prot** button becomes selectable.
- Click the Data Prot button. The parameters for **Data Prot** appear in the **Data Protection** dialog.



- Enter the range of the 0x addresses in need of data protection by typing the starting address in the first box and the ending address in the second box labeled **Discrete Outputs (0x)**.
- Enter the range of the 4x addresses in need of data protection by typing the starting address in the first box and the ending address in the second box labeled **Holding Registers (4x)**.
- Click **OK** to return to the **Configuration Extensions** dialog.

Peer Cop

This extension allows communication between controllers on a peer-to-peer network, and links networks with the S985 (NOM-2xx-00 for Quantum) communication card. Data blocks can be configured to transfer continuously between nodes on a Modbus Plus network. Peer Cop configures Global I/O, which is broadcast to all nodes on a single link or head, or Specific I/O, in which specific Modbus Plus nodes communicate one-on-one within a single link or head.

To add the Peer Cop extension:

1. Select the **Peer Cop** checkbox in the **Configuration Extensions** dialog. The **Peer Cop** setup dialog appears.

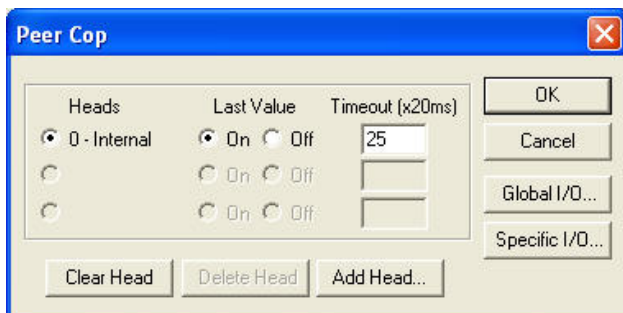

2. The first Head, **0 - Internal** is selected by default. Click **Add Head** to add another head, or configure the current head.
3. The following can be configured for each head:
 - **Last Value/Timeout**
 - **Global I/O**
 - **Specific I/O**

Last Value determines whether or not to hold the last input data value. Select On to leave the input data in its previous state.

Timeout specifies the amount of time a Peer Cop communication must fail before the bit is cleared. The default is 25 X 20 (500)ms.

Global I/O broadcasts a specific range of addresses (Global Output) to many devices (Global Input) over a Modbus Plus Network. There is only one Global Output to configure, but each device to receive the data must be configured as Global Input.

Specific I/O communicates on a one-on-one basis in which a single device accepts an entire data block from a single source. Multiple devices can be configured to send and receive specific blocks of data to and from specific sources. The configured amount of data being sent from a source must be identical to the amount of data a device is configured to accept.

To configure **Global I/O**:

1. Click the **Global I/O** button in the **Peer Cop** dialog. The **Global I/O** dialog appears.

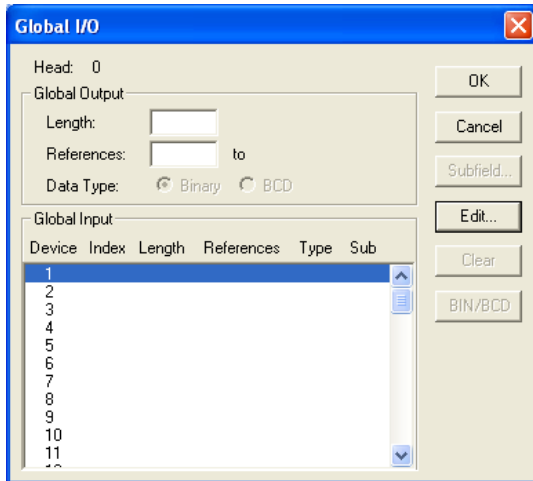

2. To configure the **Global Output**, enter the length of the Global Output address range in the **Length** text box and the starting address of the address range in the **References** box.
3. To configure the **Global Input**, select the device number of the first Global Input and click the **Edit** button. The **Edit** dialog appears.

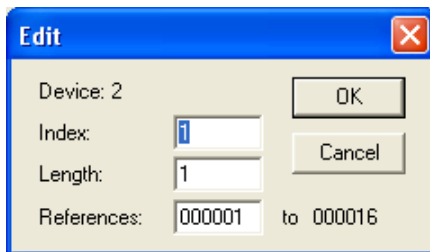

4. Enter the starting point of the data to read (1 to 8) in the **Index** text box.
5. Enter the number of words to read (1 to 32) from the Index value in the **Length** text box.

NOTE: The Index value and Length value cannot equal more than 33.

6. Enter the starting address to store the received data in the **References** text box. Click **OK** when finished to return to the **Global I/O** dialog.
7. Each device also supports the ability to section the data into blocks using **Subfields**. To configure a Subfield for a device, select a configured device and click the **Subfield** button in the **Global I/O** dialog. The **Subfield** dialog appears.

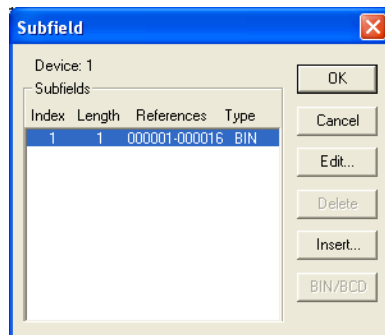

8. Add subfields to a device by clicking the **Insert** button. Configure each subfield in the same manner as the device, by entering Index, Length, and Reference parameters. Click **OK** when finished to return to the **Global I/O** dialog.
9. Configure each **Global Input** as above. Click **OK** in the **Global I/O** dialog when finished to return to the **Peer Cop** dialog.

To configure **Specific I/O**:

1. Click the **Specific I/O** button in the **Peer Cop** dialog. The **Specific I/O** dialog appears.

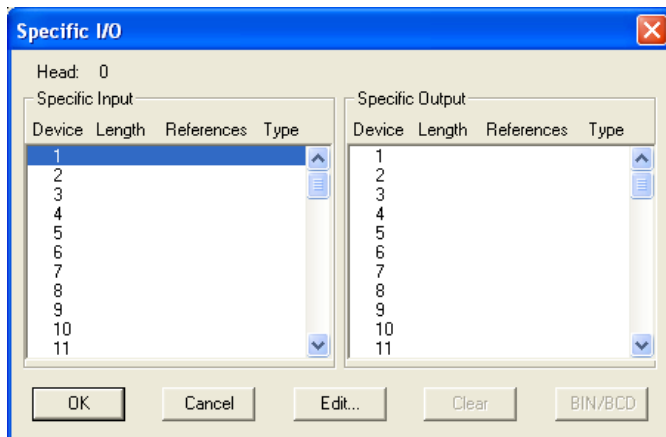

2. To configure the Specific Inputs, select the first **Specific Input** device to configure and click the **Edit** button. The **Edit** dialog appears.

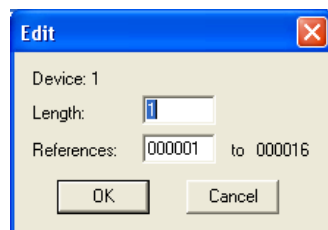

3. Enter the number of words to read (1 to 32) from the Index value in the **Length** text box.
4. Enter the starting address to store the received data in the **References** text box. Click **OK** when finished to return to the **Specific I/O** dialog.
5. Configure each **Specific Input** device as above.
6. To configure the Specific Outputs, select the first **Specific Output** device to configure and click the **Edit** button. The **Edit** dialog appears.
7. Configure each Specific Output device using the same steps as above. Click **OK** in the **Specific I/O** dialog to return to the **Peer Cop** dialog.

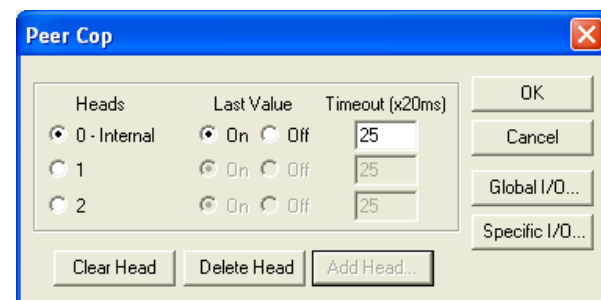

- Click **OK** to return to the **Configuration Extensions** dialog.

S980 Station Address

The S980 Station Address can be specified here to identify the S980 with a specific location.

To add the S980 Station Address extension:

- Click the **S980 Station Address** checkbox in the **Configuration Extensions** dialog. The **S980 Addr** button becomes selectable.
- Select the **S980 Addr** button. The parameters for S980 Addr appear in the **S980 Station Address** dialog.

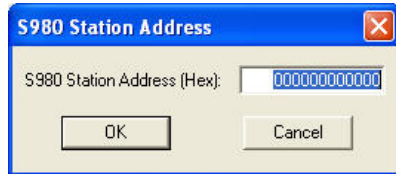

- If this is the first time to use the Extension, the address defaults to **000000000000**, as seen above. Enter the new address.
- Click **OK** to return to the **Configuration Extensions** dialog.

Quantum VME Bus Configuration Extension

The Quantum VME Bus extension lets a VME-424/X card control data transfers between elements of a master/slave

Quantum network. With a master/slave protocol, one element (the “master”) has control over other parts (“slaves”).

As the network runs, each element can lose and gain master status, based on negotiations with other members of the network.

To add the Quantum VME Bus extension:

- Click the **TSX QTM VME Sys Ctrl** box on the **Configuration Extensions** dialog box. The **VME Sys Ctrl** button becomes selectable.
- Select the **VME Sys Ctrl** button. The parameters for **VME Sys Ctrl** appear in the **TSX QTM VME CE Setup** dialog box.

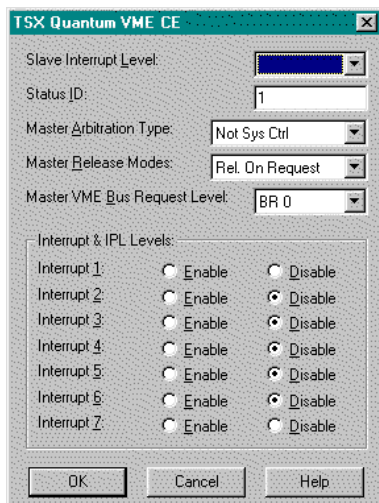

3. In the Slave Interrupt Level field, type the appropriate value. Boards on a VME Bus can send and respond to messages on seven interrupt levels, numbered from 1 to 7. This field determines which interrupt level the board uses when it's acting as a slave.
4. In the Status ID field, type a value between 1 and 255. When the VME controller receives an interrupt while acting as a slave, this is the value it sends.
5. Select an appropriate value for Master Arbitration Type. This setting determines how the controller will operate. Valid settings are Not System Controller, Primary Mode (PRI) or Round Robin Mode (RRS).
6. Select an appropriate value for Master Release Mode. This field determines when a board acting as a master relinquishes its master status. Valid settings are Release on Request (ROR), Release When Done (RWD), Release On Clear (ROC) or Bus Capture and Hold (BCAP).
7. Select the appropriate value for Master VMEBus Request Level. This setting determines what priority the board has when trying to acquire master status. It can range from BR0 (the lowest) to BR3 (the highest).
8. For each interrupt level from Interrupt 1 to Interrupt 7, select whether it should be Enabled or Disabled. These settings will only have an effect when the VME acts as a master. If an interrupt level is enabled, the controller will respond to any messages sent on that interrupt. If an interrupt level is disabled, the controller will ignore them.
9. Click **OK**.

Quantum Hot Standby

The Quantum Hot Standby extension allows additional configuration of the Quantum Hot Standby setup.

This lets you configure the following:

1. Click the **Quantum Hot Standby** box on the **Configuration Extensions** dialog box. The **Hot Standby** button becomes selectable.
2. Select the **Hot Standby** button. The parameters for Hot Standby appear in the **Quantum Hot Standby** dialog box.

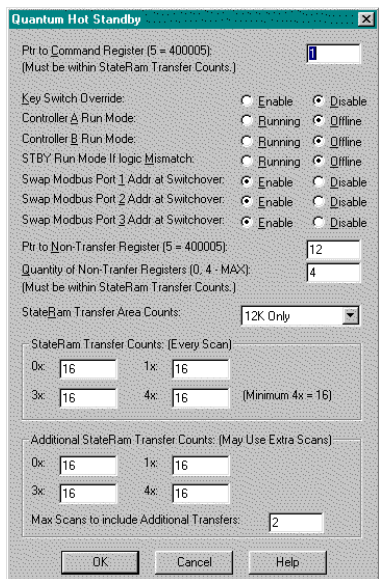

3. In the Command Register Address field, type the 4xxxx address of the command register used to configure the hot standby system. This register must be transferred every scan and cannot be in the non-transfer area. The initial command register contains the settings that are loaded into the controller when it is started. If any changes need to be made while running, the command register must be used, but not the initial command register. Settings such as port address swapping, allowing an executive upgrade, setting the standby's mode on a logic mismatch, setting the controller's modes, and overriding the key switch can be changed from the command register.
4. In the Non-Transfer Start Address field, type the starting address if the range of registers that is not to be transferred from the primary controller to the standby. This is commonly used to reduce scan time. The first two registers are for reverse transfer. These registers allow information to be passed from the standby to the primary controller. The third register is the Status register, which stores the status of both controllers. This register provides information on how the hot standby system is operating, such as the power flow of the CHS instruction, position of the controller's A/B switch, and whether there is a logic mismatch between controllers. All registers following the third register are ignored (not transferred) during the scan.
5. In the Non-Transfer Area Length field, type the length (a minimum of 4 registers to a maximum of total registers configured in the controller) of the non-transfer register range.
6. Select one of the following State Ram Transferred options:
7. Default (12K): All 0xxxx and 1xxxx registers (up to 8192 each) are transferred. If 10000 or fewer 3xxxx and 4xxxx (combined) registers are configured, then all are transferred. If more than 10000 3xxxx and 4xxxx (combined) registers are configured, then (up to) 1000 3xxxx registers and all 4xxxx (up to a combined total of 10000) are transferred.
8. Routine only: All addresses defined in the routine transfer table are transferred every scan. There must be a minimum of 16 4xxxx registers to support the non-transfer area. The Routine Transfer Table is a range of discrete registers that must be configured as a multiple of 16.
9. Routine and Extra: All addresses defined in the routine transfer table and in the extra tables are transferred. The range of each extra table must be a multiple of 16. The extra tables can be transferred over multiple scans.
10. All State RAM: All RAM configured in the controller is transferred every scan.
11. In the Max Scans to Include Additional Transfers field, type the number of scans (1-255) needed for the primary controller to transfer the extra transfer tables to the standby.

Configuring the TCP/IP Extension

The TCP/IP Extension allows a PLC to recognize its TCP/IP communication card. To configure the TCP/IP Extension:

1. Click **TCP/IP Setup** box on the **Configuration Extensions** dialog box. The **TCP/IP** button becomes selectable.
2. Select the **TCP/IP** button. The parameters for **Hot Standby** appear in the **Quantum TCP/IP Setup** dialog box.

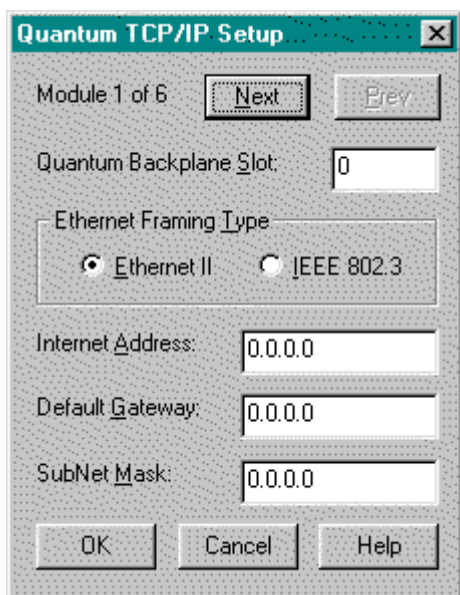

3. Using the **Card Number** field, select a communication card to set up by selecting the **Next** or **Prev** button.

NOTE: Different controllers support different numbers of communication cards: Quantum 113 Rev. 2 and 213 Rev. 2 controllers support two cards, Quantum 424 Rev. 2 supports up to six, and M1E Momentum controllers only support one card and the Head Number is fixed at 1.

4. Type the card's slot number (from 1 through 16) into the Quantum Backplane Slot field. If you do not want to use an installed card, type 0.
5. Select the Framing Protocol your network uses from the Framing Type radio button. Your network administrator determines this protocol when the network is set up.
6. Type the card's TCP/IP address into the Internet Address field. Your network administrator assigns this address.
7. If your network uses one, type the address of the Default Gateway into its field. Your network administrator assigns this address.
8. If your network uses one, type the address of the Sub-Network Mask into its field. Your network administrator assigns this address.
9. Click **OK**.

SY/MAX Configuration Extension

The SY/MAX configuration extension allows you to properly access and configure up to six SY/MAX RIO cards. This extension is only available when using Quantum Rev. 2 or later controllers.

To configure the SY/MAX extension:

1. Click **SY/MAX ENET Setup** box on the **Configuration Extensions** dialog box. The **SY/MAX** button becomes selectable.
2. Select the **SY/MAX** button. The parameters for SY/MAX ENET appear in the **Quantum SY/MAX Ethernet Setup** dialog box.

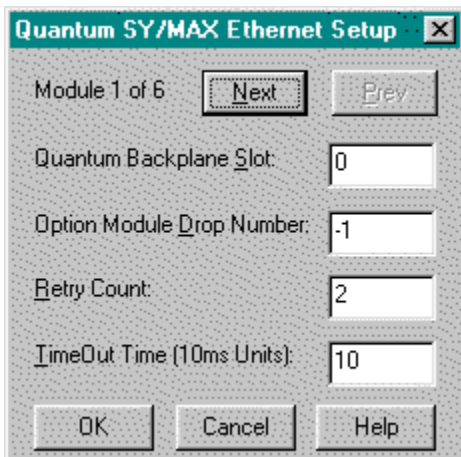

3. Select the particular SY/MAX RIO card you want to configure by selecting the **Next** or **Prev** button, select. The Backplane Slot, Module Drop Number, Retry Count and Timeout change to reflect the current settings of the selected card. The actual value for the Card Number has no effect, as long as you choose a different Card Number for each SY/MAX RIO card you configure.
4. In the **Backplane Slot**, type the slot number that the RIO card inhabits on the local rack. If set to 0, the SY/MAX extension assumes that no card exists.
5. In **Module Drop Number**, type the number of the drop that the selected RIO card controls. Type -1 if the RIO card has no drop to control.
6. In **Retry Count**, type the number of times the controller will try to communicate with the RIO card before it gives up.
7. In **Timeout**, type the number of 10s of milliseconds the controller will wait for communications from the RIO card before it times out.
8. Click **OK**.

MMS ETHERNET

The MMS ETHERNET configuration extension screens provide you with Ethernet connections through quantum MMS Ethernet modules. You are able to configure Option Module Backplane Slot numbers, power ON, reset conditions, NSAP strings, X500 NSAP strings, and local Peer IDs.

NOTE: The Quantum 186 controllers support a maximum of two Option boards and the Quantum 486 controllers support up to 6 option boards (any mix) in the local backplane.

I/O Scanner

The I/O Scanner extension provides data transfer between two or more M1E controllers on a TCP/IP network. The

I/O Scanner allows you to simultaneously configure up to 128 communication transactions. Because the TCP/IP connection is established only once and remains connected during an entire session, it makes this type of I/O Scanner communication very efficient.

The I/O Scanner extension also provides:

Quantum NOE 771 support.

Link Client / Link Server support.

Support for up to 6 NOE 771 modules consisting of 128 transactions each.

To configure the I/O Scanner extension:

1. Click **I/O Scanner Setup** in the **Configuration Extensions** dialog box. The **I/O Scanner** button becomes selectable.
2. Select the **I/O Scanner** button. The parameters for the I/O Scanner appear in the **I/O Scanner Setup** dialog box.

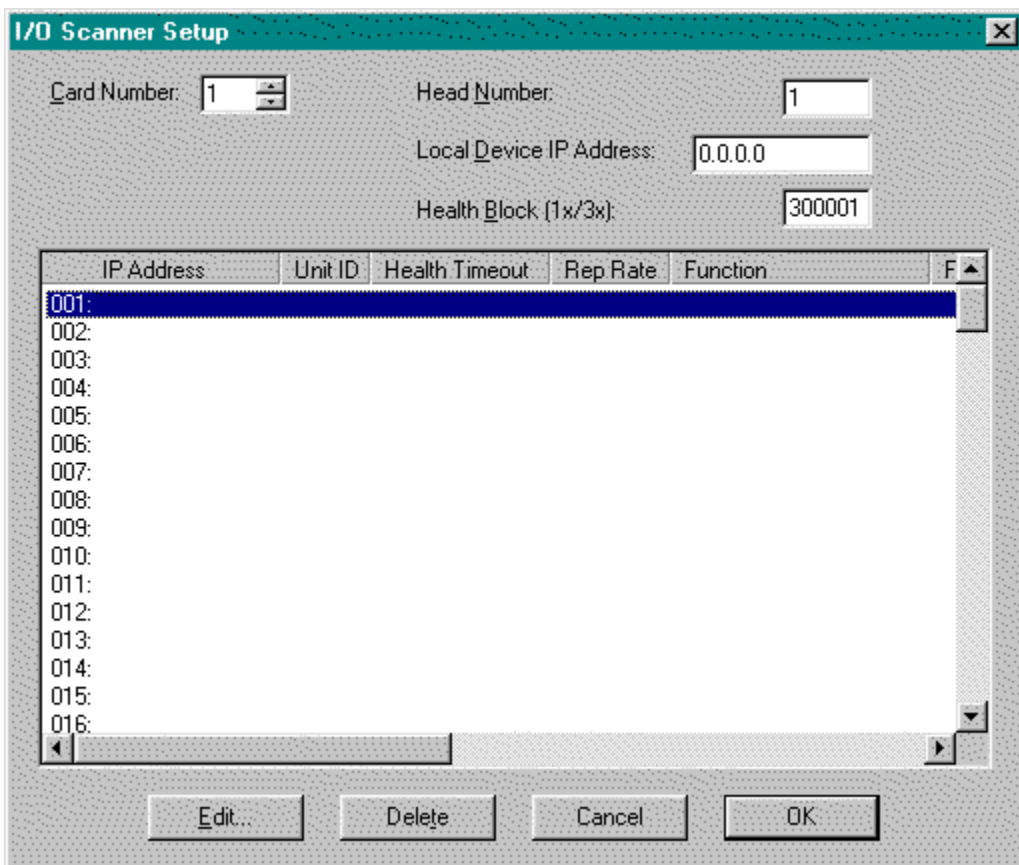

3. Enter the Local Device IP Address.
4. In the Health Block field, type a 1xxxxx or 3xxxxx address.

NOTE: All 1xxxxx addresses are based on a 16-bit boundary. For example, 100001, 100017, 100033, etc.

- Double-click on any transaction or select the **Edit** button to add a new transaction or double-click on an existing transaction select the **Edit** button to edit it. The **Edit I/O Scanner Transaction** dialog box appears.

Below are the added features to the Configuration Extensions dialog box if you are using a Quantum NOE 771 module:

If you are connected to an M1E controller the Card Number spin button is not accessible because only one module is allowed for the M1E controllers.

If you are connected to a Quantum PLC with the NOE 771 module, the Card Number spin button allows a valid range of 1 to 6 (inclusive). Each card number has an associated 128 I/O Scanner transactions.

The Head Number text box replaces the former Master IP Address (Slot) text box. This is the value of the slot in the local rack where the NOE card is located. For M1E controllers, this will always be set to 1.

If you are connected to a Quantum PLC with the NOE 771 module, the Master IP Address text box displays the IP Address of the Quantum controller. This text box only accepts the standard X.X.X.X IP Address format. This feature is not accessible if you are connected to an M1E controller.

Transaction Properties:

Server IP Address

Displays the address of the remote device that you are communicating with.

Unit ID

Contains the value of the destination Unit ID. This is an identifier for a pair of transactions (specifically Link Client/Server transactions). The transaction pair must have matching Unit ID's.

An example situation would include a single Server Write sends data to 3 matching Client Reads in a remote device. All 3 Client Read transactions will accept the data sent from the single Server Write transaction as long as the Unit ID's match.

Health Timeout

Displays a value in milliseconds that represents the length of time to wait for a reply for each transaction.

Repetition Rate

Displays a value in milliseconds that represents the length of time to wait before repeating the transaction. A value of 0 indicates the shortest length of waiting time.

Function

Supports the following function types:

Read: A unilateral read in which a local device reads data from a remote device.

Write: A unilateral write in which a local device writes data to a remote device.

Read/Write: A unilateral read/write in which a local device reads data from and writes data to a remote device.

NOTE: With respect to the unilateral function types, there is no intervention required for the remote devices. They will respond to any Read or Write without the need to setup an I/O Scanner transaction in them.

Link Client Read: A bilateral function type in which a local device responds to a write transaction from a remote device that must have a matching server write.

Link Client Write: A bilateral function type in which a local device writes to a remote device that must have matching server read and write.

Link Client Read/Write: A bilateral function type in which a local device reads and writes data to and from a remote device that must have a matching server read.

Link Server Read: A bilateral function type in which a local device initiates a read from a remote device. The remote device must have a matching client write.

Link Server Write: A bilateral function type in which a local device writes to a remote device. The remote device must have a matching client read.

Link Server Read/Write: A bilateral function type in which a local device reads and writes data to and from a remote device that must have a matching client read/write.

Fallback Value

Zero: Select to reset the data values for the selected transaction (upon a power loss) to zero.

Hold Last: Select to retain and make the last data values for the selected transaction (upon a power loss) available at restart.

Read Ref Local

Represents the local data address that receives data from the remote controller.

Read Ref Remote

Represents the remote address where the read data is coming from.

Read Count

Represents the number of sequential registers to read. There are up to 125 registers allowed.

Write Ref Local

Represents the local data address that sends data to the remote controller.

Write Ref Remote

Represents the remote address where the write data is going.

Write Count

Represents the number of sequential addresses to write. There are up to 100 addresses allowed.

The Compact Phase II dialog is accessed through the Configuration Extension dialog. The Compact Phase II is available for 984-E258/E275, E265, E285 processors.

Compact Phase II Configuration

The Compact Phase II dialog allows the SDA Size, RTS and CTS Delays to be modified both online and offline.

The valid SDA Size range is 0 to 128.

The valid RTS Delay and CTS Delay ranges are 0 to 50.

The **Clear Password** push button is enabled only when online with a PLC in which the Compact Phase II is defined and contains a password.

NOTE: A password can ONLY be removed. It cannot be reentered or replaced.

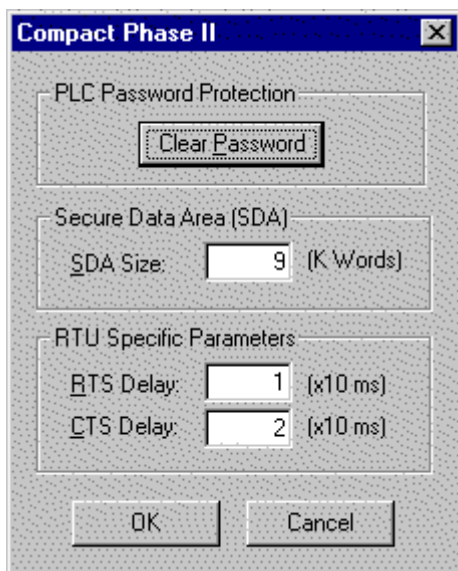
**Attaching to Processors which contain the Compact Phase II Configuration Extension**

Processors containing the Compact Phase II configuration extension *with* a password require the password to be entered before logging in to the PLC. However, users can choose to attach to the PLC without logging in or entering a password through the **PLC Password** dialog below.



To log in to the PLC, select the **Attach with Login** radio button and enter the Compact Phase II password in the edit box.

To attach to the PLC without logging in, select the **Attach without Login** radio button to proceed online with the PLC without logging in.

Special Considerations Regarding the Compact Phase II Configuration Extension and Loading Programs into Processors

Programs with or without the Compact Phase II configuration extension can be loaded into a PLC with or without its own Compact Phase II. The following rules determine how the Compact Phase II is loaded from a file into the PLC.

1. If a program file contains the Compact Phase II configuration extension and the PLC does not, all the Compact Phase II settings from the file are loaded into the PLC *except* for the password. The Compact Phase II in the PLC will not include the password from the file.
2. If a program contains the Compact Phase II configuration extension and the PLC already contains its own Compact Phase II configuration extension, all the Compact Phase II settings from the file will be loaded into the PLC *except* for the password. The PLC will retain its original password (or no password if none was originally present in the PLC).
3. If a program does not contain the Compact Phase II configuration extension and the PLC does contain its own Compact Phase II, the warning below appears.

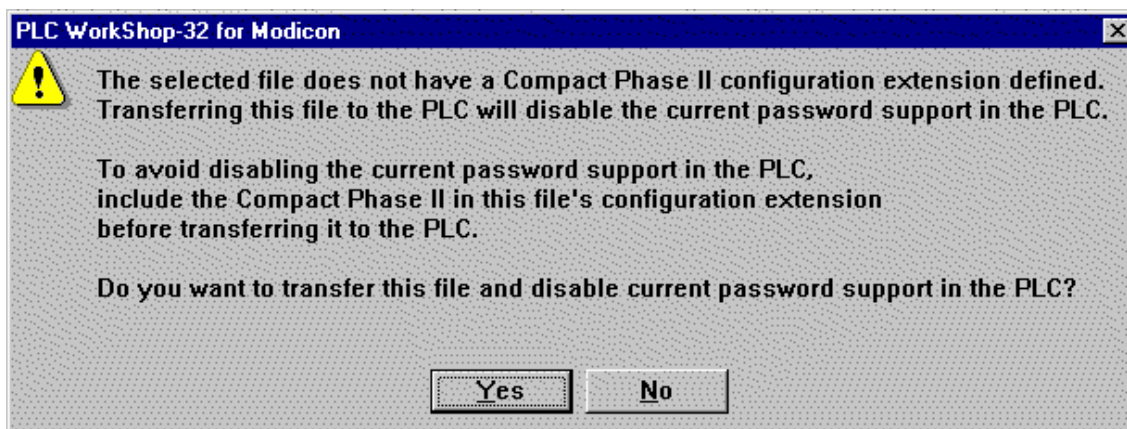

Click the **Yes** button to transfer the program in the file to the PLC and *eliminate* the Compact Phase II from the PLC.

Click the **No** button to terminate the transfer of the program from the file to the PLC. The original program and Compact Phase II configuration extension in the PLC remain unchanged.

Profibus

This extension allows Quantum Revision 2.xx controllers to connect to a Profibus network. To accomplish this, first verify that you have the following software (included with the Profibus module as *Profibus DP Configuration Pack for CRP 811, Modicon Part # 332SPU83301*) installed:

- The **Profibus DP Configurator** from Softing GmbH
- The **SPU931 I/O Mapping Utility** from Modicon

NOTE: The above utilities are not FasTrak SoftWorks, Inc. products. You are advised to use the Profibus DP Configurator and the SPU931 I/O Mapping Utility at your own risk. Consult each product's respective documentation for more information and support.

Next, verify that the relevant I/O modules are loaded into the **Traffic Cop**.

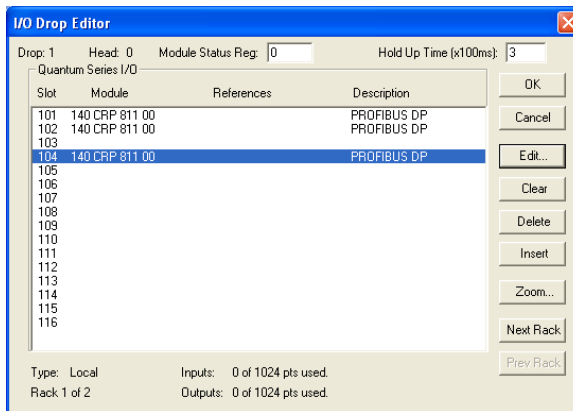

The Profibus DP module number (required to continue) is **140 CRP 811 00**.

To add the Profibus extension:

1. Select the **Profibus** checkbox in the **Configuration Extensions** dialog. The **Profibus Extension** setup dialog appears.

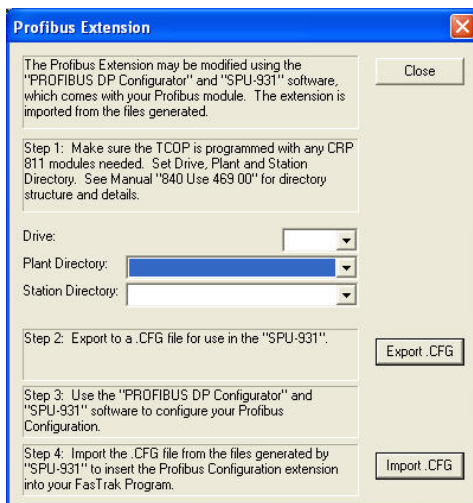

2. Set the Drive, Plant Directory, and Station Directory for use with the configuration utilities. See Modicon's *Profibus DP Configurator for CRP 811 Typ: 332 SPU 931 01* manual for more information on directory settings.
3. Click the **Export .CFG** button to export a configuration file to the Station Directory.

4. Configure the Profibus modules with the **Profibus DP Configurator** and **SPU931** utilities using the exported *.CFG file. Consult each product's respective documentation for more information on configuration options.
5. After completing configuration, click the **Import .CFG** button to import the extension to WorkShop.
6. Click **OK** to return to the **Configuration Extensions** dialog.

Loadables

Setting up the loadable modules is the next step in configuring the PLC. The loadable modules window displays the total number of logic words free, the number of DX modules for the current PLC type, the currently selected path for loadable files and two list boxes.

The list box on the left displays a list of the loadables stored in the Selected Loadable file. The loadable instruction name, PLC Type (-80, ABX or 584), loadable size and opcode are listed for each loadable stored in the file.

The list box on the right displays a list of the loadables in the current program. The loadable instruction name, PLC type (-80, ABX or 584), loadable size and opcode are listed for each loadable in the current program.

NOTE: B984-100 and the B984-102 processors do not support loadable modules.

To access the loadable modules configuration;

1. From the **Utilities** menu, click **Loadables** in the **PLC Configuration** dialog box. The **Loadables** dialog appears.

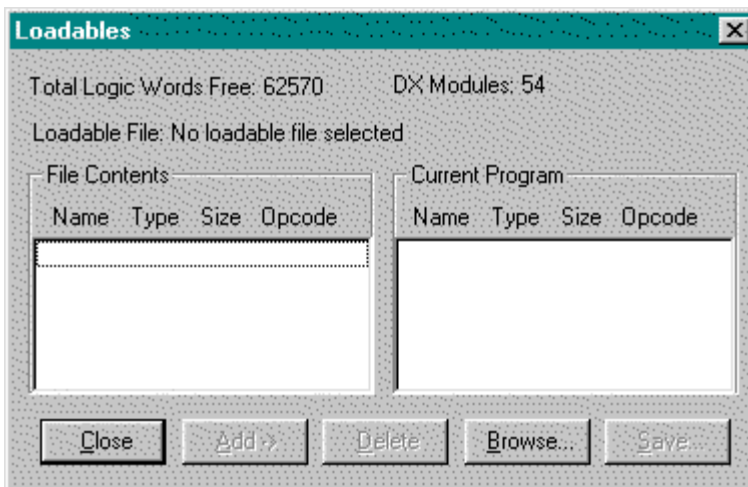

2. Click **Add** to add the selected loadable in the **File Contents** area to the **Current Program** area. Be certain that the loadable is the correct type for the current program.
3. Click **Delete** to remove the selected loadable from the **Current Program** area of the **Loadables** window.

NOTE: A loadable that appears in the program logic must first be removed from the logic, before it can be removed from the configuration.

3. Click **Browse** to search directories and files for new loadable modules with a *.DAT or *.EXE extension.

- The **Save** button is only available offline. The **Save** button is only highlighted when a single loadable in the right list box is selected. Click the **Save** button to open the **Save File** dialog. This allows the user to save the loadable to a *.DAT or *.EXE file so it can be loaded into a new or reconfigured PLC program.
- Click **OK** to enter your changes. Click **Cancel** to disregard changes to the **Loadables** box and return to the **PLC Configuration** box.

Set Clock

The final step in configuring your PLC is to set the PLC's clock.

NOTE: The **Set Clock** configuration is not support by all processors.

To access the clock setup:

- Click **Set Clock** in the **PLC Configuration** box and the **Set** dialog appears.

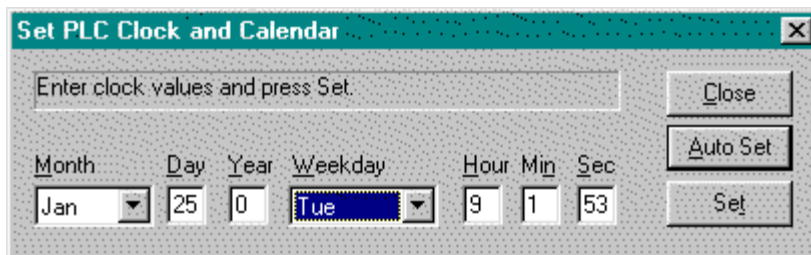

- Enter the current Month, Day, Year, Weekday, Hour, Minute and Second in military time. Clicking on the **Auto Set** button sets the clock to the current computer's time and date.
- Click **Set** to enter your changes. Click **Cancel** to disregard your changes and return to the PLC Configuration box.

PLC Status

Use the PLC Status dialog to obtain information about operational status, configuration, error conditions, etc. of an online PLC.

To access the PLC Status dialog, select the **PLC Utilities / PLC Status** menu item. A **PLC Status** dialog similar to the following appears.

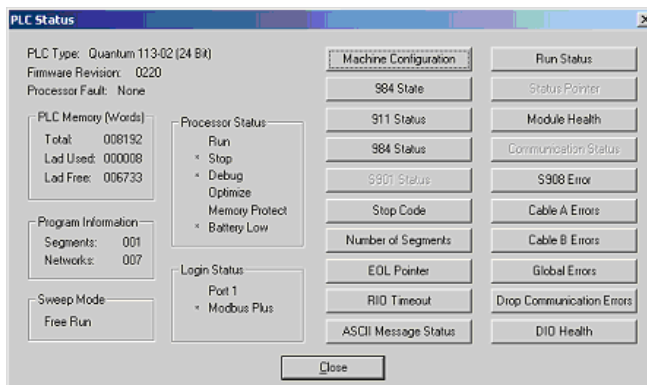

There are 20 specific PLC Status dialogs. Because no single PLC type uses them all, the ones that do not apply to the PLC being used are disabled. In the example above of a PLC Status dialog for a Quantum PLC, three dialogs are disabled.

To access one of the dialogs, click the applicable button on the right half of the main PLC Status dialog. For example, when the **Machine Configuration** button is clicked, the **Machine Configuration** dialog appears.

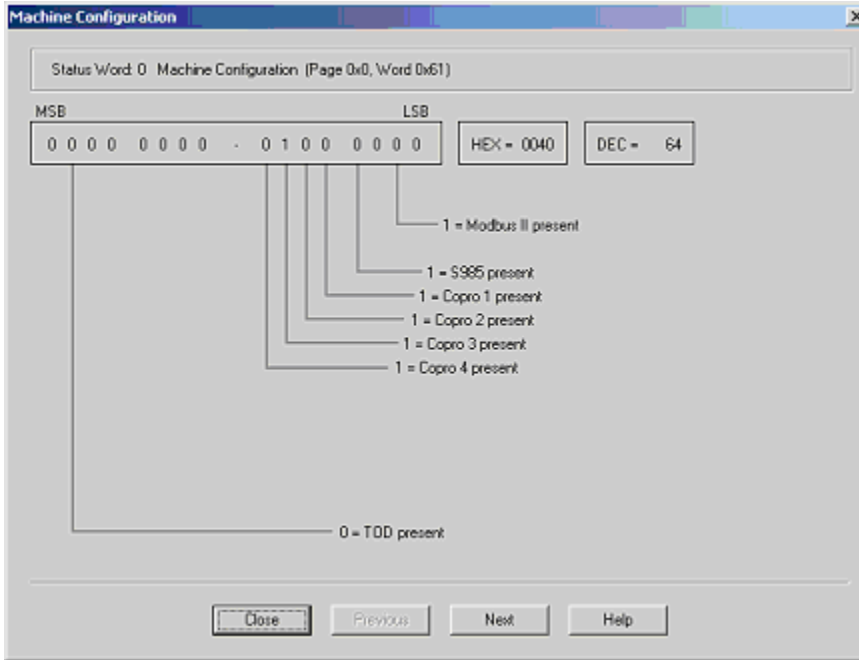

The Machine Configuration dialog illustrates the basic format of each PLC Status dialog.

A data WORD is read from the PLC. This WORD is displayed in binary, hexadecimal, and decimal formats. The purpose of each bit (or group of bits) is broken out and displayed below the binary representation. When any status dialog is displayed, the data WORD used in the dialog is read from the PLC every half second, virtually updating the displayed information continuously.

NOTE: All of the PLC Status dialogs read data from the PLC, but no data is written to the PLC by the dialogs.

Click the **Next** button to access the next status dialog offered in the main PLC Status dialog. In the example listed above, clicking the **Next** button displays the **984 State** dialog.

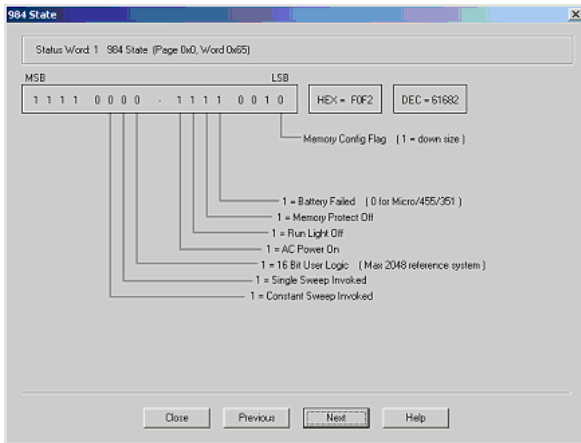

Click the **Previous** and **Next** buttons to display the adjacent status dialogs for the current PLC.

Information about the following PLC Status dialogs follows:

- 911 Status
- 984 State
- 984 Status
- ASCII Message Status
- Cable A Errors
- Cable B Errors
- Communication Status
- Controller State
- Controller Status
- DIO Health
- Drop Communication Errors
- End of Logic Pointer
- Global Errors
- Machine Configuration
- Module Health
- Number of Segments
- Remote I/O Timeout
- Run Status
- S901 Status
- S908 Error
- Status Pointer
- Stop Code

Machine Configuration

To access the Machine Configuration dialog:

1. Access the **PLC Status** dialog by selecting the **PLC Utilities / PLC Status** menu item.
2. Click the **Machine Configuration** button. The **Machine Configuration** dialog, which varies based on PLC type, appears.

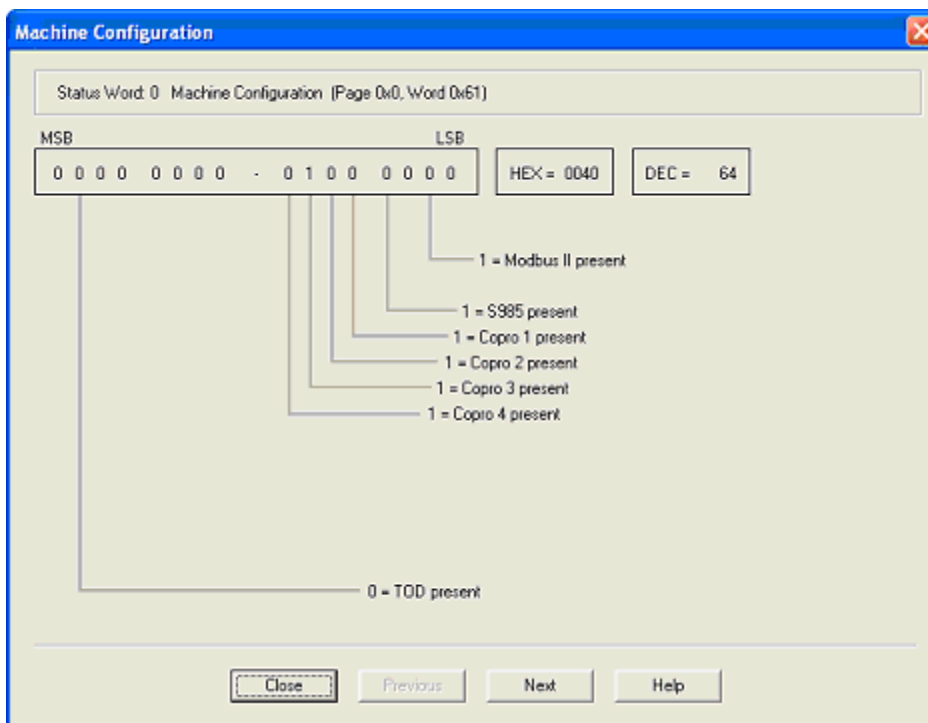

Word 61 Hex (97 Decimal)

Machine Configuration indicates the options present in the controller including:

Remote I/O (S908 processor)

Modbus II

Hot Standby

Distributed Control Processor (D908)

Coprocessors

Machine Configuration also indicates the presence of the Time of Day option and the remote I/O adapter size.

NOTE: Some S908 remote I/O processor versions support 6 remote drops only. A '1' indicates the option is present.

Controller State

To access the Controller State dialog:

1. Access the **PLC Status** dialog by selecting the **PLC Utilities / PLC Status** menu item.
2. Click the **Controller State** button. The **Controller State** dialog appears.

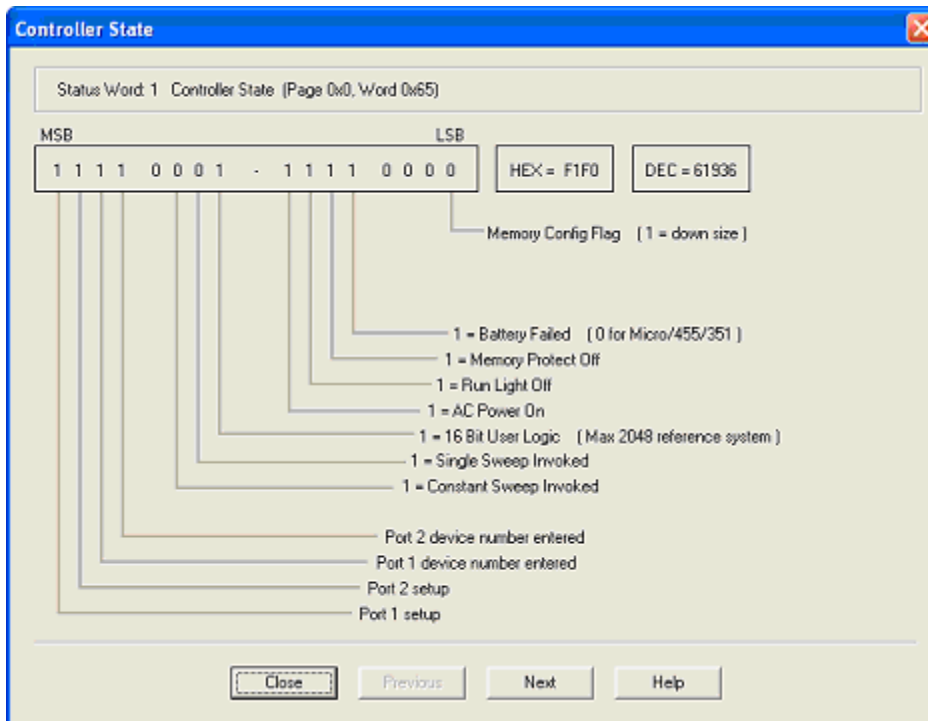

S908 or S901 Controller

Word 65 Hex (101 Decimal)

The State word contains size and state information of the controller. A state is any condition that is set for the life of the controller (16-bit vs. 24-bit) or set by external events (memory protect).

The down size flag indicates controllers with less than 4K of logic memory.

The 16-bit user logic bit indicates controllers that support 2048 references.

S908 Controller Only

The upper bits are unused for 984/S908 or -80 -85 controllers.

Some Micro 984 controllers indicate 0 for battery failed.

NOTE: The 984B and the 780/785 are 24-bit controllers.

984 State

To access the 984 State dialog:

1. Access the **PLC Status** dialog by selecting the **PLC Utilities / PLC Status** menu item.
2. Click the **984 State** button. The **984 State** dialog appears.

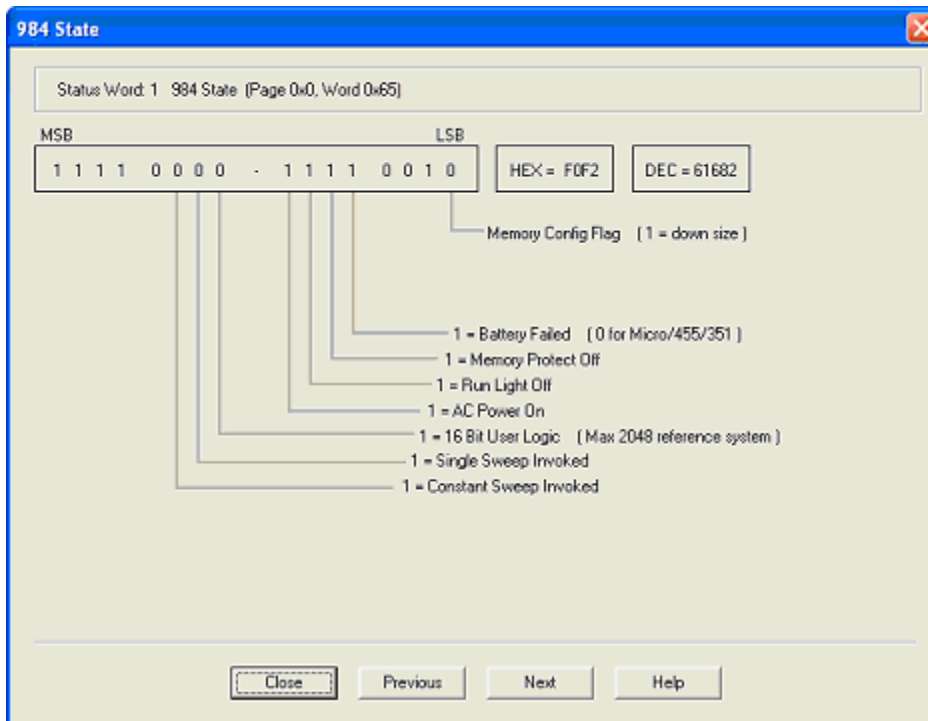

S908 or S901 Controller

Word 65 Hex (101 Decimal)

The State word contains size and state information of the controller. A state is any condition that is set for the life of the controller (16-bit vs. 24-bit) or set by external events (memory protect).

The down size flag indicates controllers with less than 4K of logic memory.

The 16-bit user logic bit indicates controllers that support 2048 references.

S908 Controller Only

The upper bits are unused for 984/S908 or -80 -85 controllers.

Some Micro 984 controllers indicate 0 for battery failed.

NOTE: The 984B and the 780/785 are 24-bit controllers.

911 Status

To access the 911 Status dialog:

1. Access the **PLC Status** dialog by selecting the **PLC Utilities / PLC Status** menu item.
2. Click the **911 Status** button. The **911 Status** dialog appears.

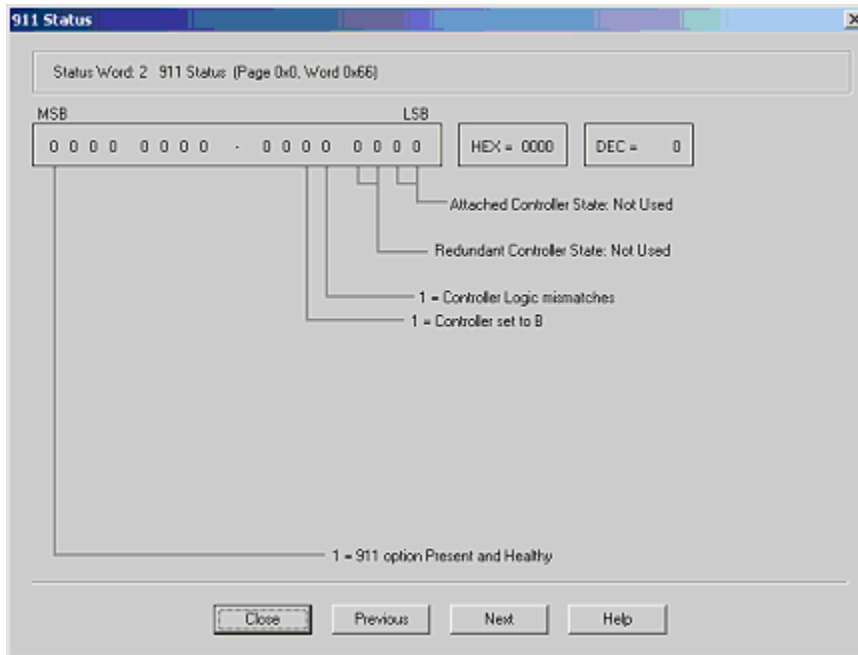

911 Hot Standby Status (S908)

Word 66 Hex (102 Decimal)

The Hot Standby Status is valid when a redundancy system is present.

This status reports the system presence and health. It also indicates if the unit is the primary or secondary controller.

Controller Status

To access the Controller Status dialog:

1. Access the **PLC Status** dialog by selecting the **PLC Utilities / PLC Status** menu item.
2. Click the **Controller Status** button. The **Controller Status** dialog appears.

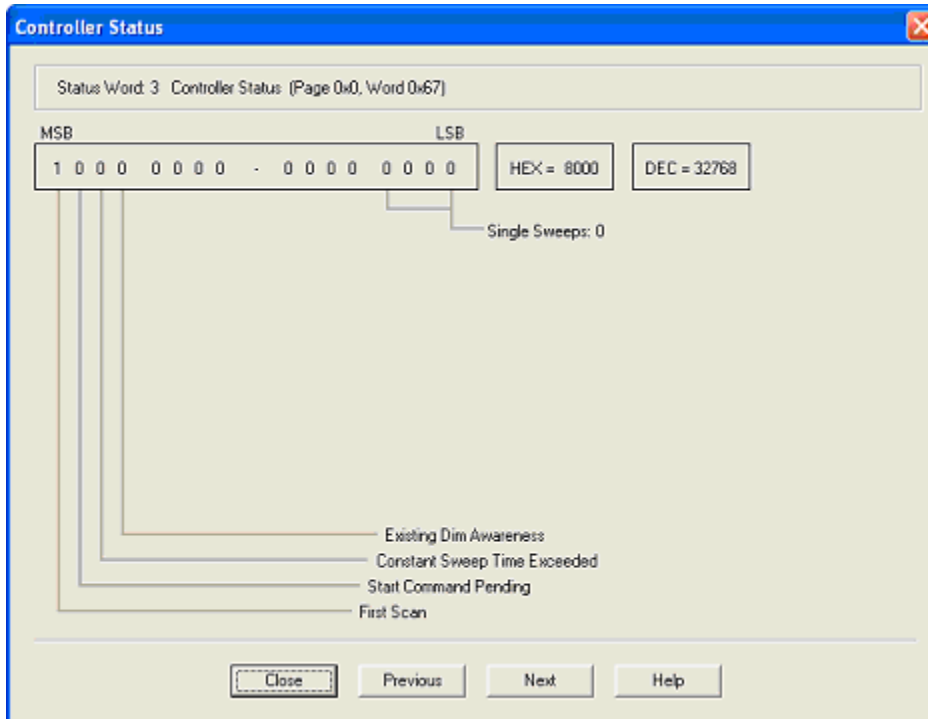

S908 or S901 Controller

Word 67 Hex (103 Decimal)

This Status word indicates specific statuses of the controller. Statuses are any conditions that change while the controller is running, usually from an internal event.

984 Status

To access the 984 Status dialog:

1. Access the **PLC Status** dialog by selecting the **PLC Utilities / PLC Status** menu item.
2. Click the **984 Status** button. The **984 Status** dialog appears.

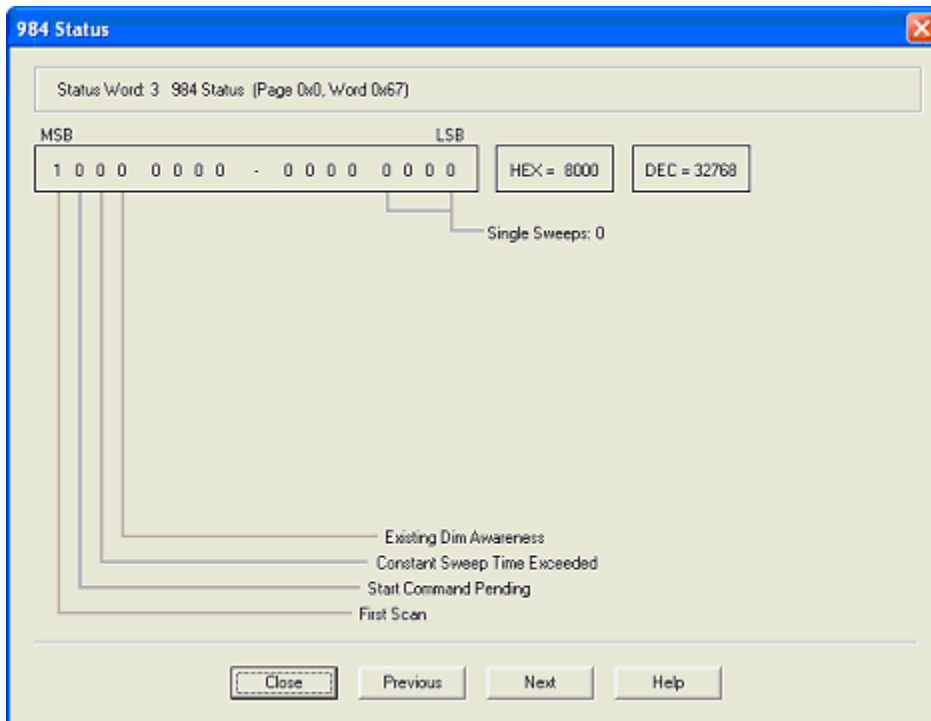

S908 or S901 Controller

Word 67 Hex (103 Decimal)

This Status word indicates specific statuses of the controller. Statuses are any conditions that change while the controller is running, usually from an internal event.

S901 Status

To access the S901 Status dialog:

1. Access the **PLC Status** dialog by selecting the **PLC Utilities / PLC Status** menu item.
2. Click the **S901 Status** button. The **S901 Status** dialog appears.

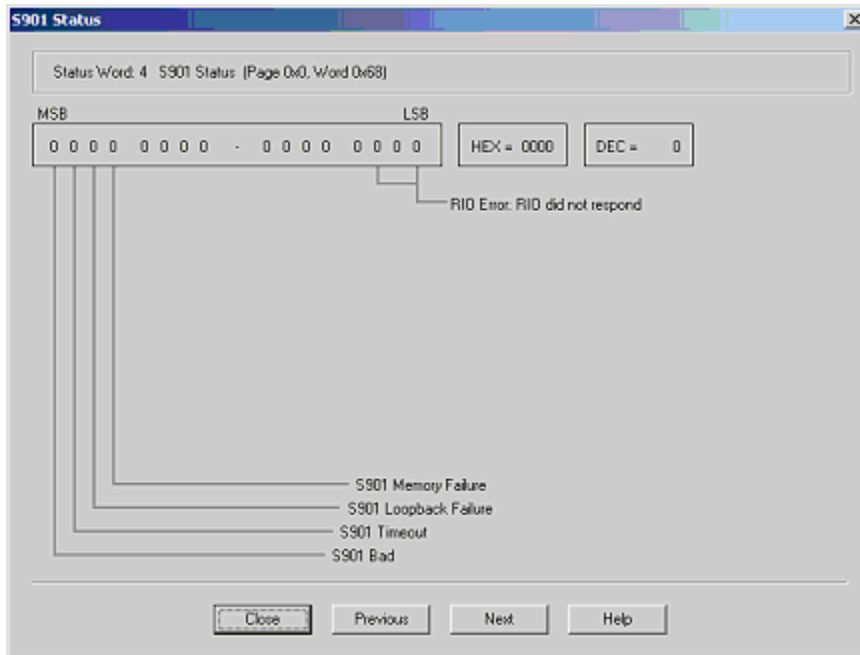

Word 68 Hex (104 Decimal)

This Status word indicates the remote I/O processor status.

The upper 4 bits should be zero under normal operating conditions. An error indicates a failure in the remote I/O processor.

Number of Segments

To access the Number of Segments dialog:

1. Access the **PLC Status** dialog by selecting the **PLC Utilities / PLC Status** menu item.
2. Click the **Number of Segments** button. The **Number of Segments** dialog appears.

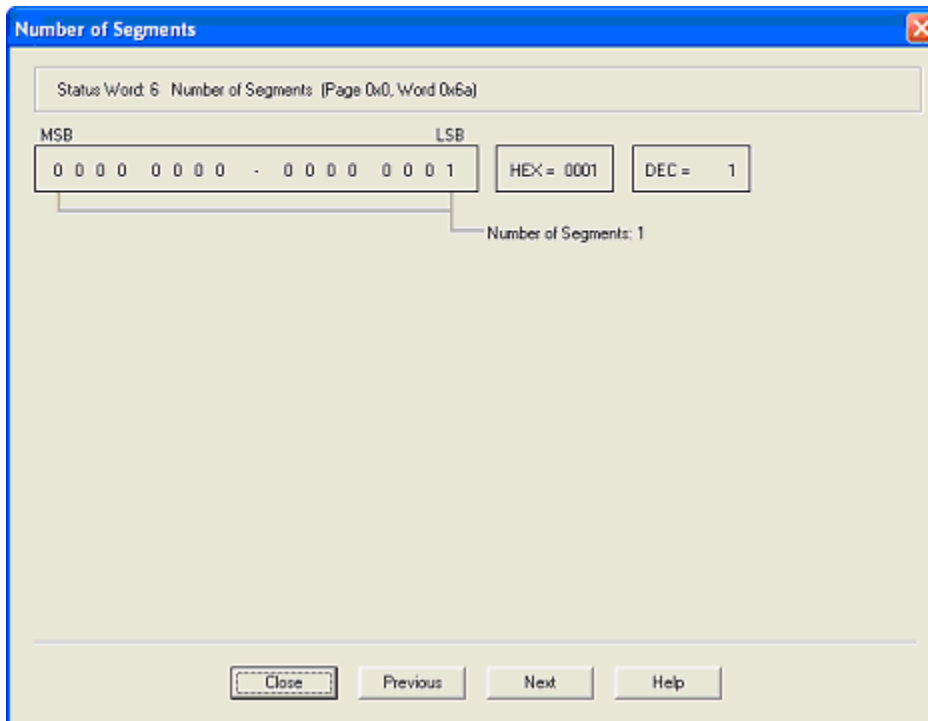

Word 6A Hex (106 Decimal)

The Number of Segments is verified when the controller is powered. This is the number of I/O exchange nodes plus 1 (for end of logic). If this number is not verified, a stop code of 0100 would result.

Remote I/O Timeout

To access the Remote I/O Timeout dialog:

1. Access the **PLC Status** dialog by selecting the **PLC Utilities / PLC Status** menu item.
2. Click the **Remote I/O Timeout** button. The **Remote I/O Timeout** dialog appears.

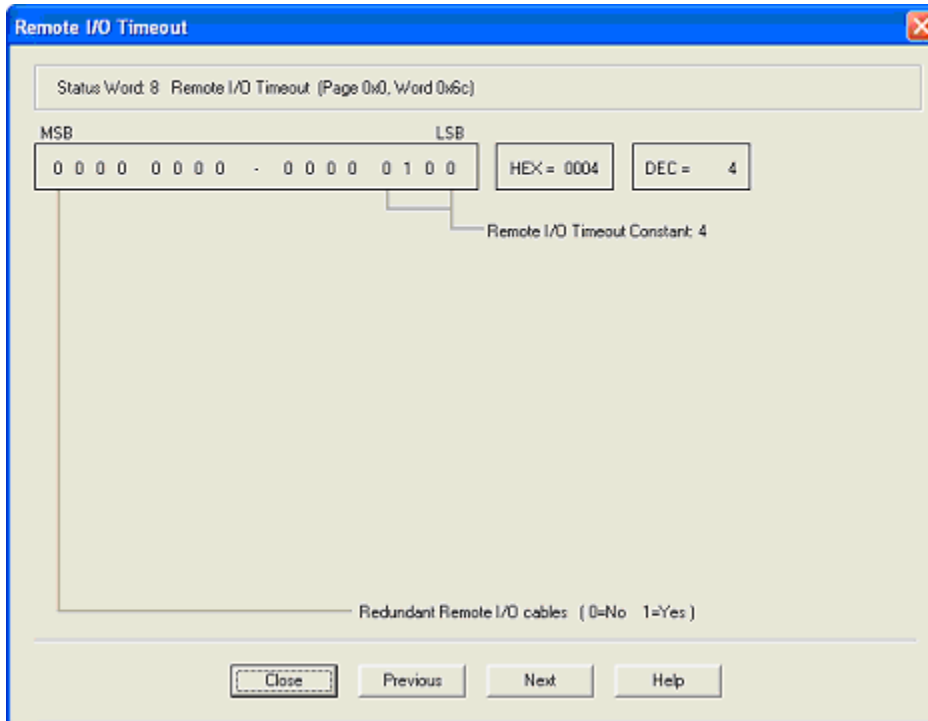

Word 6C Hex (108 Decimal)

The RIO Timeout word contains the Remote I/O time-out constant. The highest bit of this word indicates if redundant cables are present.

NOTE: Cable A and Cable B are used for remote I/O communications.

ASCII Message Status

To access the ASCII Message Status dialog:

1. Access the **PLC Status** dialog by selecting the **PLC Utilities / PLC Status** menu item.
2. Click the **ASCII Message Status** button. The **ASCII Message Status** dialog appears.

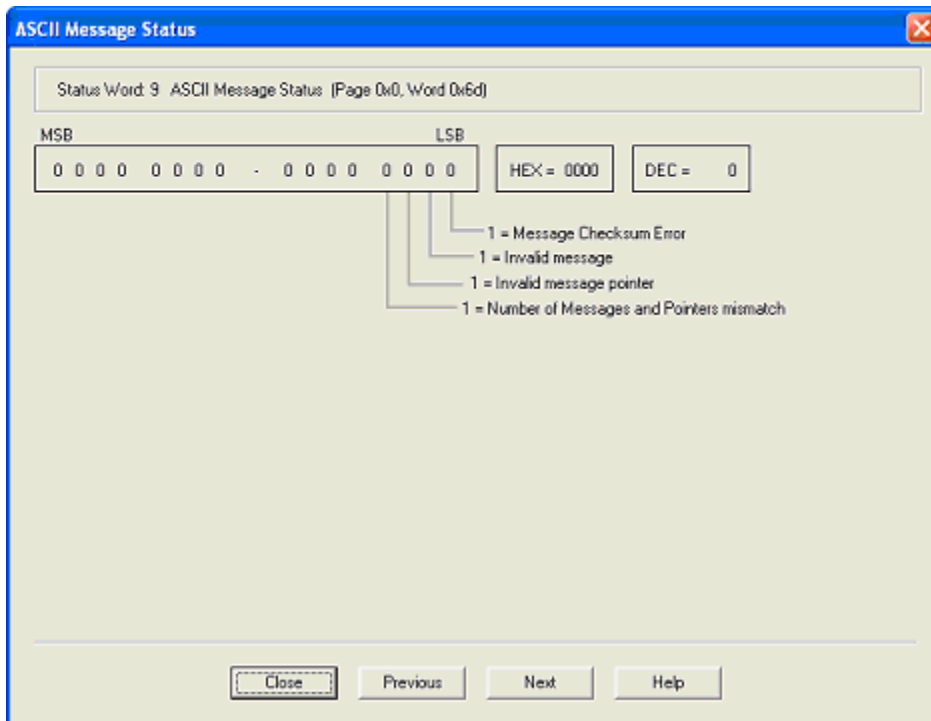

Word 6D Hex (109 Decimal)

This word indicates the status of the ASCII Message database. Bits in this word indicate errors occurred while creating or editing ASCII messages.

Status Pointer

To access the Status Pointer dialog:

1. Access the **PLC Status** dialog by selecting the **PLC Utilities / PLC Status** menu item.
2. Click the **Status Pointer** button. The **Status Pointer** dialog appears.

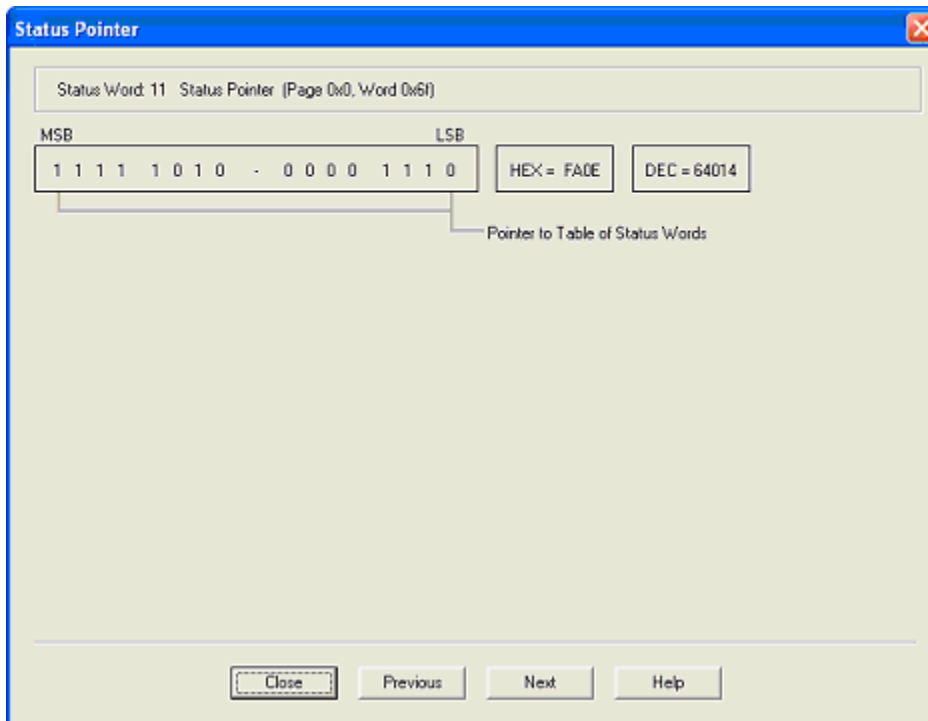

The address in Word 6F Hex points to a table of pointers that is 76 words long.

NOTE: This 76-word long table is a table of address pointers for the 75-word long system status area.

Module Health

To access the Module Health dialog:

1. Access the **PLC Status** dialog by selecting the **PLC Utilities / PLC Status** menu item.
2. Click the **Module Health** button. The **Module Health** dialog appears.

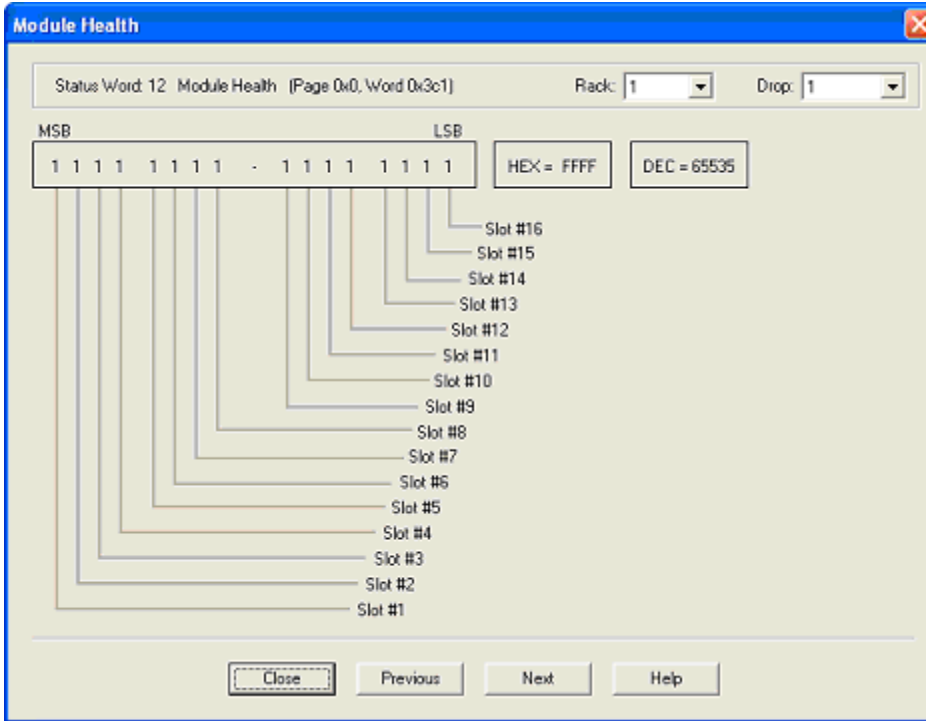

S908 Controller

Module Health Status information consists of up to 160 words. A single bit is used to represent the Health Status of a single module. A binary '1' means that the module is healthy. Each drop in the I/O sub system has five words allocated to contain I/O module status. Each of these five words contains the I/O module status of a single rack within the drop. The most significant bit (MSB) represents the status of the module in slot 1. Slot 2 module status is represented by the bit to the immediate right of the MSB.

A healthy I/O module must meet the following conditions:

The specified slot must be configured in the Traffic Cop.

The slot must contain the module specified in the Traffic Cop.

Valid communication must exist between the module and the interface.

Valid communication must exist between the interface module and the controller.

 Warning	<p>On systems using J890/J892s with PROM rev 1000, slot 1 will be the LSB. J890/J892s with PROM revs greater than 1000 will appear as previously described. The earlier J890/J892s should be upgraded, as they will be incompatible with any user programming that assumes slot 1 status to be the MSB.</p>
--	---

NOTE: The bit will be 1 if a module is configured in the Traffic Cop and active.

S901 Controller

The I/O Module Health Status information consists of words that represent the module health for channel pairs.

Each word represents 2 channels. The words are also divided into input modules and output modules. A single bit is used to represent the Health Status of a single module.

If the slot is inhibited in the Traffic Cop then the bit will be a '0'. If the slot contains an input module then the bit will be a '1'. This will not be the case if the "Communication Status Word 2/2 (183)" indicates an error.

If the slot contains an output module and if the active light is on then this bit will be a '1'. If the active light is off then this bit will be a '0'. It is common to set the status indicator for an output slot to toggle between '0' and '1' when active and healthy.

The Upper byte contains the status of the lower channel number of the channel pair (for example, channel 1 for channel pair 1/2). The lower byte contains the status of the higher channel number of the channel pair. Each byte represents the status of slots 1 to 8 of the channel. The Most Significant Bit of the channel represents slot 1 and the Least Significant Bit shows the status of slot 8.

Communication Status

To access the Communication Status dialog:

1. Access the **PLC Status** dialog by selecting the **PLC Utilities / PLC Status** menu item.
2. Click the **Communication Status** button. Screen 1 of 2 of the **Communication Status** dialog appears.

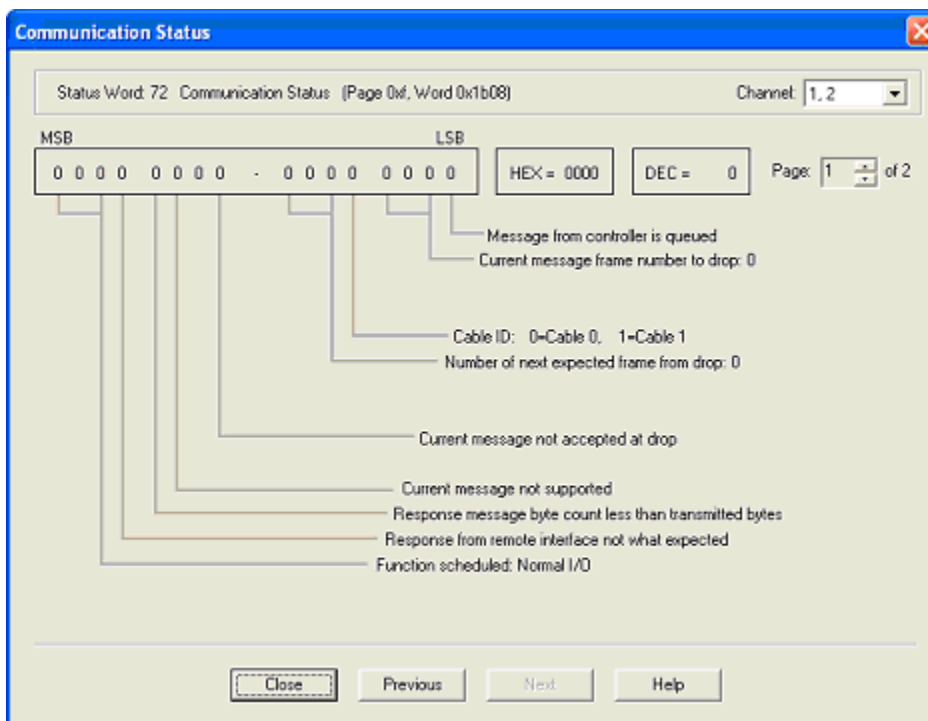

Communication Status (S901)

The Remote I/O communication Status Word 1 shows errors and the normal operating indication of the indicated channel pair.

Under normal operating conditions, the lower byte should count. The upper portion of the byte should match the lower portion of the byte.

Any bits set in the upper byte indicate an error condition for the indicated channel pair.

NOTE: A disconnected channel pair or a channel pair that does not exist will set the function scheduled to 001 (Restart - communication reset).

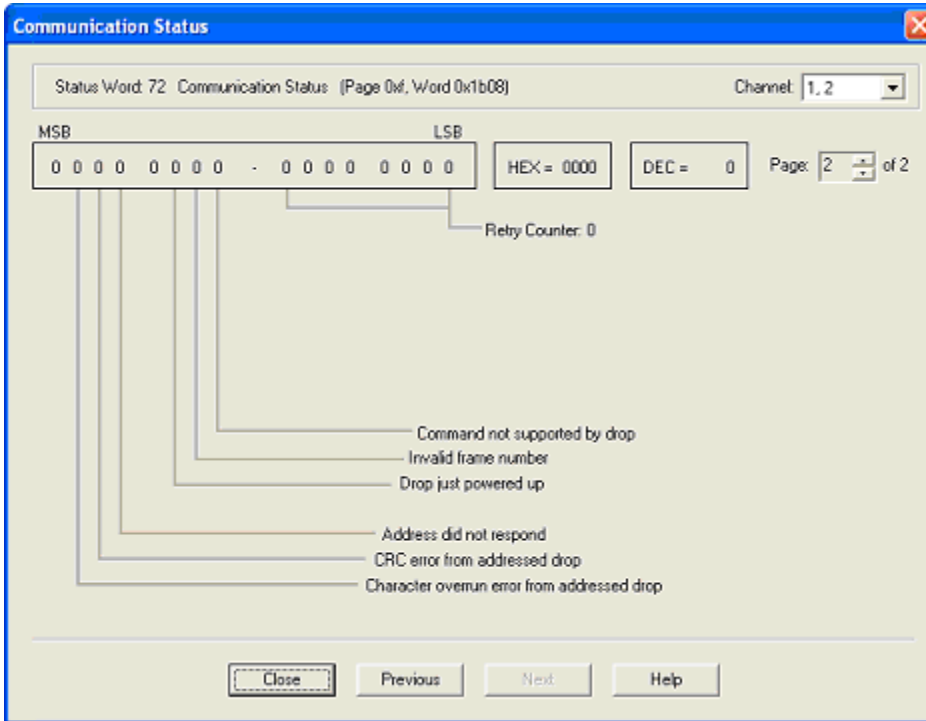

The Remote I/O communication Status Word 2 shows errors and the retry count on lost communications. If communication is lost with the indicated channel pair, the corresponding error bit is set and the retry counter increments. If the retry counter counts to its maximum, other indicators are affected. Module health is shown as '0'.

If communication is re-established, the error count and error word are not cleared.

The only way to clear this word is to cycle power on the controller or issue a start and stop command.

S908 Error

To access the S908 Error dialog:

1. Access the **PLC Status** dialog by selecting the **PLC Utilities / PLC Status** menu item.
2. Click the **S908 Error** button. The **S908 Error** dialog appears.

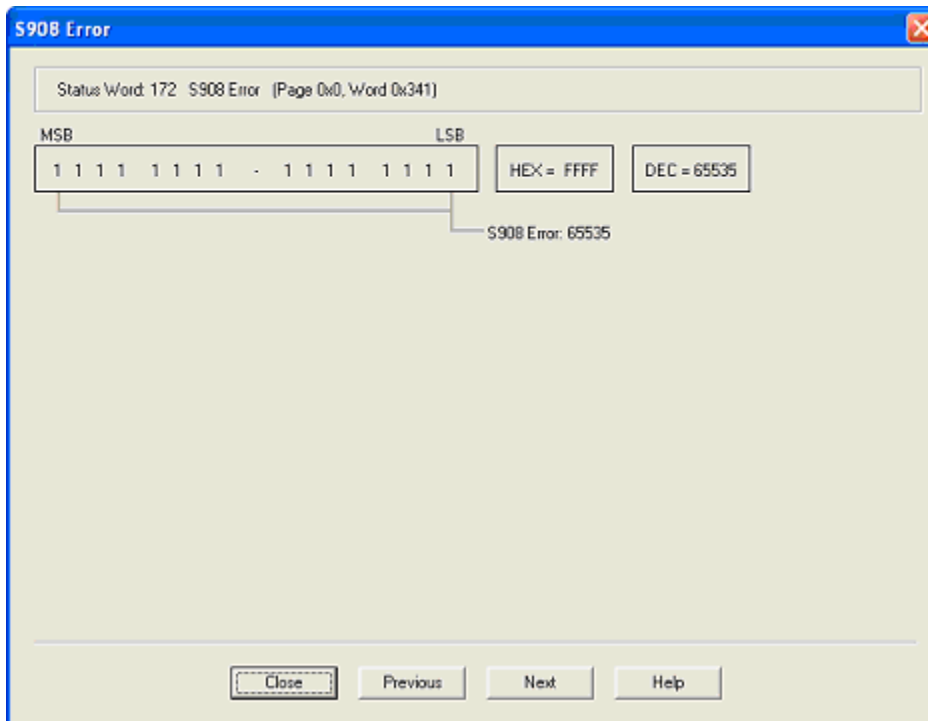

The S908 Error word contains the S908 start error code. This word is always 0000 in a running system.

If an error occurs, the controller will not start and generates a stop code system error of 4000.

1 Bad Traffic Cop Length	23 Bad Number of Input Bytes
2 Bad Remote I/O Link Number	25 Bad First Reference Number
3 Bad Number of Drops	26 Bad Second Reference Number
4 Bad Traffic Cop Checksum	27 No Input or Output Bytes
10 Bad Drop Descriptor Length	28 Discrete Not on 16 Bit Boundary
11 Bad I/O Drop Number	30 Unpaired Odd Output Module
12 Bad Drop Holdup Time	31 Unpaired Odd Input Module
13 Bad ASCII Port Number	32 Unmatched Odd Module Reference
14 Bad Number of Modules in Drop	33 1xxxx Reference After 3xxxx Register
15 Drop Already Configured	34 Dummy Module Reference Already Used

16 Port Already Configured	35 3xxxx Module Not a Dummy
17 More than 1024 Outputs	36 4xxxx Module Not a Dummy
18 More than 1024 Inputs	40 Dummy Then Real 1xxxx Module
20 Bad Module Slot Address	41 Real Then Dummy 1xxxx Module
21 Bad Module Rack Address	42 Dummy Then Real 3xxxx Module
22 Bad Number of Output Bytes	43 Real Then Dummy 3xxxx Module

Cable A Errors

Cable A is the main cable connecting the remote I/O Processor to the Remote I/O Interface.

To access the Cable A Errors dialog:

1. Access the **PLC Status** dialog by selecting the **PLC Utilities / PLC Status** menu item.
2. Click the **Cable A Errors** button. Screen 1 of 3 of the **Cable A Errors** dialog appears.

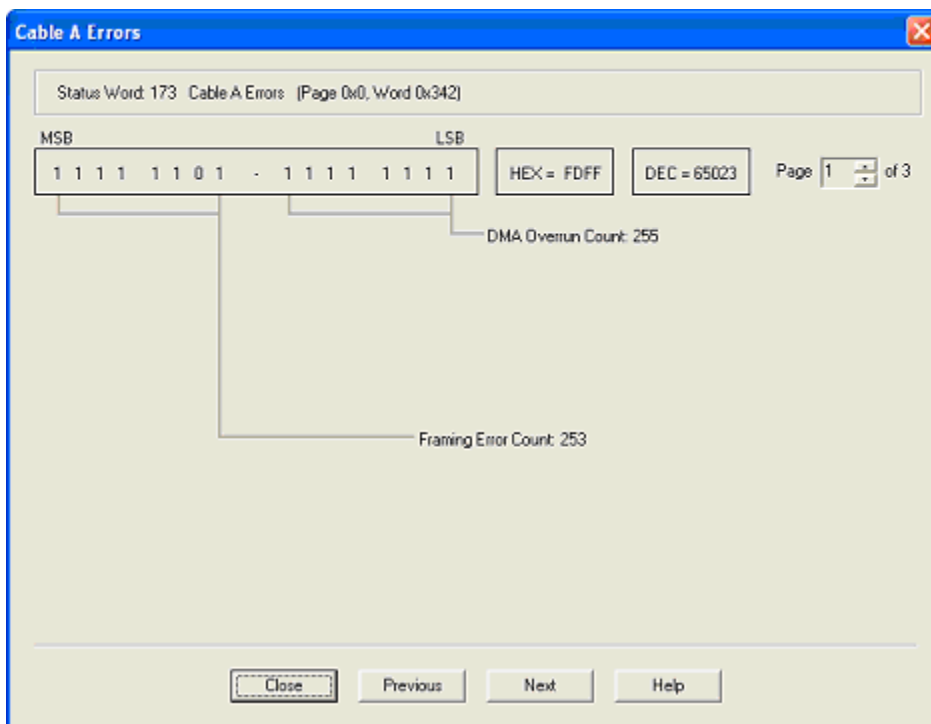

Status Word 173 is the count of frame size errors and DMA overrun errors. The high order byte represents a count of Cable A frame size errors. This indicates that the length of the data message was incorrect. The low order byte represents a count of DMA receiver overrun counts. This indicates that the hardware had more data to send than was required.

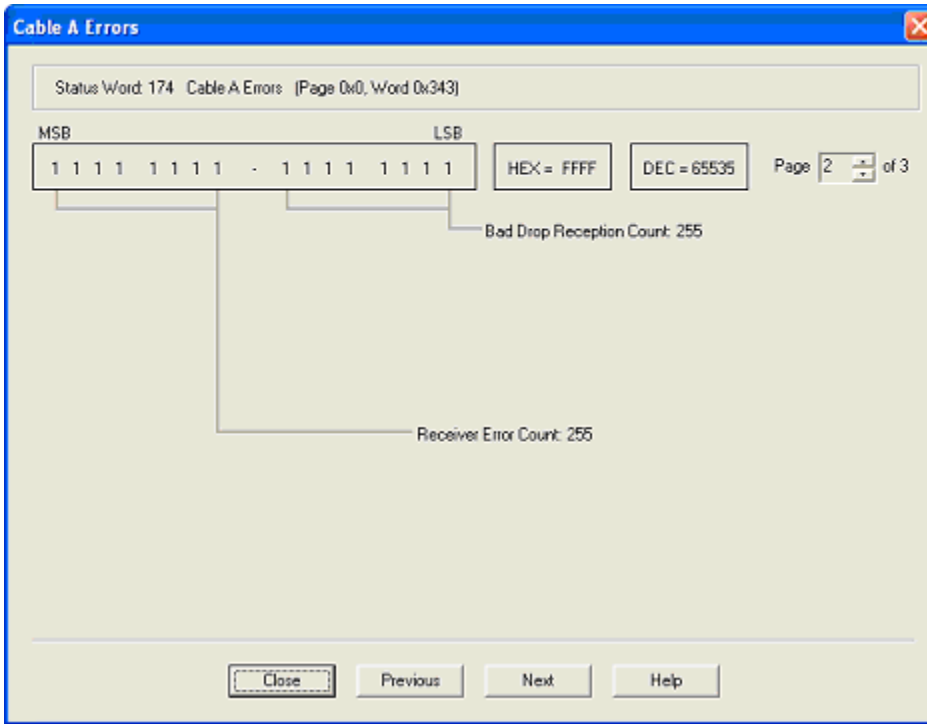

Status Word 174 is the Cable A LAN receiver error counter and the Bad Drop reception on cable A counter. This indicates a cable or noise problem to a drop. The “Drop Communication Errors (173)” should be examined to determine which drop is having problems.

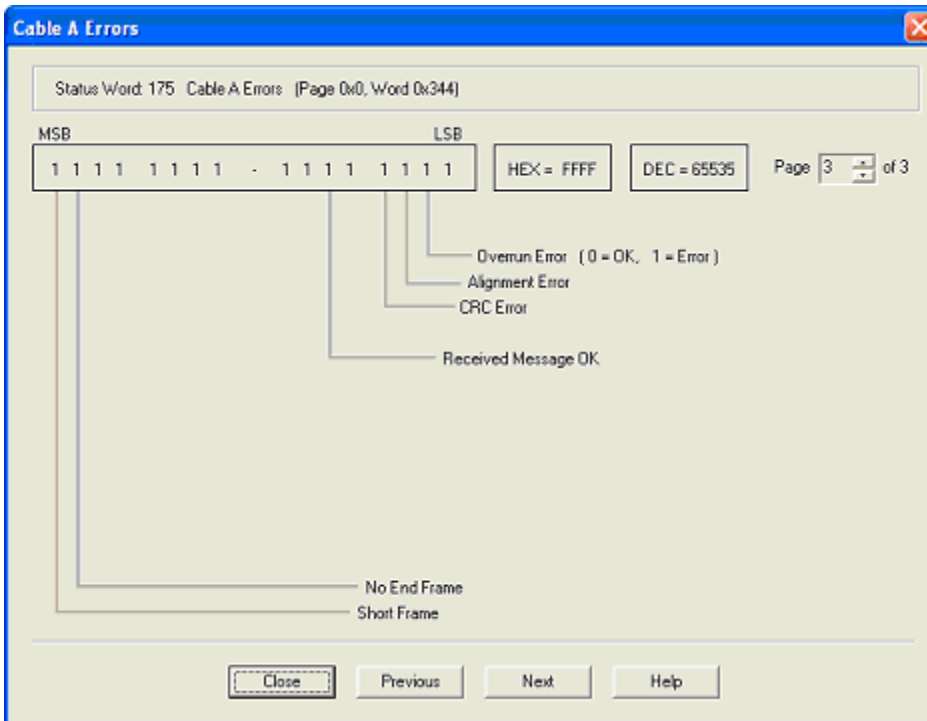

Status Word 175 is the last received LAN error code for cable A. The LAN hardware detected an error in receiving a message.

Cable B Errors

Cable B is the secondary or redundant cable connecting the Remote I/O Processor to the Remote I/O Interface (optional redundant cables).

To access the Cable B Errors dialog:

1. Access the **PLC Status** dialog by selecting the **PLC Utilities / PLC Status** menu item.
2. Click the **Cable B Errors** button. Screen 1 of 3 of the **Cable B Errors** dialog appears.

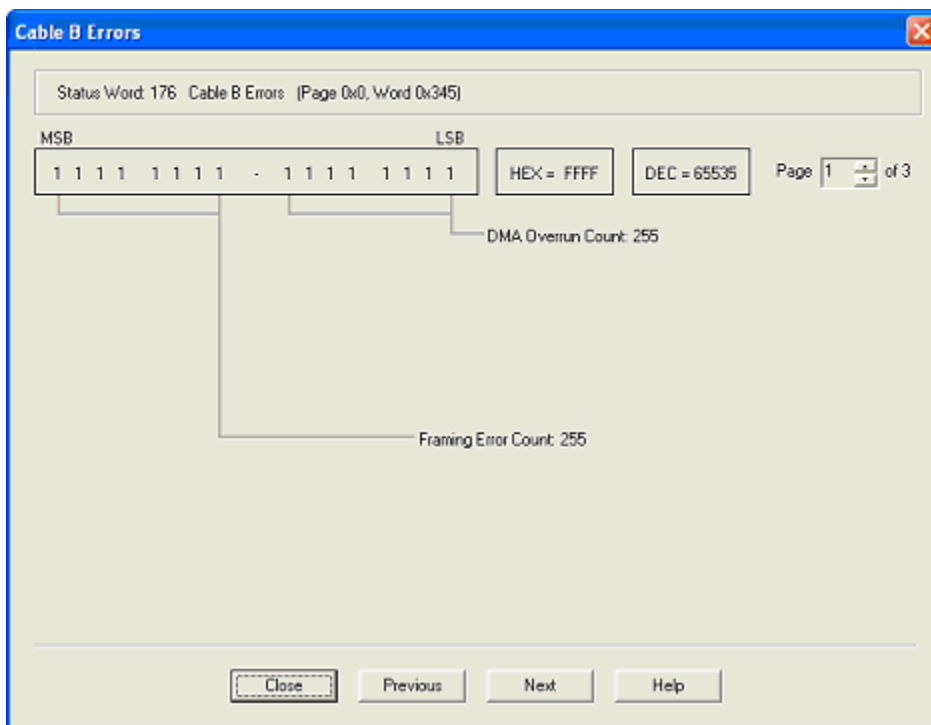

Status Word 176 is the count of frame size errors and DMA overrun errors. The high order byte represents a count of Cable B frame size errors. This indicates that the length of the data message was incorrect. The low order byte represents a count of DMA receiver overrun counts. This indicates that the hardware had more data to send than was required.

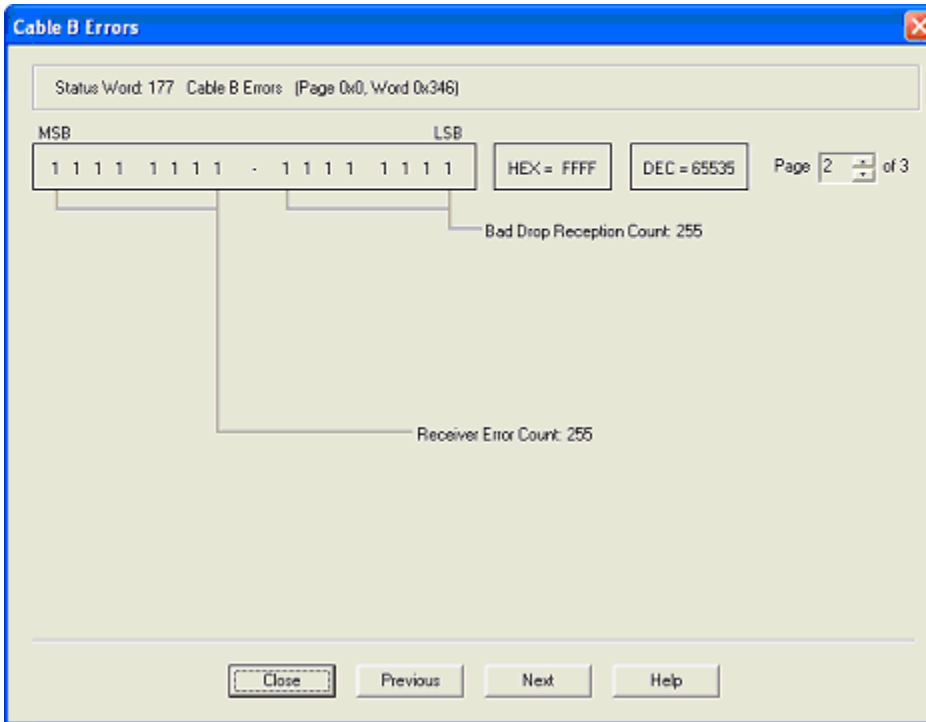

Status Word 177 is the Cable B LAN receiver error counter and the Bad Drop reception on cable B counter. This indicates a cable or noise problem to a drop. The “Drop Communication Errors (173)” should be examined to determine which drop is having problems.

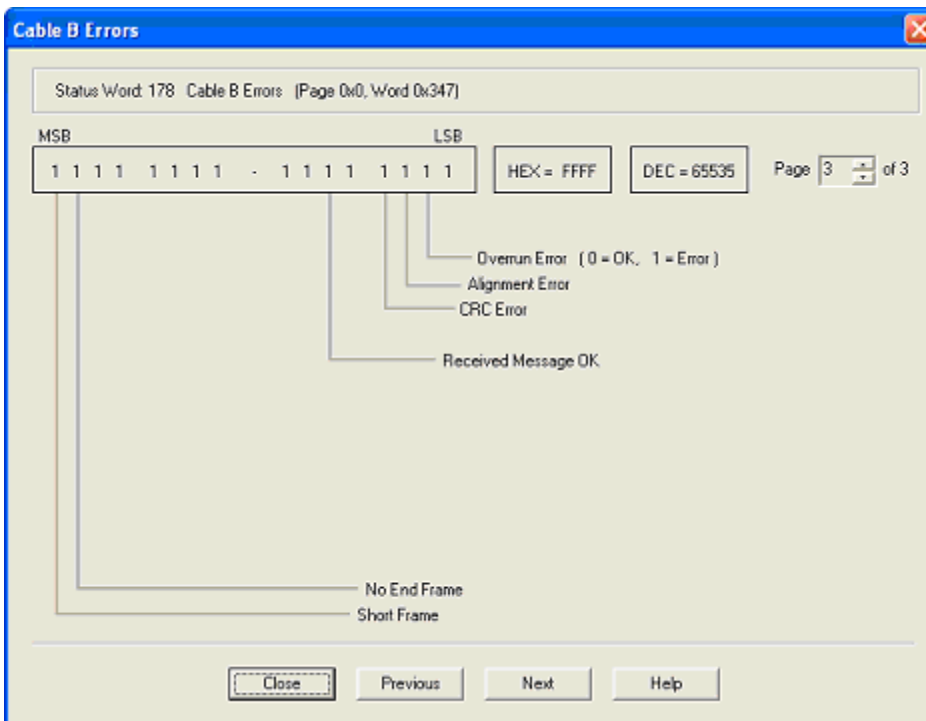

Status Word 178 is the last received LAN error code for cable B. The LAN hardware detected an error in receiving a message.

Global Errors

To access the Global Errors dialog:

1. Access the **PLC Status** dialog by selecting the **PLC Utilities / PLC Status** menu item.
2. Click the **Global Errors** button. Screen 1 of 3 of the **Global Errors** dialog appears.

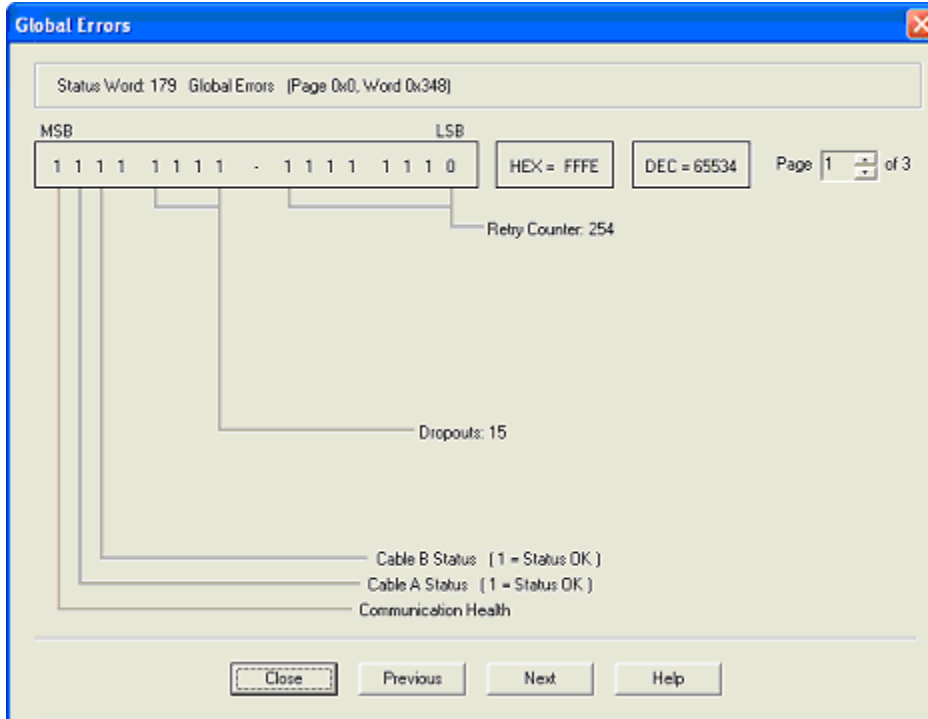

Status Word 179 shows the Global Communication Status. This word stores communications status for both cable A and cable B. Cable A is the main cable connecting the remote I/O Processor to the Remote I/O Interface. Cable B is the optional secondary or redundant cable. The specific information stored is shown in the following figure.

NOTE: It is possible for bits 2 and 3 to be '1' and bit 1 to be '0' "Cables (171)"

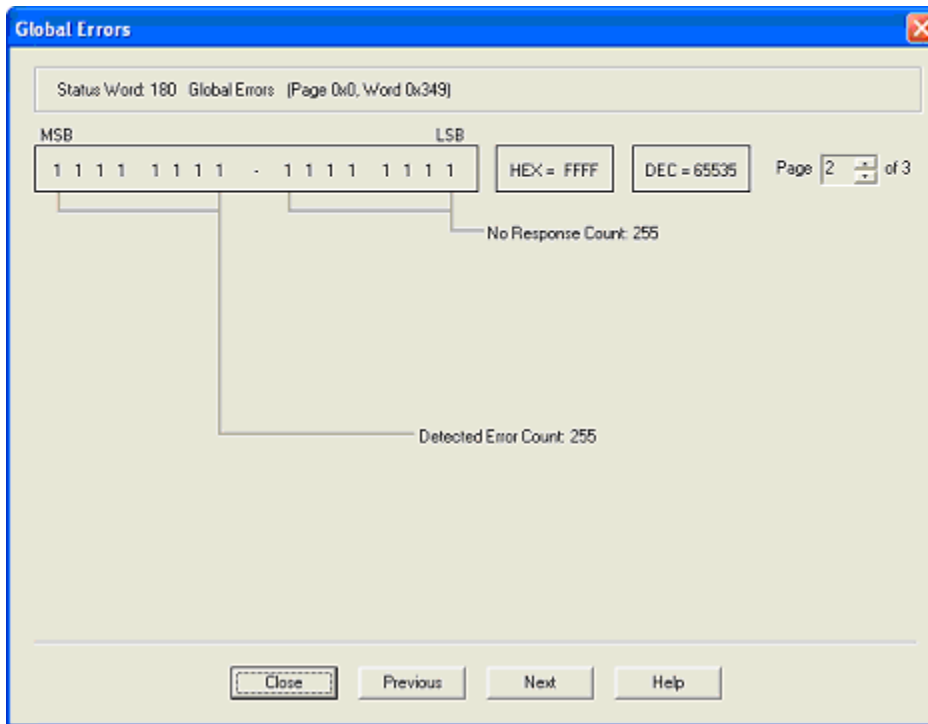

Status Word 180 is the Global Cumulative error counter for Cable A.

High byte - Framing error count / Low byte - No response count

Errors counted here cause the error counters in "Cable A Errors (168)" to increment.

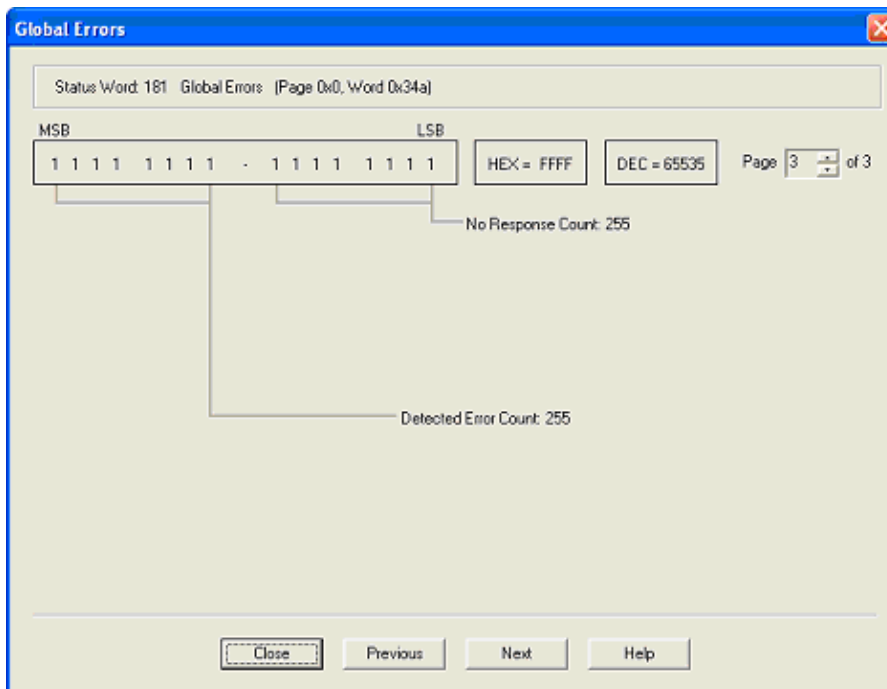

Status Word 181 is the Global Cumulative error counter for Cable B.

High byte - Framing error count / Low byte - No response count

Errors counted here cause the error counters in "Cable B Errors (169)" to increment.

Drop Communication Errors

Status Words 182 to 184 indicate the local drop communication errors status (when a local drop is present). The first drop may or may not be a local drop depending upon the controller type being used.

To access the Drop Communication Errors dialog:

1. Access the **PLC Status** dialog by selecting the **PLC Utilities / PLC Status** menu item.
2. Click the **Drop Communication Errors** button. Screen 1 of 3 of the **Drop Communication Errors** dialog appears.

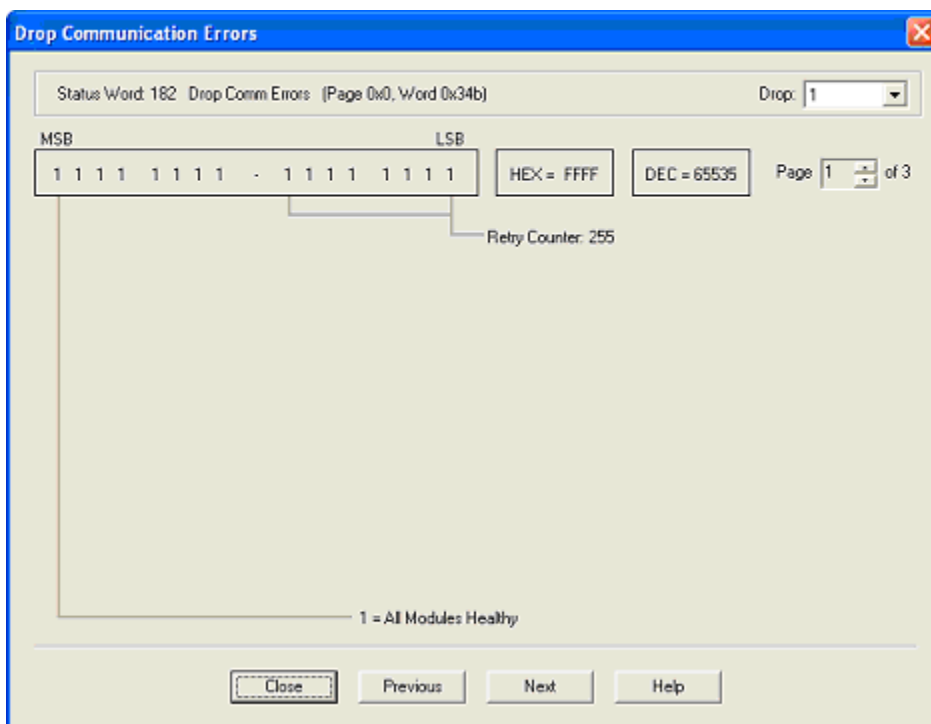

Status Word 182 indicates the overall health and retry counter for the local drop. If the MSB is not 1, there are “Module Health (166)” errors on the local drop.

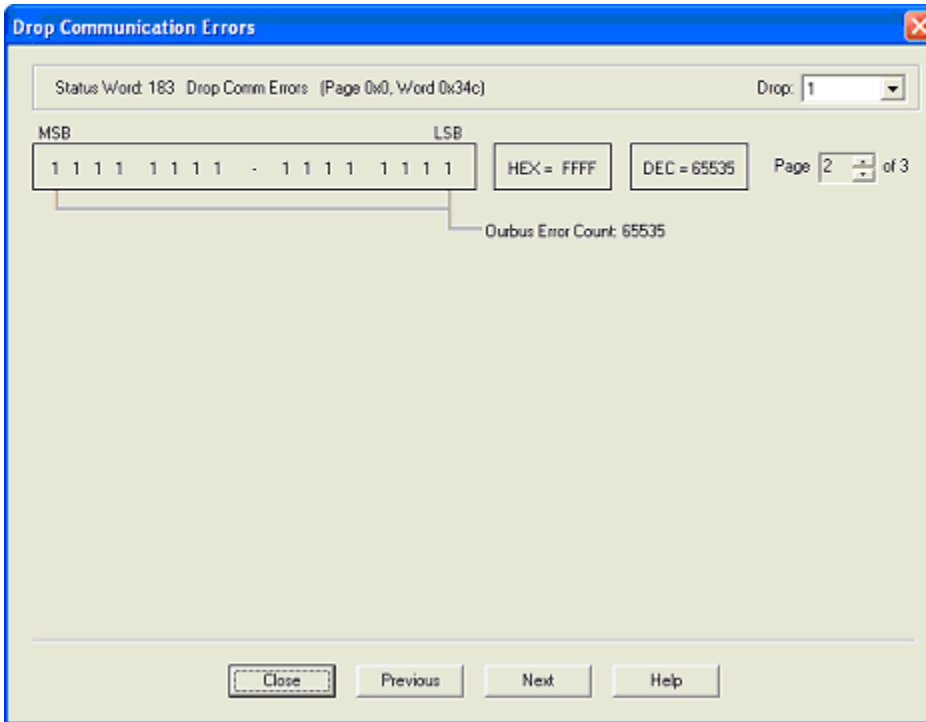

Status Word 183 shows the Ourbus error count for the local drop. If the count is incrementing, there are errors on the local drop. This may be caused by invalid information in the traffic cop, an unhealthy module in the local drop, or a mismatch between the traffic cop and the actual module in a slot located in the local drop.

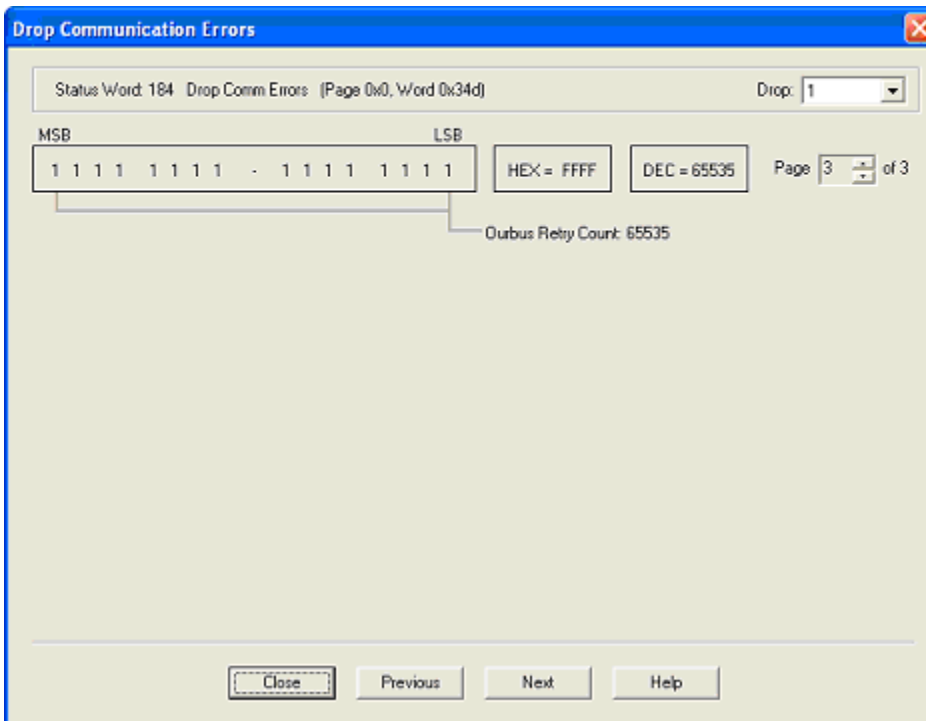

Status Word 184 indicates the Ourbus retry count for the local drop. The All Modules Healthy bit should be set under normal operating conditions.

DIO Health

To access the DIO Health dialog:

1. Access the **PLC Status** dialog by selecting the **PLC Utilities / PLC Status** menu item.
2. Click the **DIO Health** button. The **DIO Health** dialog appears.

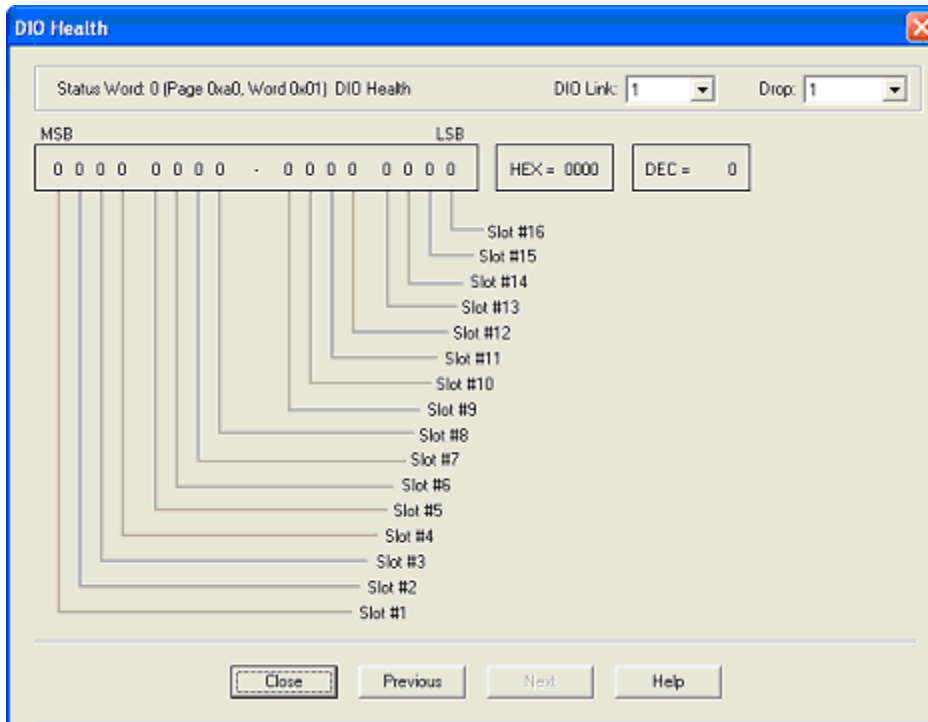

This status is available in the Quantum series controllers only.

The Distributed I/O Health block collects health information on a specified distributed I/O network.

The top node is a 4 digit constant that contains the head number and the starting drop. The first two digits indicate the head number. The following two digits contain the starting drop. The middle node contains the distributed I/O health starting at address 4xxxx. The bottom node contains the number of distributed I/O drop on which to collect health information.

The top output passes the power of the top input. The bottom output passes power when an invalid head or drop number is entered in the top node. Only a single network of distributed I/O can be accessed per DIOH block.

7 - Programming

Overview

In this chapter you will discover how to enter and modify logic using PLC Workshop's features. Remember, in the Windows environment there is usually more than one way to complete a task. PLC WorkShop provides keyboard support to access all commands. You may find that the most efficient method of programming will be through a combination of keyboard and mouse techniques.

Online versus Offline Programming

Before you begin programming, it is important that you understand the differences between programming online and programming offline.

While programming online you are connected to a PLC, which may be running. Changing logic in one network may affect logic in another network. These changes may create unexpected or hazardous results.

 Warning	Editing or modifying a program online may produce unexpected or hazardous results.
--	--

To indicate that the Node Editor is active, Node Edit appears on the left side of the title bar of each online logic program window. In the online mode, PLC Status and powerflow can also be displayed. However, some editing features are not available, including Cut, Paste, and Paste with Rewire.

How logic is validated and entered is the greatest difference between the two modes. The Node Editor (online) transfers logic immediately (when the cursor leaves the instruction) to the PLC after an instruction or address is inserted, replaced, or deleted. Offline, the entire segment is entered when you click Validate and Enter Logic from the Program menu or click the "check mark" button on the toolbar.

If you attempt to exit the Node Editor without transferring an edit to the processor, a warning message is displayed. The same is true if you attempt to exit a segment in offline mode without entering the changes.

Using the Logic Editor

The Logic Editor is where to begin programming since it allows you to display, access, and/or modify logic in the active logic program.

To access the Logic Editor:

1. Open or import a logic program.
2. Select the **View / Logic Editor** menu item or click the  toolbar icon. The **Logic Editor** dialog box appears.

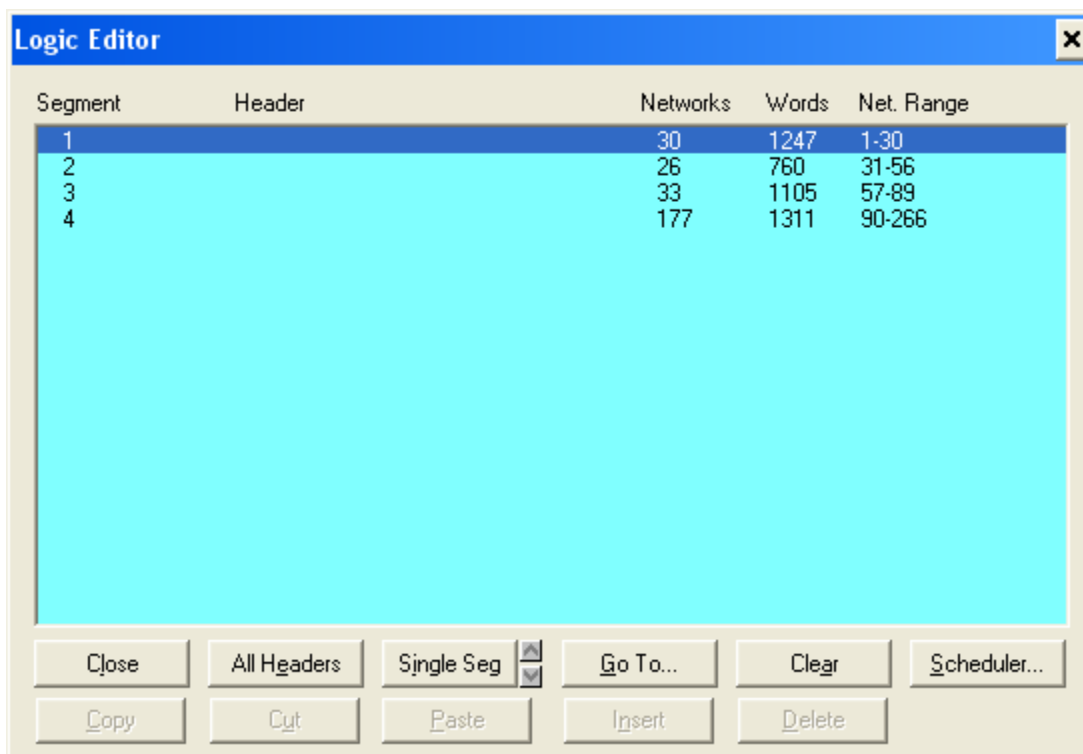

- Select a segment by clicking the segment number.
- Click the **All Headers** button to view all segment and network headers.
- Click the **Single Seg** button to view the networks in the selected segment.
- Click the **Go To...** button to display the selected segment in the Ladder Editor.
- Click **Clear** to clear logic from the selected segment.
- Click **Scheduler** to access the **Segment Scheduler** dialog.
- Click **Close** to close the Logic Editor and return to the active logic windows.

NOTE: The **Copy**, **Cut**, **Paste**, **Insert**, and **Delete** buttons are only enabled in the **All Headers** dialog.

Using the Segment Scheduler

The Segment Scheduler allows you to control the order and method of execution for each ladder segment. In addition, you can assign input and output drops to each segment to synchronize I/O scanning with ladder execution.

The B984 processor does not support the Segment Scheduler.

To access the Segment Scheduler:

1. Select the **View / Logic Editor** menu item.
2. Click **Scheduler** in the **Logic Editor** dialog. The **Segment Scheduler** dialog appears.

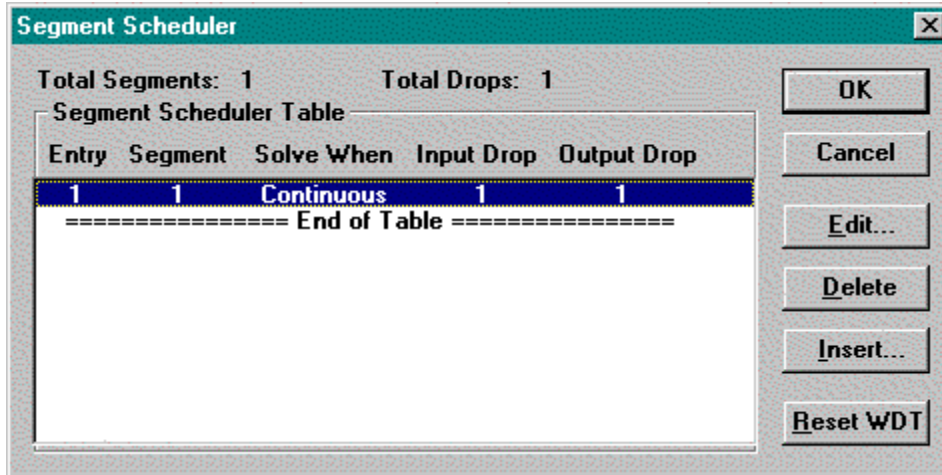

To edit an entry:

1. Select the desired entry in the **Segment Scheduler Table**, then click the **Edit** button. The **Edit** dialog appears.
2. Select the desired settings in the **Edit** box and click **OK** to enter the changes to the entry. Click **Cancel** to disregard edits to the entry and return to the **Scheduler**.

To delete an entry or entries:

Select the desired entry and click the **Delete** button. To select multiple entries hold down the [Shift] or [Ctrl] keys and click ([Shift]+Click or [Ctrl]+Click) or click, hold and drag across the desired entries in the **Segment Scheduler Table**, then click the **Delete** button. The selected entries are deleted.

To insert an entry:

1. With the cursor at the position you want to insert the new entry, click the **Insert** button. The **Insert** dialog appears.
2. Enter the desired information in the Insert box and click **OK** to insert the entry. Click **Cancel** to disregard the entry information and return to the Scheduler.

NOTE: When the **Insert** or **WDT** (see below) buttons are clicked, a check for available table entries is conducted. If information exists for all 32 entries a warning message appears stating that the maximum number of entries exists.

3. To insert a **Reset Watchdog Timer**, click the **WDT** button. A **Reset Watchdog Timer** is inserted at the position of the cursor. Please note; you cannot have consecutive Reset Watchdog Timers.
4. Click **OK** to enter your changes in the Segment Scheduler. Click **Cancel** to disregard all changes to the Segment Scheduler and return to the Logic Editor.

Using the Ladder Editor

Several logic program windows can be displayed simultaneously. However, one window is active at one time. In the active logic window, the ladder editor allows you to enter and modify ladder logic.

To make a logic window active, simply place the pointer on the desired window and click the left mouse button. From the keyboard, press [Alt+W] and press the number of the corresponding logic window. You will notice that the active window comes to the front of all other windows.

Insert a New Network

In the active logic program window you can insert a new network using the mouse or the keyboard.

To insert a new network using the mouse:

1. Click the  toolbar icon. Notice that the new network attaches to the pointer.
2. Bring the pointer into the active logic window. Position the pointer where you want the new network.
3. Click the left mouse button. The new network is inserted. If the new network is inserted on existing Network 002, for example, the new network becomes Network 002 and existing Network 002 becomes 003.
4. Repeat Step 3 to insert additional networks.
5. Remove the new network from the pointer by clicking the arrow on the **Instruction Bar**.

To insert a new network using the keyboard:

1. Press [Alt+P] and the **Program** menu drops down.
2. Press [N] or use the down arrow key to highlight **New Network** and press [Enter]. The **New Network** dialog appears.
3. Enter the number of the network you wish to enter. If a network 002 exists and you enter 2 in the **Network Number** box, the existing Network 002 becomes Network 003 and the new network becomes 002.
4. Press [Enter] and the new network is inserted.
5. Repeat Step 3 to enter additional networks.

Append a New Network

In the active logic program window you can append a new network using the mouse or the keyboard.

To append a new network using the mouse:

1. Click the  toolbar icon. Notice that icon attaches to the pointer.
2. Bring the pointer into the active logic window. Position the pointer where you want to append a new network.
3. Click the left mouse button. The new network is appended. If the new network is appended on existing Network 002, for example, the new network becomes 003.
4. Repeat Step 3 to append additional networks.
5. Remove the new network from the pointer by clicking the arrow on the **Instruction Bar**.

To append a new network using the keyboard:

1. Press [Alt+P] and the **Program** menu drops down.
2. Press [A] or use the down arrow key to highlight **Append New Network** and press [Enter]. The **New Network** dialog appears.
3. Enter the number of the network you wish to enter. If the new network is appended on existing Network 002, for example, the new network becomes 003.
4. Press [Enter] and the new network is appended.
5. Repeat Step 3 to enter additional networks.

Insert a New Row

You can insert a new row to a network similar to inserting a new network. In the active logic program window, use the mouse or keyboard to place the cursor on an existing row in the network.

To enter a new row using the mouse:

1. Click the  toolbar icon. Notice that the new row attaches to the pointer.
2. Place the pointer in the position where you want the new row to appear.
3. Click the left mouse button and the new row is inserted.
4. Repeat Step 3 to insert additional rows.
5. Remove the new row from the pointer by clicking the arrow on the **Instruction Bar**.

To insert a new row using the keyboard:

1. Press the **Insert** key to turn the **Ins** mode on. See the **Status Line** near the bottom of the screen.
2. Use the arrow keys to position the parameter cursor (red or highlighted box) in the last row of the network.
3. Press [Enter] and the new row appears as the last row.
4. Repeat Step 3 to enter additional networks.

Entering Ladder Instructions

Entering Instructions Using the Mouse and Instruction Bar

To enter instructions using the mouse and Instruction Bar:

1. Move the pointer to the **Instruction Bar**.
2. Click with the left mouse button on the desired instruction on the lower half of the Instruction Bar. If the desired instruction is not displayed, click the appropriate instruction group on the top half of the instruction bar.
3. Move the pointer over the logic program. Notice that the instruction is attached to the pointer.
4. Position the pointer where you wish to place the instruction.
5. Click the left mouse button, and the instruction is placed in that location. If an instruction cannot be placed in that location, an error message is displayed.

6. If the **sticky cursor** has been turned on in the **Program Setup** under **General**, the instruction will remain attached to the pointer. Click the left mouse button once for each additional instruction you want to insert. To remove the instruction from the pointer, click the toolbar icon (Selection cursor) that looks identical to the mouse pointer.
7. If the **sticky cursor** has not been turned on in the **Program Setup** then after the instruction has been dropped into place, the pointer returns to an arrow.

Entering Ladder Instructions Using Mnemonics

To enter Ladder Instructions using Mnemonics:

1. In the active logic program, position the cursor (by using the arrow keys) where the instruction is to be located.
2. Type in the instruction mnemonic at the cursor location and press [Enter]. If you forget an instruction mnemonic just enter a [?] and press [Enter]. The following mnemonic pick list will be displayed. Pick the mnemonic you desire by double clicking on the mnemonic or arrow to the mnemonic and press [Enter]. The mnemonic pick list will also display if an illegal mnemonic is entered.

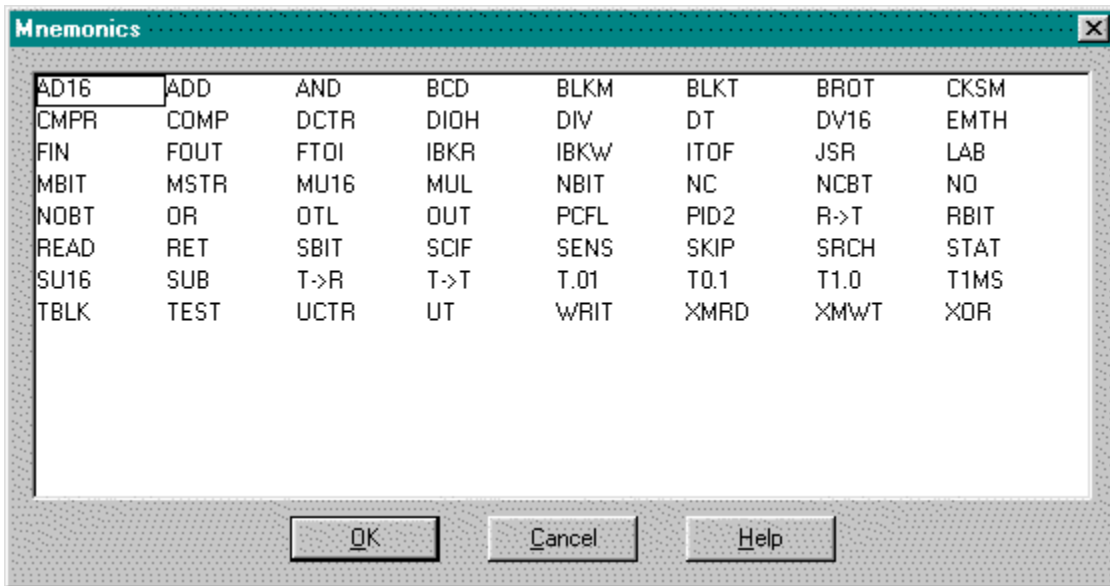

3. The following is a list of all Modicon ladder instruction mnemonics:

Mnemonic	Instruction
AD16	16-BIT ADDITION
ADD	ADDITION
AND	This function performs a logical AND operation.
BCD	Converts registers from Binary to BCD or BCD to Binary.
BLKM	Block Move Function
BLKT	BLOCK TO TABLE MOVE

BMDI	Block move between normal logic and an interrupt subroutine.
BROT	BIT ROTATE
CALL	The Call instruction activates an immediate or deferred DX function from a library of functions defined by function codes.
CKSM	CHECKSUM
COMM	The ASCII Communications Function
CMPR	Compare
COMP	Logical Complement function. When this function is performed, a matrix is complemented.
CONV	Convert Block
CTIF	The Interrupt/Timer/Counter function
DCTR	Down Counter
DIOH	DIOH copies the module health for distributed drops to 4x registers.
DISA	Disabled Monitor System
DIV	Division
DMTH	Double Precision Math
DRUM	Drum block
DT	Transitional (On To Off) Contact.
DV16	16-Bit Division
EARS	Ears loadable.
EMTH	Extended Math.
EUCA	The Engineering Unit Conversion
FIN	First-In Move Function.
FN10	The FN10 custom loadable is used to communicate to the MMC188/40.
FOUT	First-Out Move Function.
FTOI	Floating point-to-signed/unsigned integer conversion.
HIST	The Discrete Logic Analyzer/Histogram
HLTH	The 984 Health Status.
HSBY	The Hot Standby Loadable (HSBY) is a loadable DX function that manages a Hot Standby control system.
IBKR	Indirect Block Read will indirectly copy

	registers to another block.
IBKW	Indirect Block Write will indirectly copy working registers to individual registers.
ICMP	Input Compare compares bit for bit the feedback data of live inputs to the expected status of each point in its table.
ID	Interrupt Disable block
IE	Interrupt Enable block
IMIO	Immediate I/O block
IMOD	IMOD Interrupt Module Vectors
ITMR	Interval Timer Interrupt block
ITOF	Signed/unsigned integer-to-floating point conversion
JSR	Jump to subroutine
LAB	Description the starting point of a subroutine
LOAD	LOAD block loads a block of 4x registers (previously SAVED) from state RAM where they are protected from unauthorized modification.
MAP3	The MAP3 function block allows the 984 controller to initiate communications with MAP network nodes.
MATH	MATH function
MBIT	Modify Bit
MBUS	The MBUS loadable function is used with the S975 module to initiate a single transaction with another device on the Modbus II network
MRTM	The multi-register transfer module (MRTM)
MSTR	Master Block Instruction
MU16	16-Bit Multiplication
MUL	Multiplication
NBIT	Normal Bit sets the specified register bit to the input power state.
NC	Normally Closed Contact
NCBT	Normally Closed Bit
NO	Normally Open Contact
NOBT	Normally Open Bit

OR	The OR function performs a logical OR operation on two matrices.
OTL	Latch Coil
OUT	Coil
PCFL	Processor Control Function Library
PEER	The PEER loadable function is used with the S975 module to initiate identical message transactions with as many as 16 devices on the ModbusII network at one time.
PID	Analog loop control provides negative feedback (closed loop) control of a measured process condition, in order to eliminate error conditions.
PID2	PID2 analog loop control.
R °T	Register->Table Move Function
RBIT	Reset Bit clears the specified bit of a 4X register.
READ	READ data from an ASCII device.
RET	Return From Subroutine
RTTI	Register to Input Table block
RTTO	The Register to Output Table block
SAVE	SAVE block saves a block of 4x registers to state RAM where they are protected from unauthorized modification.
SBIT	Set Bit sets a specified register when input power is "ON".
SCIF	SCIF is a sequential control interface function block.
SENS	The SENSE function examines and reports the state of individual bits in a matrix.
SKIP	SKIP will skip logic in a group of networks.
SRCH	Search for a specified value in a table of registers.
STAT	System Status
SU16	16-Bit Subtraction
SUB	Subtract
SWAP	SWAP block allows the user to issue one of three different swap commands.

T°R	Table -> Register Move Function
TTR	The Table to Register block
T°T	Table -> Table Move Function
T.01	TIMERS – T.01 a timer with a .01 second time base.
T1.0	TIMERS - T1.0 a timer with a 1.0 second time base.
T0.1	TIMER – T0.1a timer with a 0.1 second time base.
T1MS	The millisecond timer (T1MS) increments at intervals of 1 ms.
TBLK	Table-to-Block Move moves a block of holding registers from a block in a source table to a destination block in one scan.
TEST	16-Bit Magnitude Comparison (Test)
UCTR	Up Counter
UT	Positive Transition Contact.
VMER	VME Read block allows the user to read data from devices on the VME bus.
VMEW	VME Write block allows the user to write data to devices on the VME bus.
WRIT	WRITE data to an ASCII device.
XMRD	Extended Memory Read Function
XMWT	Extended Memory Write Function
XOR	Exclusive Or

PLC WorkShop for Modicon – 32 incorporates use of various function key alternatives and CTRL/ALT functions.

Windows Default Hot Keys

The following Windows Default hot keys can be automatically used:

Windows Default Hot Key	Function
Ctrl A	Select All
Ctrl C	Copy
Ctrl D	DX Zoom Screen
Ctrl F	Find
Ctrl L	Edit Documentation Window

Ctrl N	New Program
Ctrl O	Open Program dialog box
Ctrl P	Print
Ctrl S	Save Program
Ctrl T	Transfer Offline to Online.
Ctrl U	Address Used
Ctrl V	Paste
Ctrl X	Cut
Ctrl Z	Undo Changes
F1	Help
F3	Insert Network
F8	Validate and Enter
F9	Branch Down
F10	Activate Menu
DEL	Clear current element
END	Moves to last column/row 1 of current rung
ENTER	Edit: moves to next row, current rung, or to next rung Display: moves to next row or rung
ESC	Deletes current address and put you into edit mode for address
Shift F2	Trace Coil
Shift F3	Untrace Coil
TAB	Deletes current address and put you into edit mode for address
? or \	List mnemonics for current field
HOME	Moves to column 1, row 1 of current rung
-	Draws horizontal line
PgUp	Page Up
PgDn	Page Down
Ctrl L	Edits synonym/descriptor

WorkShop DOS Hot Keys

The following WorkShop DOS hot keys can be used. To enable use:

1. Select the **Options / Program Setup** menu item.
2. Select the **Logic** tab.
3. Select Options for General.
4. Within the Hot key options field, select FasTrak/GraySoft DOS.
5. Click **OK**.

6.

WorkShop DOS Hot Key	Function
Alt P	Print
Alt D	Data Screen
Alt V	Data Screen
Alt W	Modify Documentation
Alt H	Edit Headers
Alt L	Toggle Labels off and on
Alt R	Address Used
Alt Z	DX Zoom Screen
F1	Normally Open Contact
F2	Normally Closed Contact
F3	Coil
F4	Help
F5	Insert
F8	Horizontal Short
F9	Vertical Branch
F10	Validate and Enter

Modsoft Hot Keys

The following Modsoft hot keys can be used. To enable use:

1. Select the Options / Program Setup menu item.
2. Select the **Logic** tab.
3. Select **Options for General**.
4. Within the **Hot key options** field, select **Modsoft**.
5. Click **OK**.

Modsoft Hot Key	Function
/	Normally Closed Contact
" or ´	Normally Open Contact
or F9	Vertical Branch
=	Horizontal Short
[or (Coil
F2	Edit mode for address
F3	Insert Row

Memory Usage

Coils Used

To determine which coils are used and which are unused:

1. Click the **View / Coils Used** menu item or press [Alt+V, C]. The **Coils Used** dialog appears.

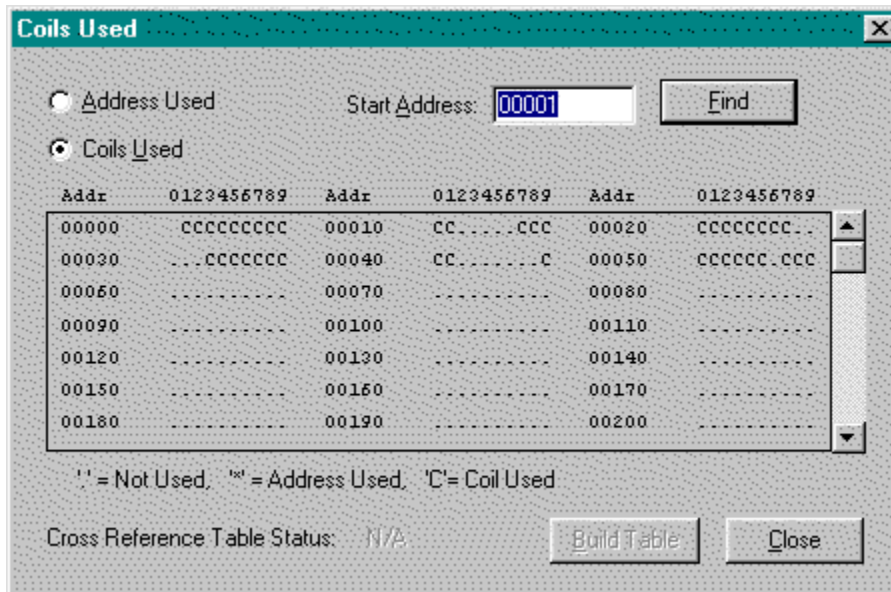

2. Click the **Used** radio button to view the used coils.
3. Click the **Unused** radio button to view the unused coils.
4. Enter the starting address to begin the search and click the **Find** button.
5. If a coil is used it is noted with a "C". If it is not used it is noted with a ".".
6. Click **Close** to close the **Coils** dialog and return to the active logic program.

Address Used

To determine which addresses are used and which are unused:

1. Click the **View / Address Used** menu item or press [Alt+V, U]. The **Coils** dialog appears.
2. Click the **Address Used** radio button to view the used address.
3. Enter the starting address to begin the search and click the **Find** button.
4. If an address is used it is noted by an “*”. If it is not used it is noted by an “.”.
5. Click **Close** to close the **Coils** dialog and return to the active logic program.

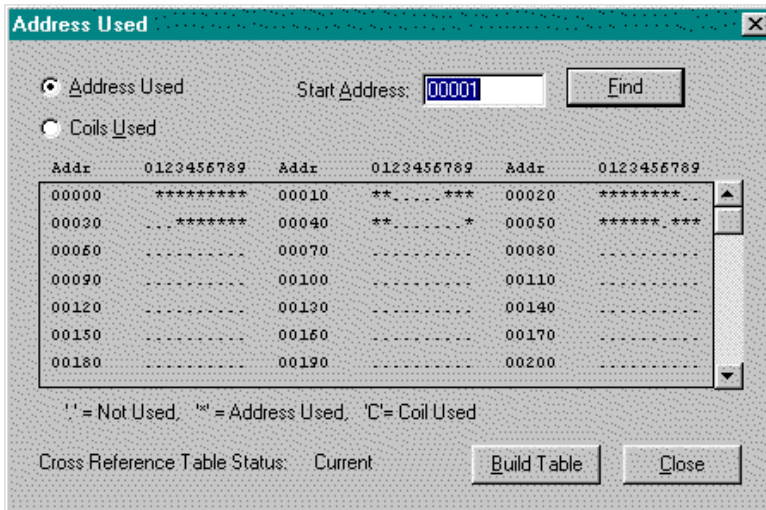

Using the ASCII Message Editor

The ASCII Message Editor gives you the ability to program and playback ASCII messages.

To access the ASCII Message Editor:

1. Click the **View / ASCII Message Editor** menu item or press [Alt+V, A]. The **ASCII Message Editor** dialog appears.

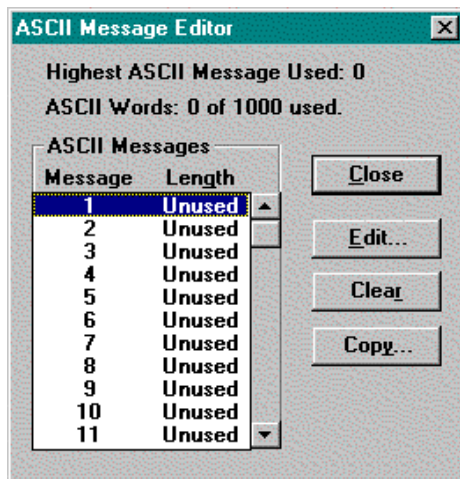

2. Click **Close** to return to the active logic window.

To edit ASCII messages:

1. Click or use the arrow keys to highlight the desired message.
2. Click the **Edit** button on the right side of dialog. The **Edit** dialog appears.

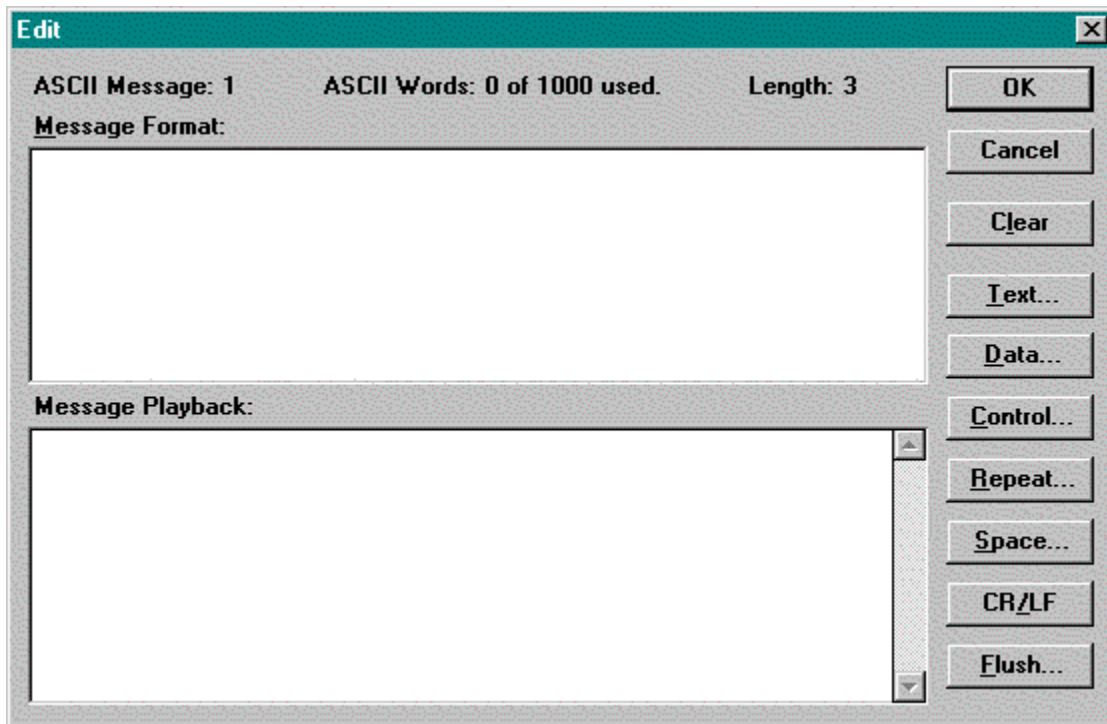

3. Click **OK** to enter your changes to the ASCII messages and return to the **ASCII Message Editor** dialog. Click **Cancel** to disregard your changes and return to the **ASCII Message Editor**.

The **Message Format** box on the top half of the **Edit** dialog displays the selected ASCII message. You can edit the message in this area. The **Message Playback** dialog on the lower half of the **Edit** dialog displays the selected ASCII message as it will appear on the target ASCII device. Each time an edit is performed in the **Message Format** box, the **Message Playback** box is updated.

The following option buttons are available in the **Edit** dialog.

Text

Click the **Text** button in the **Edit** dialog to enter an ASCII text string in the **Text** dialog. Click **OK** to enter a new field in the **Message Format** box. If the text will cause the message to exceed 134 words, an error message appears advising you that the message cannot be inserted.

Example:

Enter the following ASCII text string in the **Text** dialog:

'This is a text string'

The following will subsequently appear in the **Message Playback** box of the **Edit** dialog:

This is a text string

Data Format

Click the **Data** button on the right side of the **Edit** dialog to allow you to enter a data value in the **Data** dialog.

Select the desired data format and click **OK** to insert the new field. If the data format causes the message to exceed 134 words an error message is displayed.

Example:

Data Format	Text Entered	Appears in Message Playback
Integer	3I4	IIIIIIIIIIII
Integer With Leading Zeros	2L8	LLLLLLLLLLLLLLLL
Binary	2B3	BBBBBB
Octal	3O5	OOOOOOOOOOOOOO
Hexadecimal	3H2	HHHHHH
ASCII	8A	AAAAAAAA

Control Code

Click **Control** in the **Edit** box to allow you to enter a control code in the **Control Code** dialog box. The control code is a value between 0 and 255. Click **OK** to insert the new field. If the **Control Code** causes the message to exceed 134 words an error message is displayed.

Example:

Enter this Control Code	Appears in Message Playback
174	

Repeat

Click **Repeat** in the **Edit** box to allow you to enter a repeat count in the **Repeat** dialog box. Enter the repeat count; see example. Click **OK** to insert the repeat count. If the repeat count causes the message to exceed 134 words an error message is displayed. Nesting repeats is not a valid ASCII message.

Example:

Enter this Repeat count	Appears in Message Playback
3 ()	Fields inserted between the parentheses are repeated 3 times.

Space

Click **Space** in the **Edit** box to enter a space count in the **Space** dialog box. Enter the space count; see example. Click **OK** to insert the space count. If the space count causes the message to exceed 134 words an error message is displayed.

Example:

Enter this Space count	Appears in Message Playback
20X	20 spaces are displayed.

CR/LF

Click **CR/LF** in the **Edit** box to position the next field on the left side of the next row. If **CR/LF** causes the message to exceed 134 words an error message is displayed.

Flush

Click **Flush** in the **Edit** box to enter a flush buffer in the **Flush** dialog box. Select the desired flush buffer. Click **OK** to insert the flush buffer. If the flush buffer causes the message to exceed 134 words an error message is displayed.

Example:

Enter these values in Flush box	Appears in Message Playback
Flush Buffer: Yes	Nothing is displayed in the playback
Flush Number of Bytes: 20	box for these fields.
Flush Until Match: 100	
Flush Thru Match: 50 to 10	

Clear {Edit box}

Click **Clear** in the **Edit** box to clear the selected message or messages.

In addition to **Edit**, the following are the other option buttons available in the ASCII Message Editor:

Clear {ASCII Message Editor box}

Click **Clear** to clear the **Message Format** and **Message Playback** boxes.

Copy

Click **Copy** to allow you to, via the **Copy** dialog box, copy the currently selected ASCII message to another ASCII message. If the destination to which you are copying the message exists an error message appears, stating the message exists and will be overwritten. Click **OK** to copy the message. Click **Cancel** to return to the ASCII Message Editor.

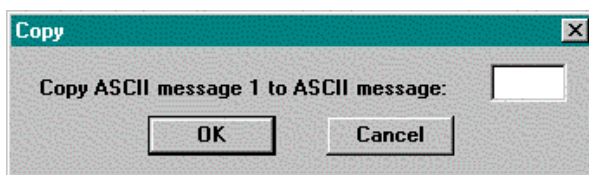
**Close**

When you are finished editing the ASCII messages, click **Close** in the ASCII Message Editor to return to the active logic window.

Finding Logic

Use **Ladder Find** to perform the following Search functions:

Search for a network

Search for a ladder item or reference number

Search for a specific ladder item with a specific reference number

Search for a symbol with or without an address

Find a Network

1. Select the **Edit / Find** menu item or click the  toolbar icon. The **Find** dialog appears.

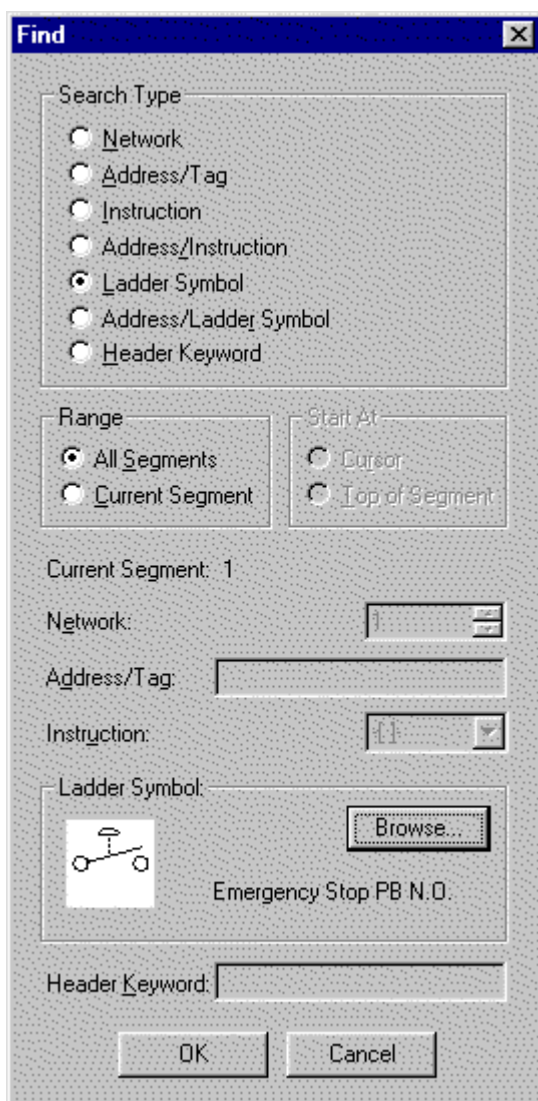

NOTE: If **Continuous** is selected (in **Program Setup** under **Network Number Mode**), networks can be found in consecutive order across segment boundaries. When **By Segments** is selected networks are found based on segments, with the first network in each segment starting with one.

2. Click the **Network** radio button.
3. In the **Network** selection box, type the number of the network you wish to find. If there are 5 networks in the segment, you can only enter a number from 1 to 5.
4. Click the desired option in the **Start At** box.
5. Click **OK** to begin the search. If the item is found, the **Find** dialog disappears, and the cursor moves to the located item.
6. Click **Cancel** to disregard the search and return to the active logic program.

Find an Address or Tag

1. Select the **Edit / Find** menu item or click the  toolbar icon. The **Find** dialog appears.
2. Click the **Address/Tag** button.
3. In the **Address/Tag** text box, type the address or tag you wish to find.
4. In the **Range** box, identify the range of segments you want to search. Choices include **All Segments** and **Current Segment**.
5. Click the desired option in the **Start At** box. If you selected **All Segments** in the **Range** box, the **Start At** box is unavailable.
6. Click **OK** to begin the search. If the item is found, the **Find** dialog disappears, and the cursor moves to the located item.
7. Click **Cancel** to disregard the search and return to the active logic program.

Find a Ladder Symbol

1. Select the **Edit / Find** menu item or click the  toolbar icon. The **Find** dialog appears.
2. Click the **Ladder Symbol** radio button.
3. In the **Range** box, identify the range of segments you want to search. Choices include **All Segments** and **Current Segment**.
4. Click the desired option in the **Start At** box. If you selected **All Segments** in the **Range** box, the **Start At** box is unavailable.
5. Click the **Browse** button to launch the **Symbol Library Pick** window. Within this window, choose the symbol desired.
6. Click **OK** to begin the search. If the item is found, the **Find** dialog disappears, and the cursor moves to the located item.
7. Click **Cancel** to disregard the search and return to the active logic program.

Find a Ladder Item

1. Select the **Edit / Find** menu item or click the  toolbar icon. The **Find** dialog appears.
2. In the **Search Type** field, select the **Instruction** radio button.
3. In the **Instruction** drop-down box, select the item to be searched for.
4. In the **Range** box, identify the range of segments you want to search for. Choices include **All Segments** and **Current Segment**.
5. Click the desired option in the **Start At** box. If you selected **All Segments** in the **Range** box, the **Start At** box is unavailable.
6. Click **OK** to start the search.

Find an Address/Tag and Instruction

1. Select the **Edit / Find** menu item or click the  toolbar icon. The **Find** dialog appears.
2. Click the **Address/Instruction** radio button.
3. In the **Address/Tag** text box, type the address or tag you wish to find.
4. In the **Instruction** drop-down box, select the item to be searched for.
5. In the **Range** box, identify the range of segments you want to search for. Choices include **All Segments** and **Current Segment**.
6. Click the desired option in the **Start At** box. If you selected **All Segments** in the **Range** box, the **Start At** box is unavailable.
7. Click **OK** to begin the search. If the item is found, the **Find** dialog disappears, and the cursor moves to the located item.
8. Click **Cancel** to disregard the search and return to the active logic program.

Find Keyword String in a Header

1. Select the **Edit / Find** menu item or click the  toolbar icon. The **Find** dialog appears.
2. Click the **Header Keyword** radio button.
3. In the **Header Keyword** text box, type the **Header** text string you wish to find.
4. Click **OK** to begin the search. If the item is found, the **Find** dialog disappears, and the cursor moves to the located item.
5. Click **Cancel** to disregard the search and return to the active logic program.

Find Next

Select the **Edit / Find Next** menu item or click the  toolbar icon to find the next occurrence of an address or tag.

Find Previous

Select the **Edit / Find Previous** menu item or click the  toolbar icon to find the previous occurrence of an address or tag.

Trace Coil and Untrace Coil

Trace Coil

The Trace Coil feature allows the user to find the coil of a selected address more quickly than with the **Find** feature. The Trace Coil operation searches the ladder for the coil whose address matches the selected address. When found, the section of logic that contains the coil is displayed. Counterpart coils may also be displayed in Ladder beneath the contact instruction. (See *Displaying Traced Coils in Ladder*.)

To locate the coil of an address:

1. Place the ladder cursor on an address in the ladder.
2. Select the **Diagnostics / Trace Coil** menu item, press the hot-key combination [**Shift-F2**], or select **Trace Coil** from the right-click menu. The **Trace Coil** and its companion **Untrace Coil** items appear.

NOTE: The ladder cursor must be positioned over an address for the **Trace Coil** feature to operate. If the ladder cursor is not positioned on an address, the hot-key combination [**Shift-F2**] will not operate and the **Trace Coil** menu items are disabled.

A rolling list of the ten most recent traces is maintained. The logic containing the coils in any of these previous traces can be displayed.

Untrace Coil

The Untrace Coil feature can redisplay any of the previous traces up to ten.

To locate the coil found in a previous trace:

1. Select the **Diagnostics / Untrace Coil** menu item, press the hot-key combination [**Shift-F3**] or select **Untrace Coil** from the right-click menu. The **Untrace Coil** dialog below appears.

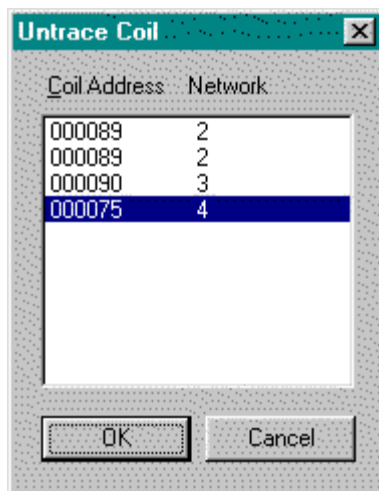

The list box in this dialog contains the addresses of up to ten previous traced coils. It is a rolling list of the last ten traces. When an eleventh coil is traced, the first coil in the list is removed. Then coils 2 through 9 are moved up the list by one line. Finally, the eleventh coil is added as the tenth item in the list.

To redisplay the ladder logic in which one of the coils is located, double-click the coil address in the list box or highlight the coil address and click OK.

NOTE: Previous trace operations must have been performed and held in the history list for the **Untrace Coil** feature to operate. If there are no items in this list, the hot-key combination [**Shift-F3**] will not operate and the **Untrace Coil** item on the right-click menu is disabled.

Displaying Traced Coils in Ladder

As an alternative to locating address coils in the Cross Reference listing, they may be displayed in the ladder logic beneath each corresponding contact instruction. To enable this feature select the **Diagnostics / Display Traced Coils** menu item.

When **Display Traced Coils** is enabled, the **Segment** and **Network** numbers in which the counterpart coil is located appear within brackets beneath the contact instruction.

In the following example, Segment 1 Network 2 contains a contact with address 000002. The counterpart coil to this contact is located in Segment 3 Network 8.

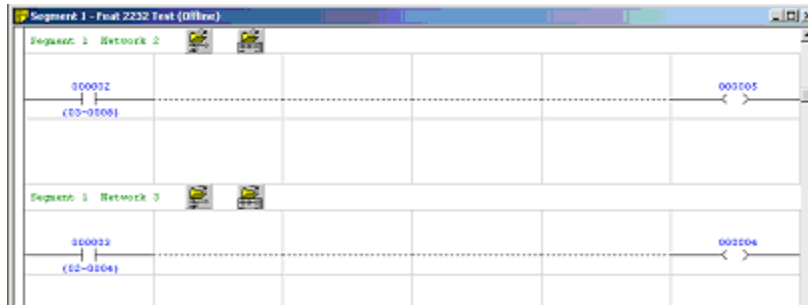

Since the Segment and Network numbers shown by the **Display Traced Coils** feature originate from the **Cross Reference** table, the traced coil information is only as current as the last time the table was built. If the program's Cross Reference table is not up-to-date, when **Display Traced Coils** is turned on, the following update message appears providing the opportunity to rebuild the Cross Reference table and make the Display Traced Coils information as complete as possible.

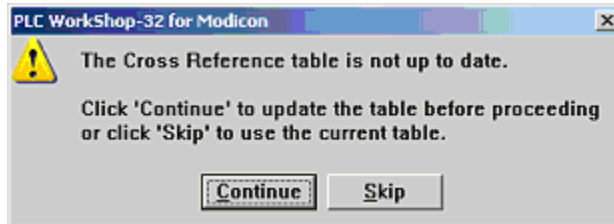

NOTE: The forced state of the Discrete displays next to the coil trace.

Using the Data Window

The Data Window menu item opens a new window and allows you to view and change the data values of your program.

Once you display addresses in the Data Window, you can enter specific values. If monitoring data online, you can enter a value for a particular address and send it directly to the processor.

You can also create tables of addresses, store them on a disk, and transfer them to the PLC at a later time.

1. With a logic program open, select the **View / Data Window** menu option or click the  toolbar icon. The **Data Window** dialog appears. Use the **Option / Program Setup** menu item or the right mouse menu to change which columns are displayed in the **Data Window**. See *Program Setup* in Chapter 4.

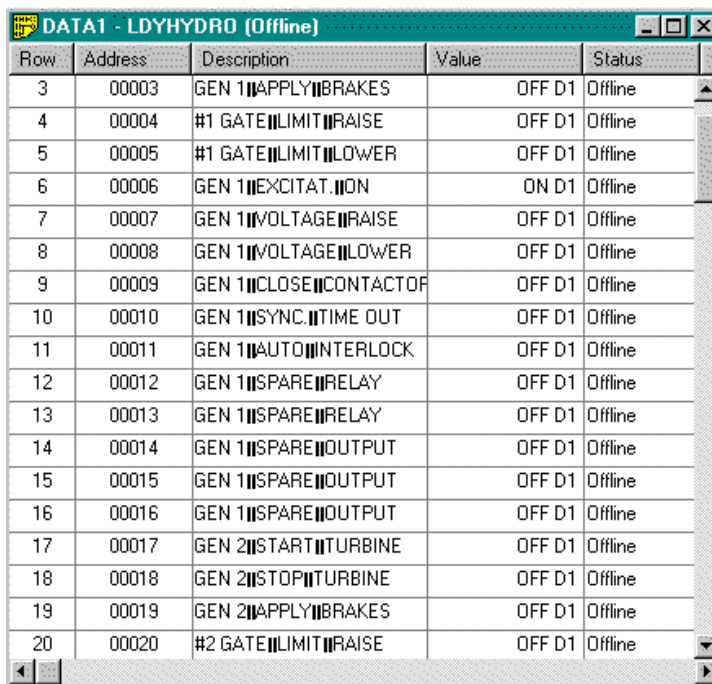

Row	Address	Description	Value	Status
3	00003	GEN 1 APPLY BRAKES	OFF D1	Offline
4	00004	#1 GATE LIMIT RAISE	OFF D1	Offline
5	00005	#1 GATE LIMIT LOWER	OFF D1	Offline
6	00006	GEN 1 EXCITATION	ON D1	Offline
7	00007	GEN 1 VOLTAGE RAISE	OFF D1	Offline
8	00008	GEN 1 VOLTAGE LOWER	OFF D1	Offline
9	00009	GEN 1 CLOSE CONTACTOR	OFF D1	Offline
10	00010	GEN 1 SYNC TIME OUT	OFF D1	Offline
11	00011	GEN 1 AUTO INTERLOCK	OFF D1	Offline
12	00012	GEN 1 SPARE RELAY	OFF D1	Offline
13	00013	GEN 1 SPARE RELAY	OFF D1	Offline
14	00014	GEN 1 SPARE OUTPUT	OFF D1	Offline
15	00015	GEN 1 SPARE OUTPUT	OFF D1	Offline
16	00016	GEN 1 SPARE OUTPUT	OFF D1	Offline
17	00017	GEN 2 START TURBINE	OFF D1	Offline
18	00018	GEN 2 STOP TURBINE	OFF D1	Offline
19	00019	GEN 2 APPLY BRAKES	OFF D1	Offline
20	00020	#2 GATE LIMIT RAISE	OFF D1	Offline

To view or manipulate data in the Data Window:

1. Type an address or tag in the address field. Press [Enter] to accept the address/tag.

NOTE: Press [Ctrl L] on the Description or Tag column to display the **Documentation Editor**.

2. The status of the register address can be turned on or off by selecting **Status on/off** from the shortcut menu. To modify discrete (0x and 1x) data values, click the right mouse button in the data field and select **On** or **Off** from the menu. To modify register data (3x and 4x) enter data values directly into the register's data column.
3. Repeat steps 2 and 3 for each value you want to view. After entering a value, select the **Data / Next Address** menu item or press [F5] to move down one cell and fill in the next address or tag, or select the **Data / Previous Address** menu item or press [F6] to move down one cell and fill in the previous address or tag.

4. Select the **Edit / Clear** menu item to clear a row or rows. Select the **Edit / Delete** menu item to delete a row or rows; subsequent rows will move up.
5. You can disable or enable a reference that is used in your ladder program. A reference is considered disabled when the program logic is by-passed and you control the I/O state. To disable a discrete, click the **Disable Off** and **Disable On** buttons. To enable a discrete, use the **Enable** button. Only 0x and 1x discrettes can be disabled and enabled. You can also use the pop-up menus to disable and enable states.
6. You can create tables of addresses, store them to a file, and load them again offline or online. To save a list of addresses, select the **Data / Save Template** menu item. To load a list of addresses, select the **Data / Load Template** menu item.
7. Double-click the **Control Menu** box in the upper left corner of the active window to exit the **Data Window**.

Customizing the Display

The Data Window can be customized to display Tags, Description, both Tags and Description or neither. These columns can be displayed if selected in the **Program Setup**.

To modify the display, select the **Options / Program Setup** menu item or press [Alt-O, P]. Under the **Data Window** Tab, click the **Tag** selection box to include tags and/or click **Description** to include the description. De-select both if you do not want to include Tags and Description.

Data Format

Data Format is available for 3x and 4x addresses.

To change the data format:

1. Highlight a single or group of 3x and 4x registers.
2. Select the **Data / Format** menu item or select **Format** from the pop-up menu while in the Data Window. The **Data** menu is available only while in the Data Window. The **Format** menu appears.

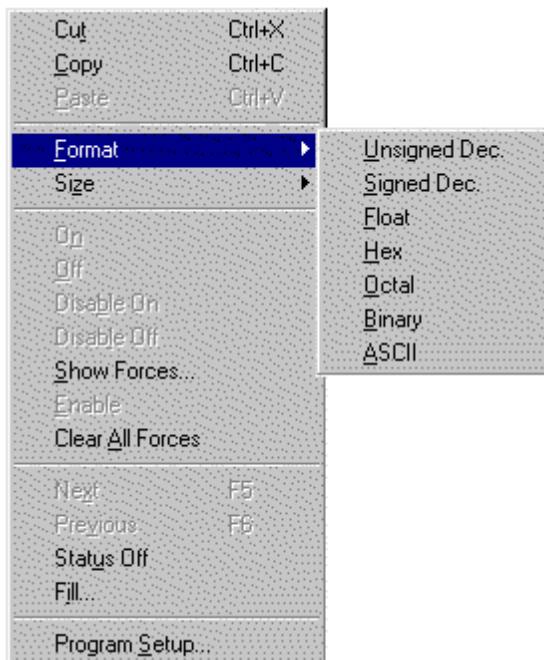

3. Select the desired data format and enter the number of characters to be displayed (1-64) in the **String** field.
4. Click **OK** to accept the format and return to the Data Window.

Editing Logic

PLC WORKSHOP uses a number of timesaving editing features to help you complete your programming tasks. These include:

- Cut
- Copy
- Paste
- Paste with Rewire
- Replace Table
- Insert
- Clear
- Delete

These editing features are accessed through the Edit menu and keyboard commands. Please see Chapter 3, PLC WORKSHOP Basics, for a more complete description of the editing features.

Cut, **Copy**, and **Paste** are probably the most frequently used editing features. The list below describes Cut, Copy, and Paste differences.

Cut	Removes the selection from the program and places it on the clipboard.
Copy	Copies the selection and places it on the clipboard.
Paste	Inserts clipboard contents into the program at the cursor location.
Paste with Rewire	Inserts clipboard contents into the program at the cursor location and allows the user to re-address any addressable items contained in the clipboard.

Cut

To use the cut feature:

1. Select the information to be cut.
2. Select the **Edit / Cut** menu item, click the  toolbar icon, or press [Ctrl-X].

Copy

To use the copy feature:

1. Select the information to be copied.
2. Select the **Edit / Copy** menu item, click the  toolbar icon, or press [Ctrl-C].

Paste

To access the paste feature:

1. Move the cursor to the desired location.
2. Select the **Edit / Paste** menu item, click the  toolbar icon, or press [Ctrl-V].

NOTE: When pasting, clipboard contents are inserted before existing items. For example, if you are pasting a network and the cursor is positioned at Network 2, click paste and the clipboard contents become Network 2. The previous Network 2 becomes Network 3.

Paste with Rewire

To access the rewire feature:

1. Move the cursor to the desired location.
2. Paste clipboard contents into the new location.
3. Select the **Edit / Paste with Rewire** menu item. The **Paste with Rewire** dialog appears.

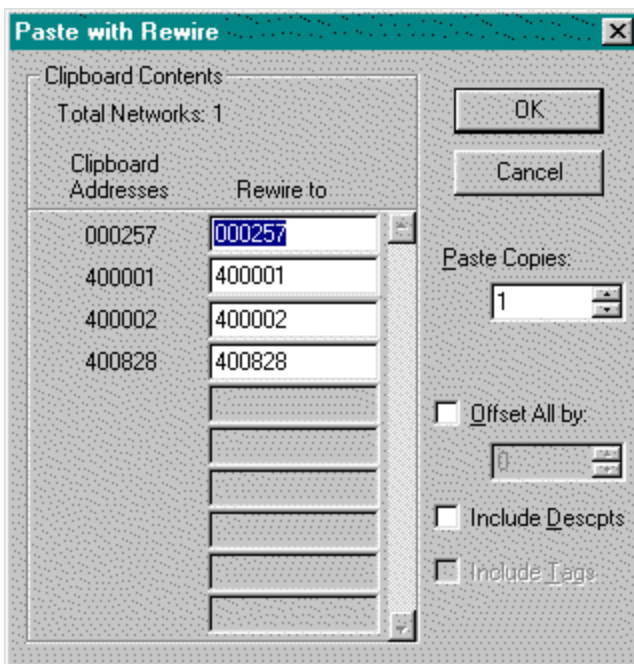

4. Choose the appropriate options and click **OK**.

Clear

Use the Clear dialog to clear an item without removing the space it occupies.

To clear an item or items:

1. Select the item or items to be cleared by clicking, holding and dragging the pointer over the desired logic.
2. Select the **Edit / Clear** menu item or press the [Delete] key.
3. Click the items you want to clear.
4. Click **OK** or press [Enter] and the selected items are cleared.

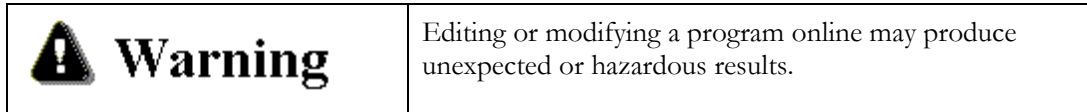
**Delete**

Use the Delete dialog to clear an item and remove the space it occupies.

To delete:

1. Select the item or items to be deleted.
2. Select the **Edit / Delete** menu item.
3. Click the items you want to delete.
4. Click **OK** or press [Enter].

Insert

Use the Insert dialog to insert a selected object (network, row or column) at the point of the current cursor position.

To insert an object:

1. Select the **Edit / Insert** menu item.
2. Click on the object to be inserted.
3. Click **OK** or press [Enter].

Pop-up Menus

Menu items for editing logic are also available by clicking the right mouse within the logic window.

PLC WorkShop for Modicon – 32 incorporates use of various function key alternatives and CTRL/ALT functions.

Windows Default Hot Keys

The following Windows Default hot keys can be automatically used:

Windows Default Hot Key	Function
Ctrl A	Select All
Ctrl C	Copy

Ctrl D	DX Zoom Screen
Ctrl F	Find
Ctrl L	Edit Documentation Window
Ctrl N	New Program
Ctrl O	Open Program dialog box
Ctrl P	Print
Ctrl S	Save Program
Ctrl T	Transfer Offline to Online.
Ctrl U	Address Used
Ctrl V	Paste
Ctrl X	Cut
Ctrl Z	Undo Changes
F1	Help
F3	Insert Network
F8	Validate and Enter
F9	Branch Down
F10	Activate Menu
DEL	Clear current element
END	Moves to last column/row 1 of current rung
ENTER	Edit: moves to next row, current rung, or to next rung Display: moves to next row or rung
ESC	Deletes current address and put you into edit mode for address
Shift F2	Trace Coil
Shift F3	Untrace Coil
TAB	Deletes current address and put you into edit mode for address
? or \	List mnemonics for current field
HOME	Moves to column 1, row 1 of current rung
-	Draws horizontal line
PgUp	Page Up
PgDn	Page Down
Ctrl L	Edits synonym/descriptor

WorkShop DOS Hot Keys

The following WorkShop DOS hot keys can be used. To enable use:

6. Select the **Options / Program Setup** menu item.
7. Select the **Logic** tab.
8. Select Options for General.

9. Within the Hot key options field, select FasTrak/GraySoft DOS.
10. Click **OK**.

WorkShop DOS Hot Key	Function
Alt P	Print
Alt D	Data Screen
Alt V	Data Screen
Alt W	Modify Documentation
Alt H	Edit Headers
Alt L	Toggle Labels off and on
Alt R	Address Used
Alt Z	DX Zoom Screen
F1	Normally Open Contact
F2	Normally Closed Contact
F3	Coil
F4	Help
F5	Insert
F8	Horizontal Short
F9	Vertical Branch
F10	Validate and Enter

Modsoft Hot Keys

The following Modsoft hot keys can be used. To enable use:

11. Select the Options / Program Setup menu item.
12. Select the **Logic** tab.
13. Select **Options for General**.
14. Within the **Hot key options** field, select **Modsoft**.
15. Click **OK**.

Modsoft Hot Key	Function
/	Normally Closed Contact
" or ´	Normally Open Contact
or F9	Vertical Branch
=	Horizontal Short
[or (Coil
F2	Edit mode for address
F3	Insert Row

Validate and Enter Logic

While programming in Offline mode, logic must be validated and entered before it can be saved to disk or transferred online. See *Online versus Offline Programming* earlier in this chapter to see the differences of how logic is validated and entered in online and offline.

To validate and check your logic, select the **Program / Validate and Enter** menu item, click the  toolbar button, or press [F8]. The message, Validating Logic appears on the screen. Problems are reported and must be fixed before the logic can be saved or transferred online. After logic is validated and entered and, if necessary, problems fixed, the logic program can be saved or transferred online.

Disabling/Enabling Discrete I/O

A reference is enabled when a ladder program controls it. A reference is disabled when the program logic is by-passed and you control the I/O state. Use the **Data** screen to disable discrete I/O references on or off and to enable previously disabled discrete I/O.

Disabling Data

Disabling is useful for simulating the presence of I/O devices that have not yet been installed, or for bypassing a defective I/O device until it can be replaced.

CAUTION: Only qualified persons familiar with the operation of the PLC program and the effects that disabling may have on it should use the disabling function. Some logic functions can change the state of a disabled coil. All DX function blocks override the disabled status of a coil in the destination node. This may cause personal injury if a coil, assumed to have been disabled, changes state while a repair is being made.

To Disable an I/O Reference On

When an I/O reference is disabled on, the bit is set to 1 and remains set even though the input status or program network controlling that bit would normally cause it to be reset. The I/O must be enabled before the bit can be reset.

To Disable an I/O Reference Off

When an I/O reference is disabled OFF, the bit is reset to 0. The bit remains reset until enabled and set.

To Remove the Disabling

Disabling is removed by enabling the specified reference.

To Disable a 0XXXX or 1XXXX Reference

From the **Data Window**:

1. Click on the right mouse button while in the **Data** field of a 0XXXX or 1XXXX Reference number.
2. From the menu select the type of forcing action you would like to do. Use **DISABL ON** or **DISABL OFF** to disable the state of the I/O.

From the Ladder Editor:

1. From the **Ladder Editor** select the element to force.

2. While on the element select the **Diagnostics** menu. From the menu select the type of forcing action you would like to do. Use **DISABL ON** or **DISABL OFF** to disable the state of the I/O.

Enabling Data

When a bit is enabled, it is once again controlled by the logic of the ladder program.

To Enable a Reference that has been Disabled

To enable a reference that has been disabled:

From the **Data Window**:

1. Click on the right mouse button while in the **Data** field of a reference number to enable.
2. From the menu select **Enable**.

From the Ladder Editor:

1. From the **Ladder Editor** select the element to enable.
2. While on the element select the **Diagnostics** menu or click on the right mouse button. From the menu select **Enable**.

To Enable All I/O References that have been Disabled

To enable all I/O references that have been disabled:

From the **Data Window**:

1. Click on the right mouse button while in the **Data** field.
2. From the menu select **Clear All Forces**.

From the Ladder Editor:

1. From the **Ladder Editor** select the **Diagnostics** menu.
2. From the menu select **Clear All Forces**.

Show All Forces

To show all disabled I/O:

From the **Data Window**:

1. Click on the right mouse button or select the **Diagnostics** menu while in the **Data** field.
2. From the menu select **Show All Forces**.

DX Zoom

DX blocks are function blocks for communications, extended mathematics, and other specialty functions. Use the DX Zoom function within a program to display information about DX blocks on a Zoom screen.

The amount of information displayed varies with the function you select. Some functions, such as the Search instruction, display information based upon how you configured the instruction. (See *Variable Length Functions*.) Some functions, such as the PID2 instruction, display a consistent amount of information, regardless of how you configure the instruction.

The **Text Search** feature allows for a search of both addresses and key words within the **DX Zoom** window. For address searches, the complete address must be typed in, followed by clicking the **Find** button. Should the address be found, it will be highlighted with an outline box.

Subsequent searches for the same address can be repeated by again clicking on **Find**. Searching for key words is neither case-sensitive nor supports the use of wildcards (ie. *). A successful search will be performed within the address/parameter descriptions and will highlight the corresponding address. A search may be repeated by clicking **Find** for every occurrence.

To access a **DX Zoom** screen, press [Ctrl - D] when the cursor is on a zoomable function.

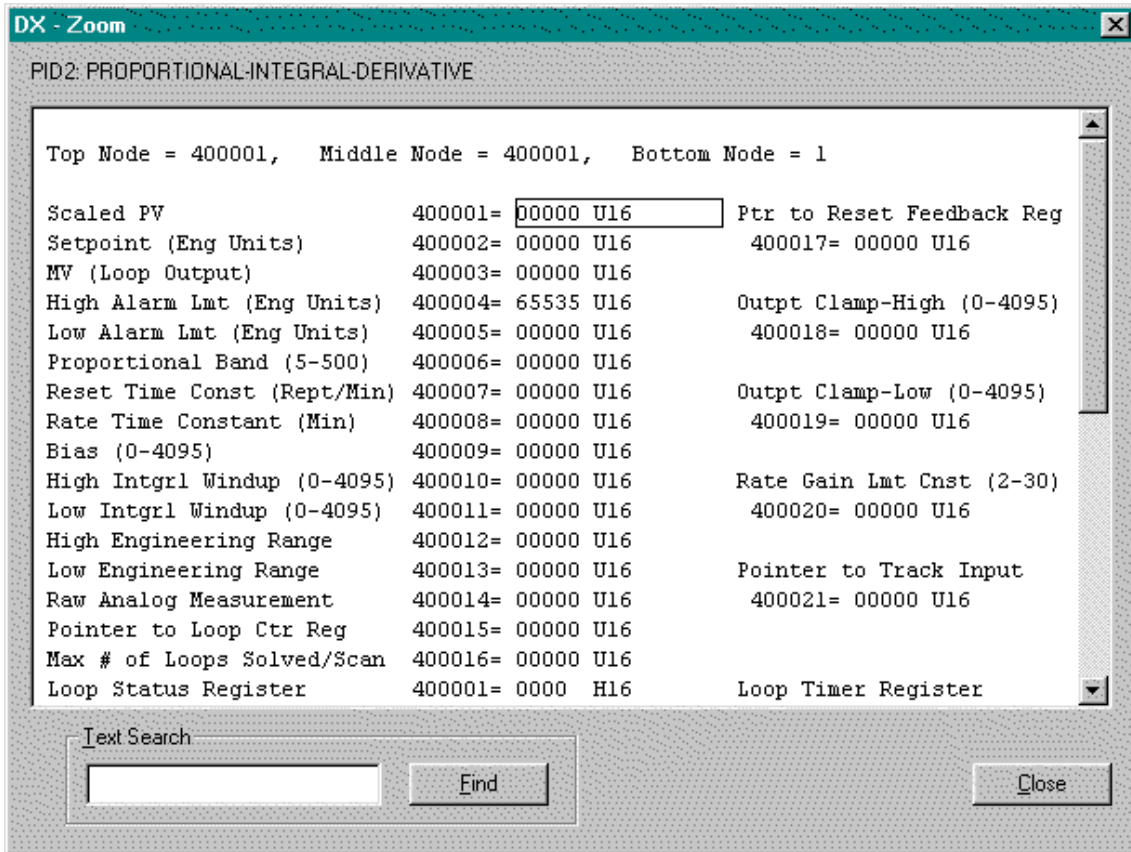

Using the Zoom Screen

The Zoom screen, like the Data Screen, displays data values you can change. The references can be of two types:

Discrete data values: Displayed standard 0XXXX and 1XXXX formats.

Register data values: Displayed in standard 3XXXX and 4XXXX formats and as bit ranges.

If the PLC type is a 785L with extended memory or a 984B with extended memory, the addressing size will change to six digits.

For example, 611234:

6 = file type

1 = file number

1234 = element number

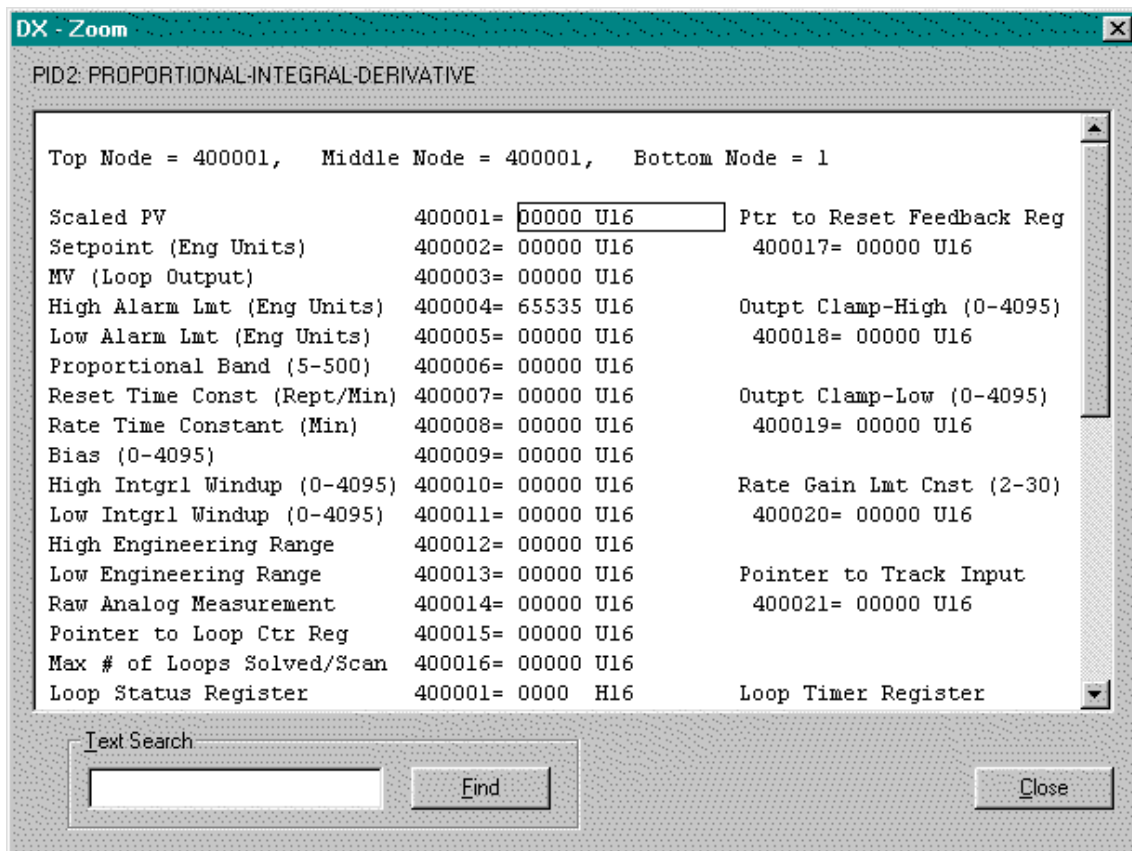

Cursor Movement

The cursor marks the position where you can enter addresses and data values.

To move the cursor to any address position in any column, use the arrow keys on the numeric keypad.

Zoomable DX Functions

Zoomable Instructions

The following instructions are zoomable. The zoom screens for the SRCH and PID2 instructions are illustrated and described later in this chapter.

AND

BLKM

BLKT

BROT

CKSM

CMPR

COMP

EMTH1 - EMTH38

FIN

FOUT

MBIT

MSTR

OR

PCFL

PID2

R->T

READ

SENS

SRCH

STAT

T->R

T->T

TBLK

WRITE

XMRD

XMWT

XOR

Zoomable Loadable Modules

CALL

DISA

DRUM

EARS

EUCA

FN10 - DELTA SYSTEMS (SUBFNT 1,5-33)

HIST

HLTH

HSBY

ICMP

MAP3

MBUS

PEER

Variable-Length Zoom Functions

If you select a variable length function, the amount of information displayed in the zoom depends upon how you configure the instruction. A Search instruction, illustrated below, is a sample of a variable-length instruction. The configuration of the SRCH instruction will result in the following zoom screens.

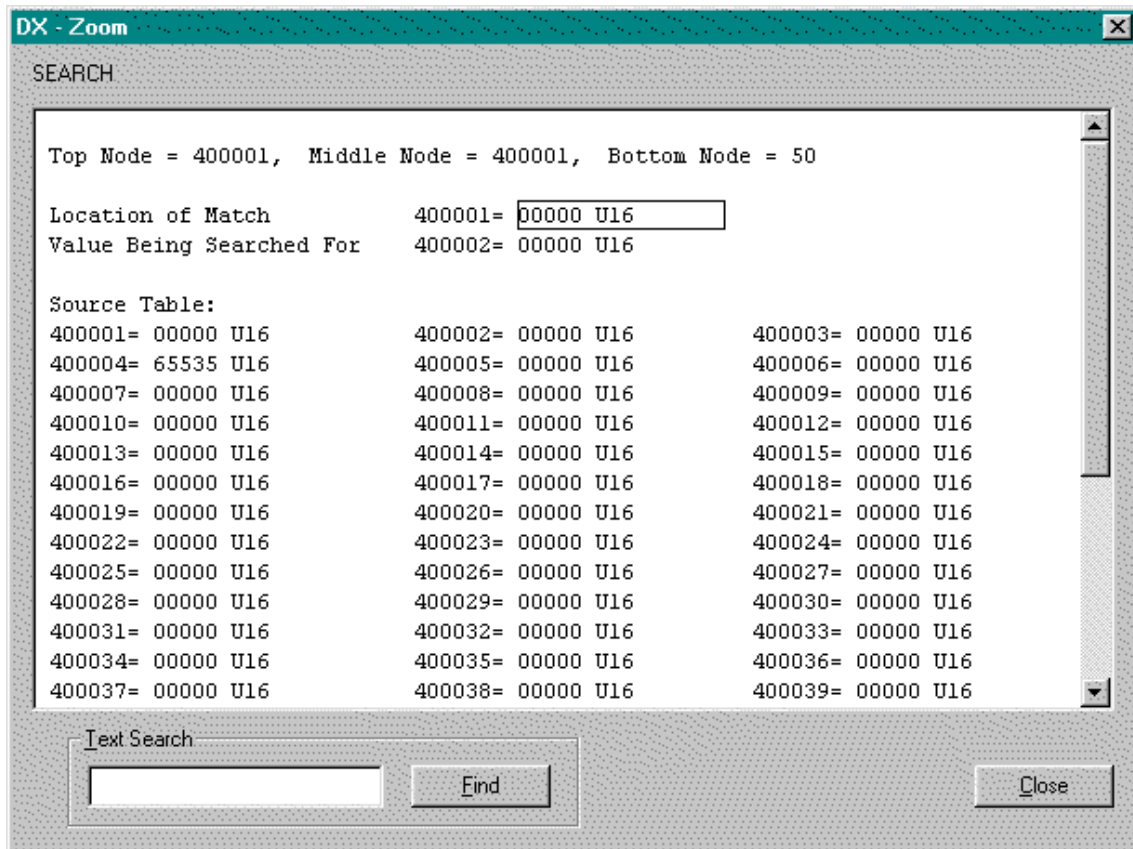

Zoom Function for PCFL Instruction (EQN Function)

The EQN function of the PCFL instruction is an example of a Zoom screen for an instruction that makes use of bit ranges and entry of a formula string on the status line.

The instruction in Figure 16.15 will result in the zoom screens illustrated in Figure 16.16.

Entering a Formula String

To edit or create the formula displayed in the **Equation** dialog box, click the **Enter Equation** button within the **PCFL - EQN Zoom** screen dialog box.

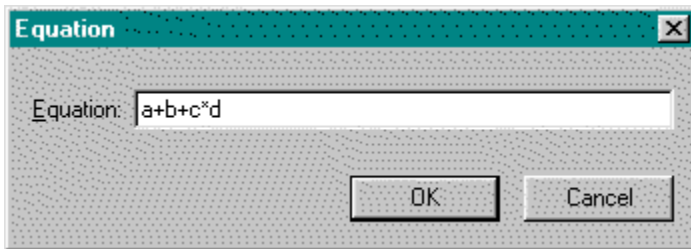

1. After pressing **Enter Equation** button, the cursor is placed at the end of an existing formula or after 'E = ' for a new formula.
2. Enter the string using variables (A, B, C, D) and **Operator Codes** (seen on page 2 of the **Zoom** screen).
3. When you have completed your formula, click **OK**. The correct codes are entered into the associated registers.
4. The total number of registers used in your formula (plus overhead) is displayed on page 1 of the **Zoom** screen. To optimize register usage, you may enter this number in the bottom node of the associated instruction.

NOTE: If the bottom node is less than the number displayed in the **Zoom** screen, then the number of registers displayed for the **Formula Code** and the **Registers Used Table** will be incorrect.

To Select the Data Format

Data stored in holding registers (4XXXX) and input registers (3XXXX) of the processor can be displayed in several numbering systems or formats. The default format is unsigned decimal. The available data formats are listed below. The codes (S, U, H, O, A) identify the current format of each reference and appear on the screen immediately after the reference value.

S	Signed Decimal
U	Unsigned Decimal
H	Hexadecimal
O	Octal
A	ASCII
Binary	Nothing is displayed
Float	Nothing is displayed
L	Long

To Change the Data Format of One Reference

1. On the **Zoom** screen use the cursor or mouse to highlight the reference whose data format you want to change.
2. Click the right mouse and select the new format or type in the number followed by the reference type code and press [Enter].

Using the Cross Reference Feature

In both online and offline programming, addresses or tags in a program can be tracked by viewing the Cross Reference table.

To access the Cross Reference table:

1. Select the **View / Cross Reference** menu item, or click the  toolbar icon. The **Cross Reference** window appears.

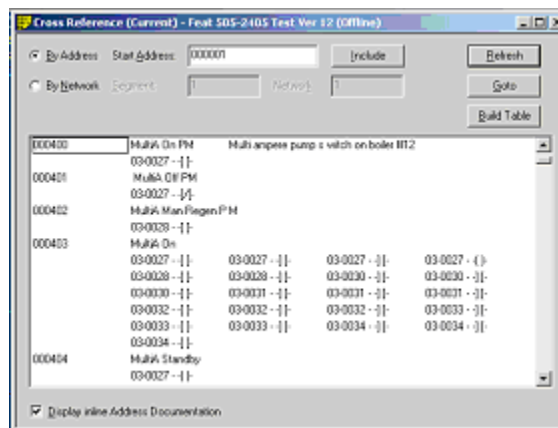

If more than one program has been loaded, the information displayed is for the program in the active window. The cross reference can be based on address or networks by checking the desired radio button on the cross-reference dialog box.

NOTE: Only validated and entered logic is considered part of the current program. Thus, logic not entered and validated will not show in the Cross Reference table. See *Validate and Enter Logic*.

2. Type in the starting address in the corresponding address box or network number in the corresponding network box if selected. Click the **Build Table** button. The cross reference will build and display the selected information in the list box. The address is displayed on the left side with the segment number and network number next to the element. To include the address tag and description next to the address within the list box, select the **Display inline Address Documentation** check box.
3. Select the logic item to view from the view window. Click the **Goto** button or double-click on the item to jump to the first occurrence of the address.

If the cross reference table status is not current, the title line gives the current status of the cross reference. Click the **Build Table** button to update the table.

NOTE: If the **Table Update** check box is selected in the **Program Setup** dialog, all changes made to segments that are validated and entered are automatically updated in the **Cross Reference** window.

Compare

File Program Compare

The File Program Compare feature compares two PLC programs, one of which may be online.

Any or all of the following program elements may be compared:

PLC Type	Segment Scheduler
Ladder	Loadables
Traffic Cop	Up to 7 ranges of memory:
ASCII Messages	Coils Used
ASCII Ports	0x, 1x, 3x, and 4x Address
Configuration	Disabled 0x and 1x Address
Configuration Extensions	

NOTE: The PLC type comparison is mandatory, and if the PLC types are not identical, the comparison is terminated.

To compare PLC program files:

1. PLC WorkShop compares the current file with a selected *.FMD file. Open the first file, either online or offline. This file is considered to be the “after” file. That is, a network that is in this file but not in the other is considered inserted.
2. Bring up the **File/Program Compare** dialog by selecting the **File/File Program Compare** menu option.

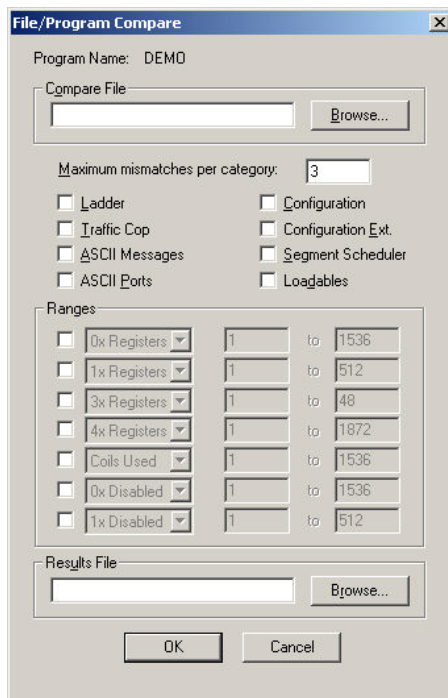

3. Click the **Browse** button to select the PLC program file to be compared against the current program. This file is considered the “before” file.

4. Set the **Maximum mismatches per category**. If PLC WorkShop finds that number of mismatches in any category, it stops the comparison for that category and moves on to the next category. If you are checking to see if the programs are identical or nearly so, set the value low. For a more comprehensive comparison, set the value high.
5. Select the categories to compare, by checking the appropriate boxes. For the memory ranges, select the category from the drop-down list, and enter the start and end addresses to be compared in the fields to the left.
By default, each of the range rows has a different category selected, but each row can be set to any memory category.
6. To save the results to a text file, click the **Browse** button and specify the file. If no file is specified, the results are displayed but not saved.
7. Click **OK** to start the comparison.

Compare Results

The results of the comparison are displayed in a dialog, and, if you specified a results file, in a text file.

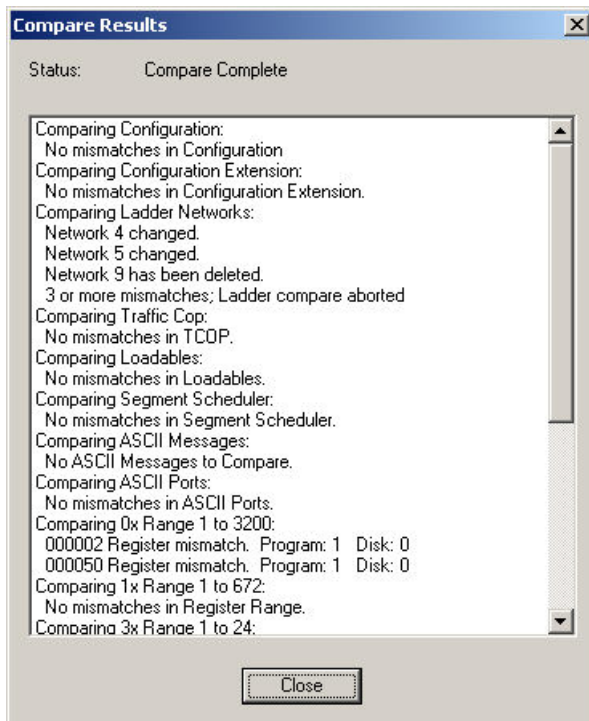

First, the PLC types are compared. If they do not match, that fact is reported and the entire comparison process ends.

Next, for each compared category, the information in the “before” program is compared to the corresponding information in the “after” program. As differences are found, they are recorded in the results:

If the number of mismatches is equal to the limit, that fact is reported, the comparison of that category ends, and the comparison continues on the next category.

If there are no mismatches in a category, that fact is recorded in the results.

Comparing Ladder Logic

Ladder logic is compared network by network. The results for each network are:

Matched - All instructions and parameters match and are in the same position. When networks match, nothing is recorded in the results.

Moved - A network in the “after” program matches a network in the “before” program, but the matching networks are not in the same position in their respective programs.

Changed - Half or more of the output coils match, but some instructions or parameters don’t.

Inserted - More than half the output coils in a network in the “after” program are different from any network in the “before” program.

Deleted - More than half the output coils in a network in the “before” program are different from any network in the “after” program.

Using the Diagnostic Features

Displaying Processor Status

You can display the status of your processor while online or offline.

To display the processor status:

Click **PLC Status** from the **PLC Utilities** menu [Alt+U, S]. Either the PLC Status for online or offline is displayed.

Click **Close** to close the **PLC Status** box and return to the active logic program.



PLC Status online

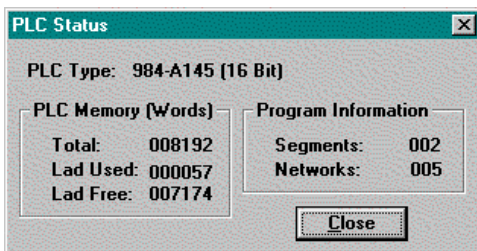

PLC Status offline

PLC Operations

This menu item allows you to view and modify PLC operations while online.

To access PLC Operations:

1. Click **PLC Operations** from the **Diagnostics** menu [Alt+D, P]. The **PLC Operations** dialog box appears.
2. On the left side you will see **Processor Status**, **Login Status**, and **Memory Protection**. The right side contains several option buttons, which are described below.

Start	Push Start and a warning message is displayed asking if you want to place the processor in run mode. Click Yes to place the processor in run mode. If the processor is in run mode, Start is disabled.
Stop	Press Stop and a warning message appears asking if you want to place the processor in stop mode. Click Yes to place the processor in stop mode. If the processor is stopped, Stop is disabled.
Debug	Press Debug and a warning message appears asking if you want to place the processor in debug mode. Click Yes to place the processor in debug mode. If the processor is in debug mode, Debug is disabled.
Optimize	Press Optimize and a warning message appears asking if you want to place the processor in optimize mode. Click Yes to place the processor in optimize mode. If the processor is in optimize mode, Optimize is disabled.

Login

Press Login and a warning message appears asking if you want to login to the processor. Click Yes to login to the processor. If PLC WORKSHOP is logged into the processor, Login is disabled.

Logout

Press Logout and a warning message appears asking if you want to logout from the processor. Click Yes to logout from the processor. If PLC WORKSHOP is not logged into the processor, Logout is grayed. If you are not logged on to the processor an automatic log on will be attempted by those functions requiring that PLC WORKSHOP be logged onto the processor.

3. Click **Close** to close the **PLC Operations** box and return to the active logic program.

Debugging Logic Programs (online)

Another diagnostic feature you will find helpful is Debug, which gives you the ability to control the scan of program logic. Debug is an online feature only.

To debug your logic:

1. Click **Debug** from the **Diagnostics** menu [Alt+D, D]. The **Debug** dialog box appears.

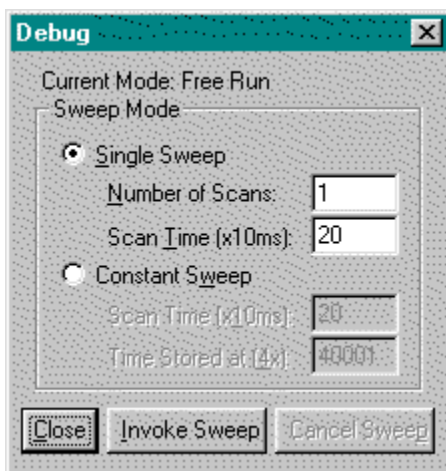

NOTE: The Debug box remains visible until you click **Close**. However, you are able to continue programming with the Debug box open.

2. Select either **Single Sweep** or **Constant Sweep** by clicking the option circle or pressing the Space Bar when the option is highlighted.
3. Enter the desired options for the sweep mode that you select. If you select Single Sweep, you cannot enter options for Constant Sweep and vice versa.
4. Click **Invoke Sweep** to begin the logic scan. Click **Cancel** to stop the scan.
5. When finished debugging the ladder logic, click **Close** to close the **Debug** dialog box and return to the active logic program.

Powerflow and Ladder Status (online)

You can display the values of your addresses and view the flow of power in the PLC by using Status and Powerflow. Status and Powerflow are available in online only.

Status and Powerflow will continue to update when you scroll and cursor within your online program.

To display ladder status:

1. Click **Logic Status** on the **Diagnostics** menu [Alt+D,L]. The **Logic Status** menu item displays a check if **Status** has been turned on.
2. Ladder status is indicated by the following features:

Normally Open contacts, coils and one-shots, when On, are displayed in Red. Normally-closed contacts are displayed in red when the status value is zero (Off).

Addresses in box instructions indicate the current value for each address.

If logic is skipped, the text “Skipped” is displayed to the right of the network header bitmap of each skipped network.

Disabled states are displayed with the text “DisOn” or “DisOff”, for disabled on and disabled off, respectively.

3. Click **Logic Status** on the **Program** menu to stop displaying status.

To display powerflow:

1. Click **Powerflow** on the **Diagnostics** menu [Alt+D, P]. The Powerflow menu item displays a check if powerflow has been turned on.
2. Powerflow is indicated by the following features:

The power rail at the left is displayed in Red. Starting from the left rail and moving left to right, instructions and connecting shorts and branches are displayed in red until the powerflow fails to continue.

Addresses in box instructions indicate the current value for each address.

If logic is skipped, the text “Skipped” is displayed to the right of the network header bitmap of each skipped network.

Disabled states are displayed with the text “DisOn” or “DisOff”, for disabled on and disabled off, respectively.

3. Click **Powerflow** on the **Diagnostics** menu to stop displaying powerflow.

Clearing Memory

This option allows you to clear all logic, including coils used and ASCII messages, data, tags, cross reference, and documentation in the current program. However values set in the PLC Configuration are not affected by using this option.

You can use clear memory in either online or offline mode. When programming offline, you clear the entire active program. When programming online, you clear the PLC memory. However you cannot clear memory online while the processor is in Run mode. You must first stop the processor before clearing the memory online. Also, you cannot clear memory if your PLC has a memory protection feature and it is turned on.

To access the Clear Memory option:

1. If you want to save the changes you've made to your logic and documentation, save them before going to Step 2. Use the **Save Program** or **Save Program As** options in the **File** menu.
2. Click **Clear Memory** from the **PLC Utilities** menu [Alt+U, C]. A warning message appears stating all program logic, data values, tags, and documentation will be deleted.
3. Click **Yes** to clear all memory. If changes to the program were not saved another warning message appears stating that changes to your program were not saved; do you wish to continue with the clear memory procedure. Click **Yes** to clear the memory.

8 - Documentation

Using the Segment and Network Headers Editor

Document networks with network header comments and entire segments with segment header comments. To open a header comment for editing, double-click the toolbar button. The applicable header dialog displays.

Segment Headers

1. Double-click the **Segment Header** icon in the active logic program window. The **Segment Header** dialog is displayed.

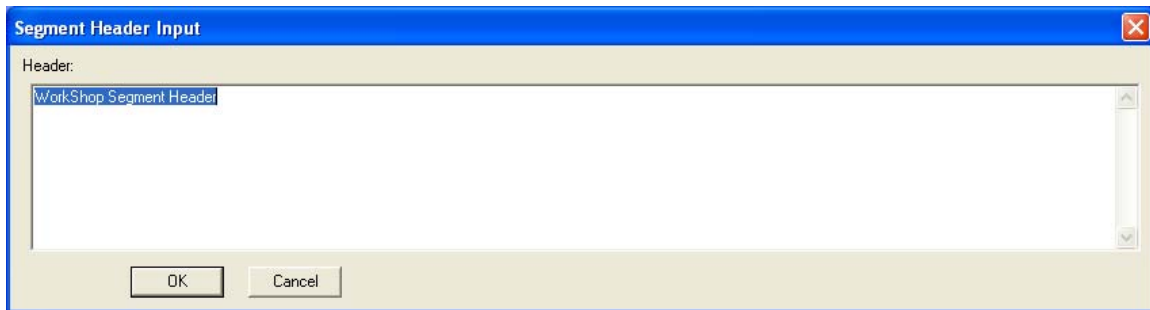

2. Type in your header. Click **OK** when you're finished.

To see segment headers in the active logic program:

1. Select the **Options / Program Setup** menu item.
2. Select **General** in the **Options for:** combo box.
3. Select the **Segment Headers** check box.

Network Headers

To create a network header:

1. Double-click the **Network Header** icon in the active logic program window. The **Network Header Input** dialog is displayed.

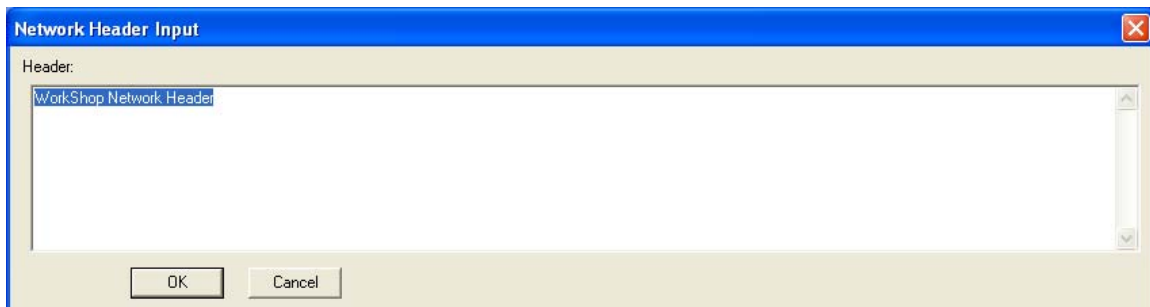

2. Type in your header and click **OK**.

To see network headers in the active logic program:

1. Select the **Options / Program Setup** menu item.
2. Select **General** in the **Options for:** combo box.
3. Select the **Show Network Headers** check box.

All Headers

The **All Headers** dialog lists all segment and network headers in the active program. Use the All Headers dialog to quickly manage and access segments and networks in the program.

To view all headers in the program:

1. Select the **View / All Headers** menu item. The **All Headers** dialog appears.

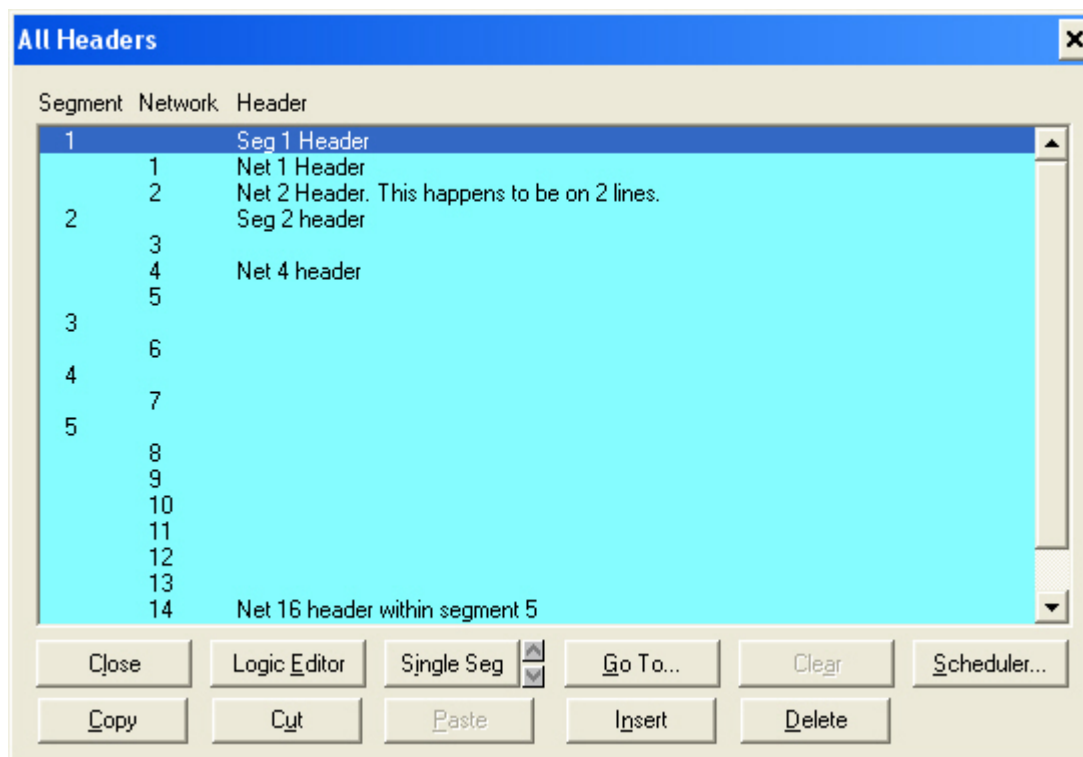

2. Select a segment or network by clicking the segment or network number.
3. Click the **Logic Editor** button to only view the segment headers within the program.
4. Click the **Single Seg** button to view the networks in the selected segment.
5. Click the **Go To...** button to display the selected segment or network in the **Ladder Editor**.
6. Click **Scheduler** to access the *Segment Scheduler* dialog.
7. Click **Close** to close the All Headers dialog and return to the active logic windows.

NOTE: The **Clear** button is enabled for the **Logic Editor** dialog only.

The **All Headers** dialog also allows you to edit all network and segment headers quickly and conveniently. To edit network and segment headers, highlight the header(s) you wish to edit and:

- Click the **Copy** button to copy the selected header information to the clipboard. This button is always enabled unless nothing is selected or two or more non-contiguous headers are selected.
- Click the **Cut** button to remove the selected header information and copy it to the clipboard. This button is always enabled unless nothing is selected or two or more non-contiguous headers are selected.

- Click the **Paste** button to paste the copied header information in the selected area, overwriting any existing header information in the area. This button is disabled when the clipboard is empty, nothing is selected, or more than one row is selected.
- Click the **Insert** button to paste the copied header information in the selected area, moving any existing header information in the area below the new information. This button is disabled when the clipboard is empty, nothing is selected, more than one row is selected, or if a segment header is selected. When a single network header is selected, the insert action moves all headers down by one row in the segment.

NOTE: If inserting headers will result in a header being dropped from the last network, a warning message will appear before the insert takes place.

- Click the **Delete** button to delete the selected header information.

NOTE: Header information cut or copied from the **All Headers** dialog may also be pasted into other applications, such as text editor or spreadsheets. The copied header information is retained on the clipboard as comma-separated values (CSV) and will be interpreted as such by applications that adhere to current CSV standards.

Using the Documentation Window

In both online and offline programming, you can view and edit tags, descriptions and comments in your program using the Documentation Window.

The **Documentation Window** allows you to view, create, edit and delete tags, descriptions and comments for the active logic program. The maximum number of characters for each item is defined below:

Descriptions 96

Tags 32

Comments 2048

To open the Documentation Window, select the **View / Documentation** menu item or click the  toolbar.

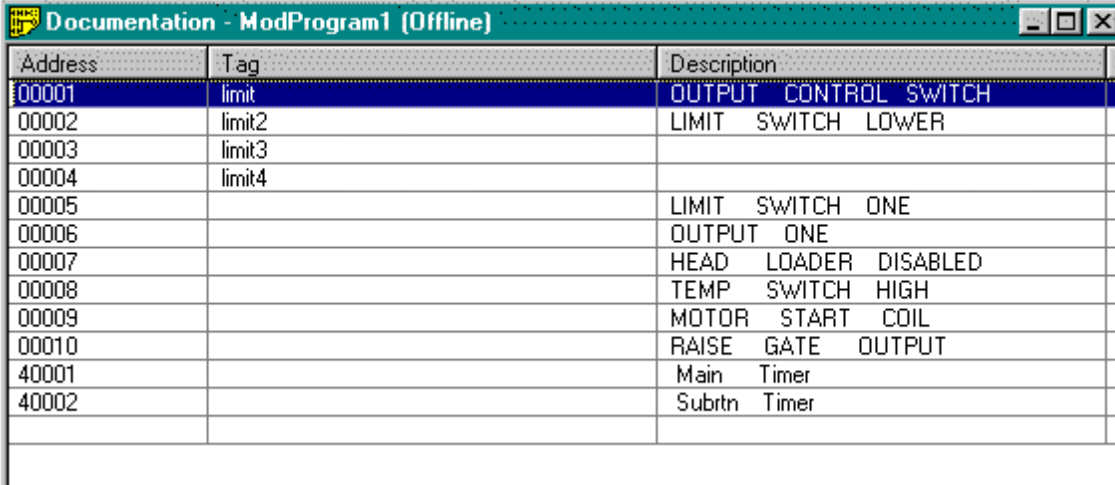

Address	Tag	Description
00001	limit	OUTPUT CONTROL SWITCH
00002	limit2	LIMIT SWITCH LOWER
00003	limit3	
00004	limit4	
00005		LIMIT SWITCH ONE
00006		OUTPUT ONE
00007		HEAD LOADER DISABLED
00008		TEMP SWITCH HIGH
00009		MOTOR START COIL
00010		RAISE GATE OUTPUT
40001		Main Timer
40002		Subrtn Timer

The window is displayed with all of the addresses, tags and descriptions in the current program. The first column indicates the method of sorting.

NOTE: Only 1 documentation window can be displayed per program.

The window also can be sized and moved to another location within the viewing area, using the standard window features.

Customizing the Display

The Documentation Window can be customized to display Tags or Descriptions, or both Tags and Descriptions. Setting options in the Program Setup can customize these. The Program Setup also allows the sorting method to be selected: by address, tags or descriptions.

To change the display:

1. Select the **Options / Program Setup** menu item. The **Program Setup** dialog appears.
2. Within the Program Setup dialog, click the **Documentation Window** tab.

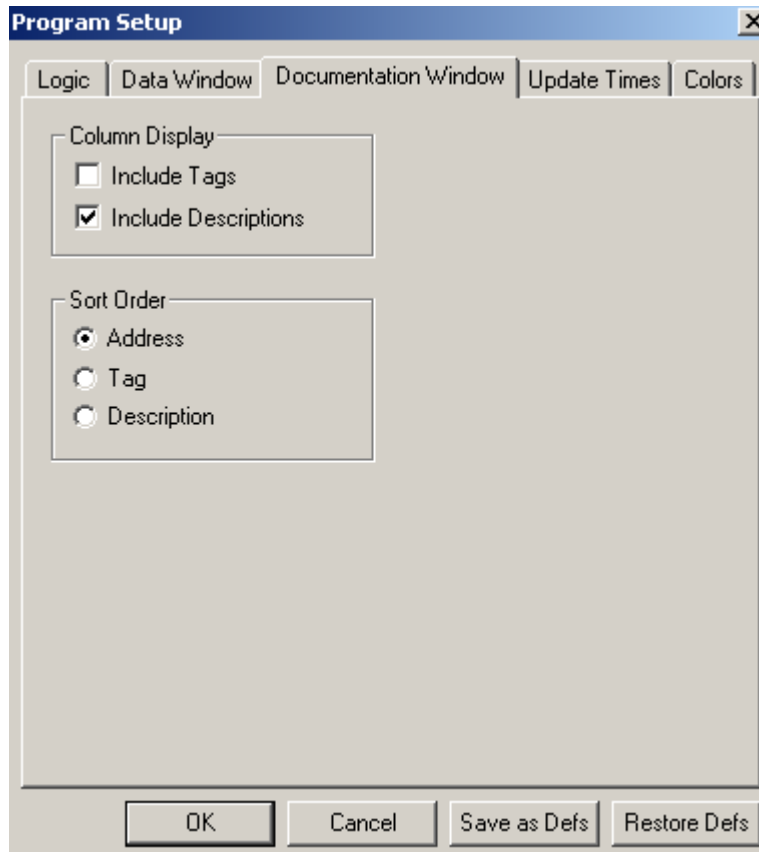

3. Within the Column Display group box:
 - Check the **Include Tags** check box to include tags.
 - Check the **Include Descriptions** check box to include address descriptions.

NOTE: Either Tags or Descriptions must be included.

4. Within the **Sort Order** group box select the radio button for **Address**, **Tag**, or **Description** to change the sort method. The sort order also modifies the Documentation Window by displaying the sort order method as the first column. For example, if the Sort Order is defined as Tag, then the first column in the Documentation Window is the Tag column. The address column is always included in the display. See *Program Setup* in Chapter 4 for more information.

Editing and Creating New Documentation

To create a new address tag, description and comment:

1. Select the **Documentation / New Doc** menu item, select **New Doc** from the right-click menu, press [Ctrl-L] on an open address field, or double-click within the open address field of the Documentation Window. The **Add New Documentation** dialog appears.

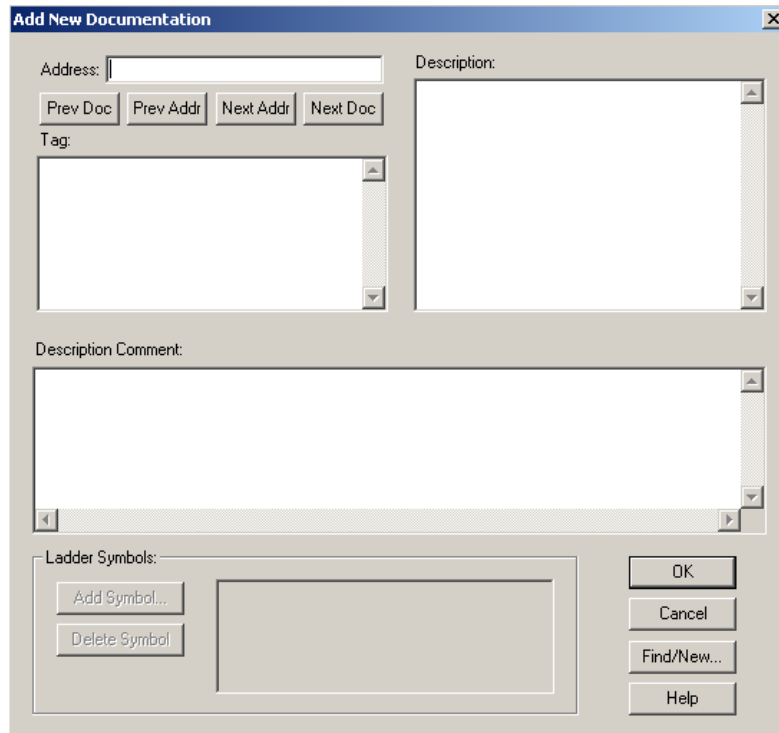

2. Enter the address to document in the **Address** edit box.
3. Enter a new tag, description, and comment.

The Tag and Description fields are sized according to the **Column Width** variable in the **Program Setup**. The font selected in program setup will also be used for the tag and description fields. This will show the documentation, as it actually will be displayed in the ladder program.

NOTE: If the font and size selected in the program setup are too large to be represented in the window, a standard font will be used. When this situation occurs, a warning message is displayed. The tag and description will NOT be shown in its actual size in this case.

To edit an existing tag or description:

1. Select the **Documentation / Modify Doc** menu item, select **Modify Doc** from the right-click menu, or press [Ctrl-L] on an address field within the Documentation Window. The **Edit Documentation** dialog appears.

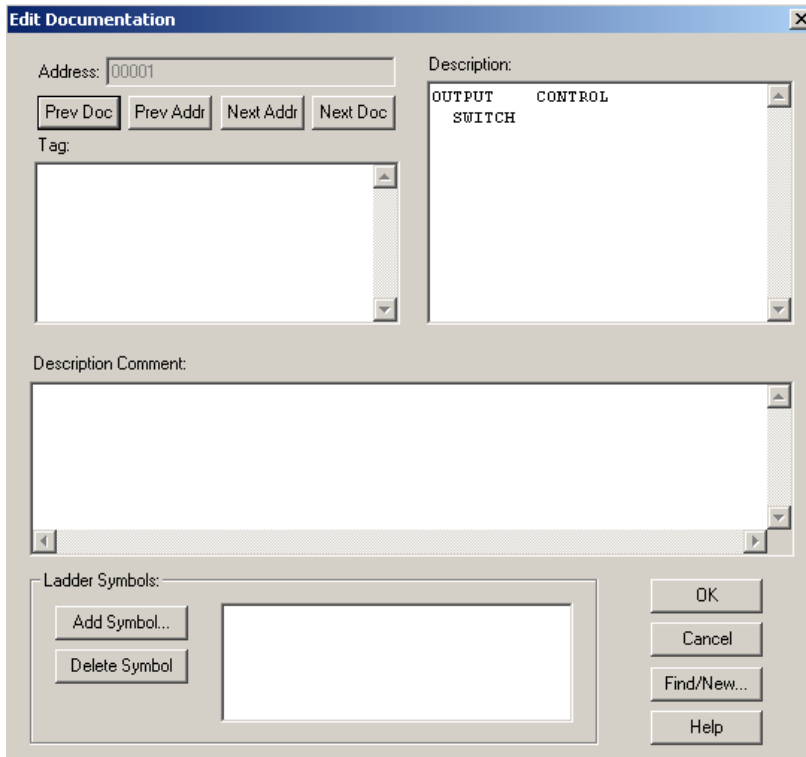

NOTE: You can also edit documentation in the **Data Window** by double-clicking in the description or tag columns.

2. Edit the tag, description, or comment.

Prev Doc: Click the **Prev Doc** button to display the previous address that has documentation associated with it.

Prev Addr: Click the **Prev Addr** button to display the previous address.

Next Addr: Click the **Next Addr** button to display the next address.

Next Doc: Click the **Next Doc** button to display the next address that has documentation associated with it.

Deleting Documentation

To delete an existing address tag, description and comment:

1. Within the Documentation Window, select the address/tag/description to be deleted.
2. Select the **Edit / Delete** menu item or select the **Delete** right-click menu item. The **Delete Range** dialog appears.

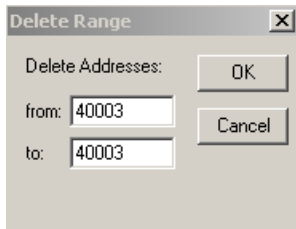

3. Confirm the addresses to be deleted and click **OK**.

Searching for an Address, Tag, Description or Keyword

Documentation associated with a specific address, tag, or description can be located by using the Find option. To find an item:

1. Select the **Edit / Find** menu item, click the  toolbar icon, press [Ctrl-F], press [Alt-E, F] or select **Find** from the right-click menu. The **Find** dialog appears.

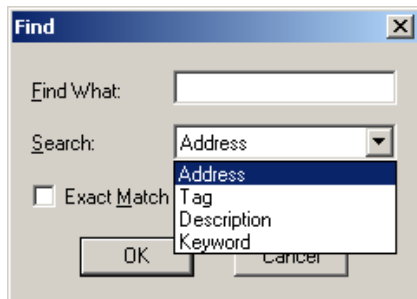

2. Enter the text to be searched for in the **Find What** field.
3. Select a search type of **Address**, **Tag**, **Description**, or **Keyword**. Find will try to locate the closest match to the entered search information.
4. Select the **Exact Match** check box if the text in the **Find What** field is the entire text to be found. If the search type is **Keyword**, the **Exact Match** check box will toggle to **Match Case**. Make this selection to perform a case sensitive search on the **Find What** text.

Addresses, tags, and descriptions that are found will be located, displayed, and highlighted in the Documentation Window. If a keyword is located, a similar message window appears with several search options.

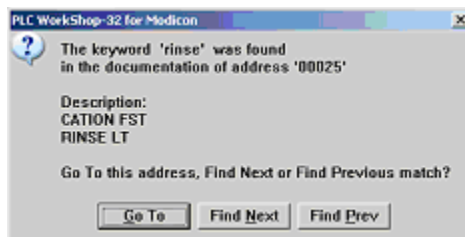

Go To - Click the **Go To** button to go to the address at which the keyword was found.

Find Next - Click the **Find Next** button to look for the next occurrence of the keyword.

Find Prev - Click the **Find Prev** button to reverse the search direction to look for previous occurrences of the keyword.

Documenting 4x BIT-of-WORD Addresses

4x addresses can be documented for information purposes. These BIT-of-WORD addresses are accessed through the Documentation Window. They cannot be used or referenced in any other part of WorkShop or the PLC.

To enter documentation for a 4x BIT-of-WORD address:

1. Access the **Add New Documentation** dialog.
2. Within the Add New Documentation dialog, enter the BIT-of-WORD address to document in the **Address** edit box. The entire address may be entered or standard address shorthand may be used. For example, to specify BIT 12 of address 400022, enter 4:11.12.
3. Enter the **Tag, Description, and Description Comment**.

The 4x BIT-of-WORD address documentation appears sorted by WORD and BIT in the Documentation Window as illustrated in the following example:

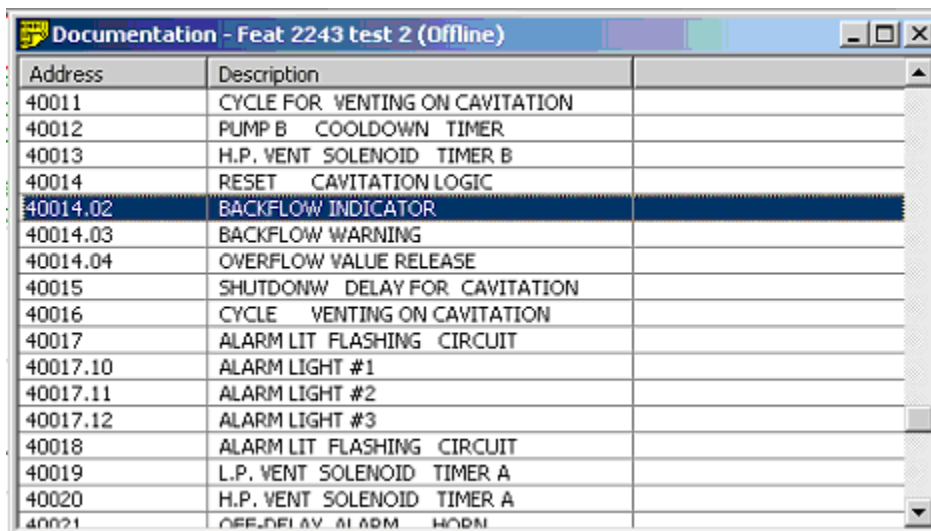

Address	Description
40011	CYCLE FOR VENTING ON CAVITATION
40012	PUMP B COOLDOWN TIMER
40013	H.P. VENT SOLENOID TIMER B
40014	RESET CAVITATION LOGIC
40014.02	BACKFLOW INDICATOR
40014.03	BACKFLOW WARNING
40014.04	OVERFLOW VALUE RELEASE
40015	SHUTDOWN DELAY FOR CAVITATION
40016	CYCLE VENTING ON CAVITATION
40017	ALARM LIT FLASHING CIRCUIT
40017.10	ALARM LIGHT #1
40017.11	ALARM LIGHT #2
40017.12	ALARM LIGHT #3
40018	ALARM LIT FLASHING CIRCUIT
40019	L.P. VENT SOLENOID TIMER A
40020	H.P. VENT SOLENOID TIMER A
40021	OFF DELAY ALARM HORN

Cutting, Copying, and Pasting 4x BIT-of-WORD Address Documentation

4x BIT-of-WORD address documentation can be cut, copied and pasted like other documentation.

However, documentation for BIT-of-WORD addresses can be cut, copied and pasted at WORD address boundaries only.

In the example above, the documentation for addresses **40014.03** and **40014.04** cannot be cut or copied alone. The documentation for all **40014** addresses must be cut, copied and pasted as a group. So copying documentation from addresses **40014** to **40016**, copies the documentation for the six addresses within this range: 40014, 40014.02, 40014.03, 40014.04, 40015 and 40016.

Viewing 4x BIT-of-WORD Address Documentation

When viewing the documentation of a 4x BIT-of-WORD address clicking the **Prev Doc** and **Next Doc** buttons displays the previous and next documented address regardless of whether that address is a 4x WORD or BIT-of-WORD address. However, clicking the **Prev Addr** and **Next Addr** buttons displays the previous and next 4x BIT-of-WORD addresses only. The WORD of the 4x address is not included in the next and previous address display.

In the example above, clicking **Prev Addr** once displays the previous BIT-of-WORD address **40014.03**. Clicking **Prev Addr** twice more displays the BIT-of-WORD address **40014.01**. Clicking **Prev Addr** once more displays the previous BIT-of-WORD address **40013.16**, not the WORD address **40014**.

Similarly, when viewing a 4x WORD address, clicking **Prev Addr** displays the previous WORD address. If the 4x WORD address **40014** was displayed above, clicking **Prev Addr** once displays the previous 4x WORD address **40013**. Clicking **Prev Addr** twice more displays the 4x WORD address **40011**.

NOTE: The **Import** function will also import Taylor and Modsoft 4x BIT-of-WORD addresses.

Documenting in Ladder

In addition to editing and creating new documentation in the Documentation Window, you can also edit and create new documentation in the logic program as you enter and edit your logic. The Documentation Window can also be used to help you program your logic.

In the logic editor, these features are available:

- Assign Tags
- Assign Addresses
- Edit and Create Documentation in Ladder
- Look up tags and use them in ladder

These items are discussed in the following sections.

Assign Tags

The Assign Tags option allows you to assign tags, descriptions and comments to an undocumented address that you are currently using in your ladder program. For example, if you enter an address in an ADD instruction, and that address does not have a tag or description, the Edit Documentation window in Figure 7.3 will automatically appear when you move off the address. Enter a tag, description and comment and click OK to save the documentation. This allows you to document undocumented addresses as you program without leaving the ladder editor.

To assign tags:

1. Select the **Options / Program Setup** menu item or press [Alt-U, P].
2. Select **Ladder** in the **Options for:** combo box.
3. Select the **Assign Tags** check box.

Assign Addresses

The Assign Addresses option allows you to assign addresses, descriptions and comments to tags as you use them in your ladder program. For example, if you enter the tag NEW_TAG (and NEW_TAG doesn't exist), the **Edit Documentation** window in Figure 7.3 will automatically appear with the tag filled in. You can enter the address, description, and comment and click **OK** to save the documentation. This allows you to assign addresses to tags as you program without leaving the ladder editor.

To assign addresses:

1. Select the **Options / Program Setup** menu item or press [Alt-U, P].
2. Select **Ladder** in the **Options for:** combo box.
3. Select the **Assign Addresses** check box.

Editing Documentation in Ladder Editor

You can automatically assign documentation and edit existing documentation by double-clicking on an address in your ladder program. For example, if you would like to change the documentation for the address 00001 that is used on a contact, move the cursor to that location and double-click with the mouse. The **Edit Documentation** window in Figure 7.3 automatically appears. Enter the tag, description and comment and click **OK** to save the documentation.

Edit Title Page (Print Only)

This option allows you to display descriptive information at the beginning of your printouts.

To access the Edit Title Page option, select the **View / Title Page Print Editor** menu item. The following dialog window is displayed.

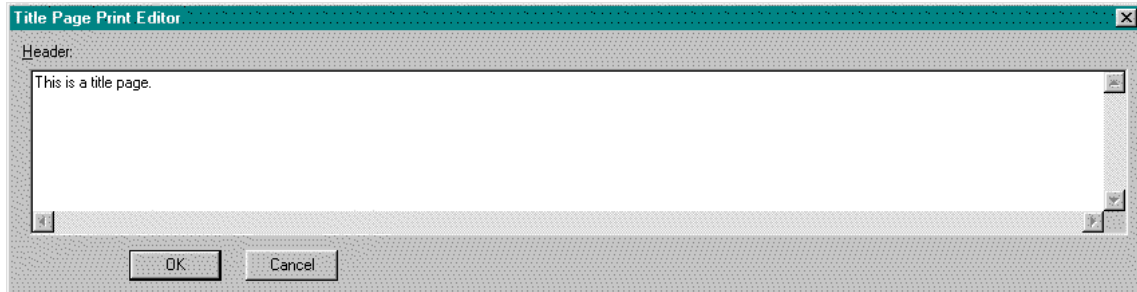

Enter the text to be displayed and click **OK**.

9 - Symbols

Overview

Symbols are a graphical representation of logic instructions such as Normally Open contacts, Normally Closed contacts, and coils. The symbols can be used to document instructions or for programming ladder logic.

As can be seen by the provided figure to the left, a Symbol is similar to an instruction as it can be documented as well as used for logic. And like instructions, symbols can display status and power flow. Additionally, users can copy, merge, paste, and search for Symbols. Symbols may be animated during an on-line running of the program's logic. Animated symbols may also be edited.

Symbols can be a standard, such as IEEE, IEG, etc or they may be a user-defined standard. Symbols used within a program are stored with that program.

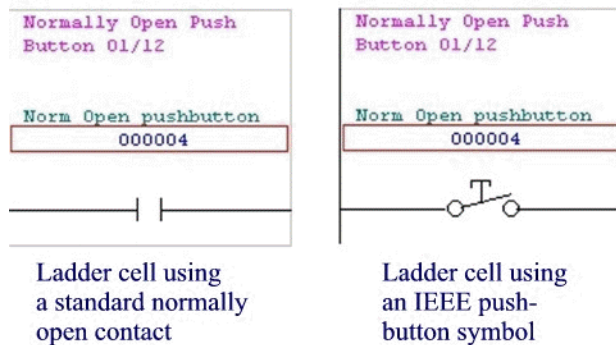

Using Symbols and Symbol Libraries in WorkShop

Prior to beginning a new ladder logic program, the location where WorkShop references the main symbols library may be viewed and changed. Select the **Options / Application Setup** menu item to view and edit this file's location.

Activating Symbol Toolbars

Once a new PLC program has been established, the ladder symbols must be activated to be displayed. By default, they are not active until the user activates them.

To activate the toolbars:

1. Select the **Options / Program Setup** menu item.
2. Click the **Logic** tab.
3. Select **Ladder** within the **Options for:** drop-down menu.
4. Select the **Show Ladder Symbols** check box within the **Individual Program Settings** group box.

Ladder Symbol Manager

The Ladder Symbol Manager allows the current library file to be changed or a new library to be created and edited. See *Accessing the Symbol Library*.

Using Toolbars

Once ladder symbols have been activated in the Program Setup dialog, the Symbol toolbar and pick window are available for use. The toolbar allows for the graphical selection of Normally Open and Normally Closed contacts and for Coils.

To view the Symbol toolbar, select the **View / Toolbars / Ladder Toolbars / Symbol Popup** menu item.

Symbols may be added or deleted from the Symbol Toolbars. See *Customizing the Symbol Toolbars*.

Customizing the Symbol Toolbars

Symbols may be added to or deleted from each of the symbols toolbars.

To customize these toolbars, select the **View / Toolbars / Ladder Toolbars / Customize Symbol Toolbars** menu item or click one of the following buttons: **Norm Open**, **Norm Closed**, or **Coils**. The **Customize Symbol Toolbars** dialog appears.

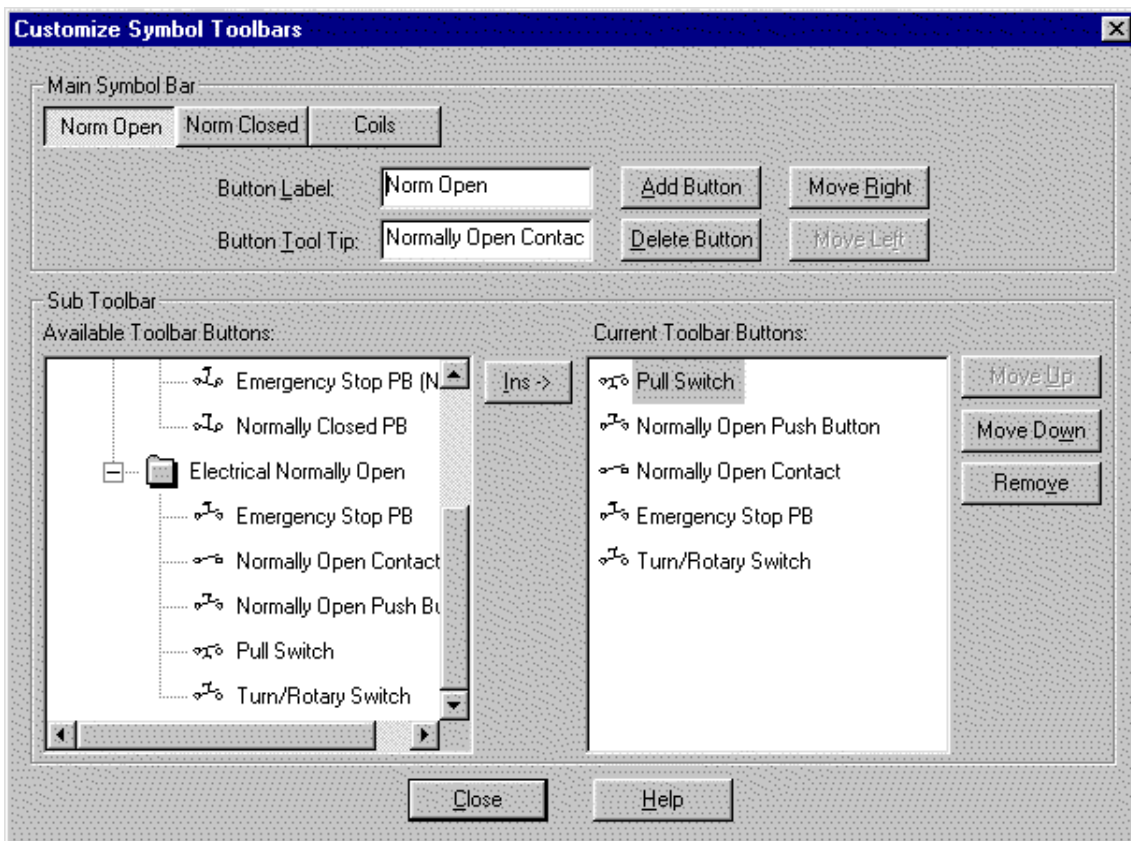

Click the **Norm Open**, **Norm Closed**, or **Coils** tab to edit an instruction toolbar. Cycle between the main symbol toolbar buttons by clicking on them or by clicking the **Move Left** or **Move Right** buttons. Additional customized toolbar buttons may be added and then edited or deleted by clicking the **Add** or **Delete** buttons. Additional buttons may be re-labeled by typing within the **Button Label** field. The **Button Tool Tip** may be edited in a similar fashion.

Symbols may be added to the **Current Toolbar Buttons** window by clicking on them from the **Available Toolbar Buttons** window and clicking the **Ins->** button. Their order may be moved by clicking to the right, on either the **Move Up** or **Move Down** buttons.

The **Sub Toolbar** group box is for customizing the sub tool bar represented by the depressed **Main Symbol Bar** button. It consists of a tree control displaying the current **Application Symbol Library** and a list box representing the buttons on the sub tool bar. Highlighting the Symbol in the Tree and pressing the **Ins->** button places that symbol on the current sub tool bar. Symbols on the sub tool bar can be removed or moved.

As an example, edit the **Norm Closed** button by opening the window using either of the two methods mentioned above. The window opens with the Norm Closed button grayed and depressed and the Button Label and Button Tool Tip field filled in. For the current application's available Symbols, the Normally Closed file is activated and open, ready for the user to choose Symbols. Choose a Symbol by clicking on it and then clicking the Ins button. The Symbol is now added to the Current Toolbar Buttons. If this step is omitted, the software will prompt with the Customize Toolbar Buttons dialog window, for the desired symbols to be added to the toolbars. This step is necessary for both contacts and coils.

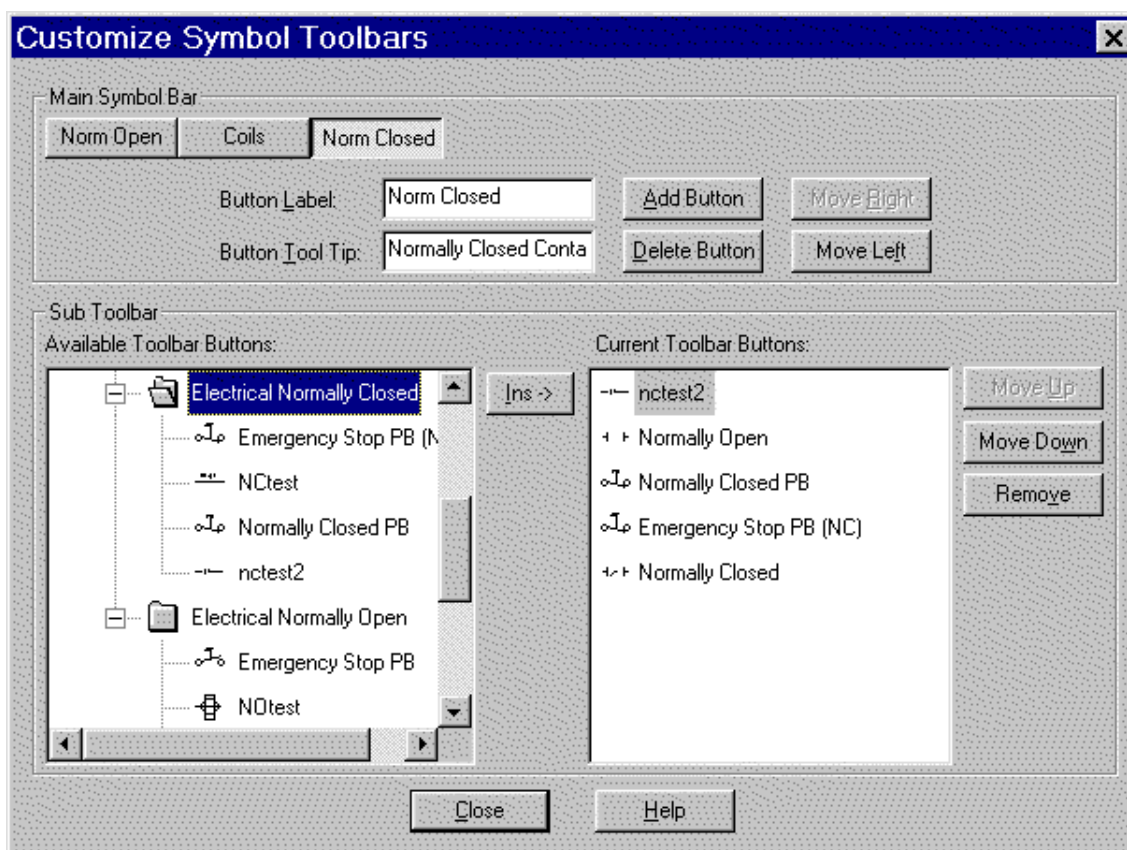

Programming with Symbols

Logic can be programmed with symbols by using the **Symbols Toolbar** and the **Symbol Pick** dialog window.

NOTE: Before programming can occur, the user must add desired symbols from the **Available Toolbar Buttons** section of the **Customize Symbol Toolbars** to the **Current Toolbar Buttons** section.

Programming with Symbols- Using the Toolbar

Similarly to using Logic Instructions Toolbars, the desired instruction's symbol is picked from the toolbar and the desired cell is clicked. To establish a relationship between a chosen symbol and an address used, the address must be entered prior to clicking off from the cell. This relationship can be used again while programming, by choosing the symbol and its address to be used elsewhere.

This relationship can only be removed within the **Edit Documentation** dialog. [CTRL-L] Before clicking off this cell, address the instruction with a valid address. If a symbol chosen no longer exists in the Symbol Application Library, the ladder type it represents will replace it within the logic.

A warning dialog may pop up when attempting to overwrite a current relationship with a different latter symbol. Clicking **Yes** will replace all occurring incidences within the logic program. Clicking **No**, cancels the operation.

A second warning dialog appears when entering a symbol with the same name but with different settings or symbol frames. Clicking **Yes** replaces the content with the current symbol from the Application Symbol Library. Clicking **No** keeps the original symbol. However, in either case, the symbol relationship is added to the logic program.

Programming with Symbols- Symbol Pick Dialog

Choosing and programming with Symbols can also be done through a menu item.

1. Begin by placing the cursor in the desired cell by clicking within it.
2. Select the **Program / Insert Ladder Symbol** menu item. The **Symbol Library Pick** dialog appears.
3. Choose the symbol either by double-clicking it or by clicking it once and then clicking **OK**.
4. To cancel the operation, either press [ESC] or click the **Cancel** button. A relationship between the address and symbol, mentioned earlier is created.

This relationship can only be removed within the **Edit Documentation** dialog [CTRL-L]. Before clicking off this cell, address the instruction with a valid address. If a symbol chosen no longer exists in the Symbol Application Library, the ladder type it represents will replace it within the logic.

A warning dialog may pop up when attempting to overwrite a current relationship with a different latter symbol. Clicking **Yes** will replace all occurring incidences within the logic program. Clicking **No**, cancels the operation.

A second warning dialog appears when entering a symbol with the same name but with different settings or symbol frames. Clicking **Yes** replaces the content with the current symbol from the Application Symbol Library. Clicking **No** keeps the original symbol. However, in either case, the symbol relationship is added to the logic program.

Documenting with Symbols

Graphical Symbols can be assigned as program documentation (similar to a tag or a description) within the Edit Documentation window. This window can be accessed by any of the following:

Right-click the desired cell and select the **Modify Doc** menu item.

Click within the desired cell and press [CTRL-L].

Click within the desired cell and select the **Documentation / Modify Doc** menu item.

See *Edit Documentation Window* for details.

NOTE: Available symbols are shown depending on the available address. If no address exists, then no symbol can be viewed or edited until an address is added.

Edit Documentation window

The Edit Documentation window allows the user to choose the addition or deletion of a graphical symbol. This area is located at the bottom of the window.

To access the **Edit Documentation** window, click within the desired cell and select the **Documentation / Modify Doc** menu item, right-click the desired cell and select the **Modify Doc** menu item, or click within the desired cell and press [CTRL-L]. The **Edit Documentation** window appears.

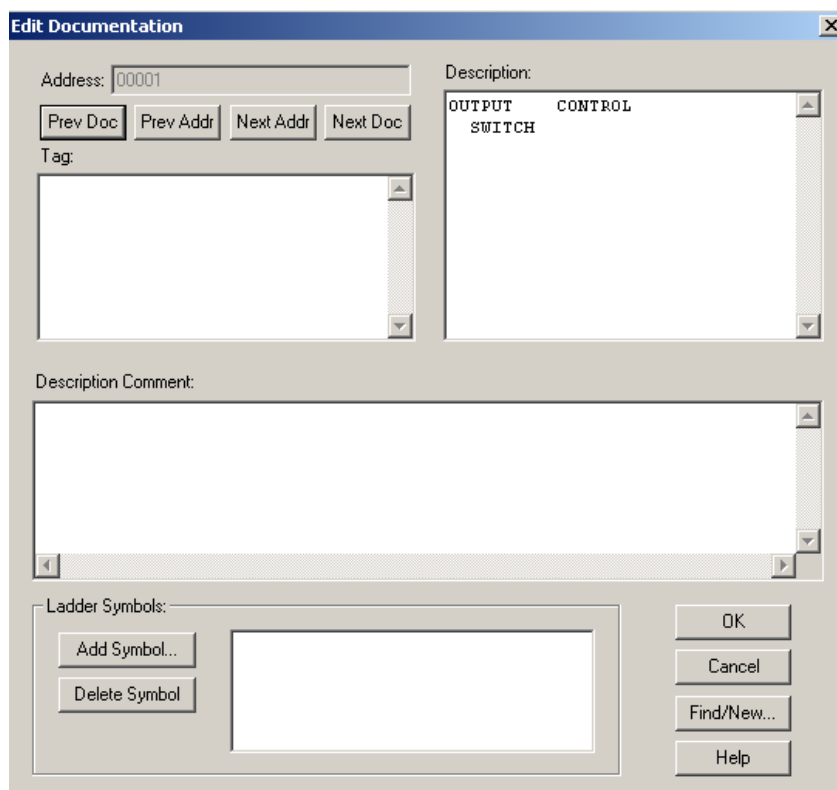

To Add a Symbol:

1. Click the **Add Symbol** button. This launches the **Symbol Library Pick** window
2. Select the desired symbol and click **OK**. If a symbol is chosen from the same library folder, and the user clicks **OK**, the user is prompted with a warning to replace any existing symbols from the same folder. The chosen symbol will then appear in the sub-window to the right of the **Add** and **Delete** button.

To Delete a Symbol:

1. Select the desired symbol from the sub-window.
2. Click the **Delete** button. The user will not be prompted to confirm a request to delete.

The Symbols Library

Graphical symbols are stored in a main library file. This file is non-editable but may be copied in to a new library file and stored wherever the user wishes. A newly created library file can be edited as well as the symbols themselves, found within the library.

Accessing the Symbol Library

To access the **Ladder Symbol Manager**, select the **View / Ladder Symbol Library** menu item. The **Symbol Library Manager** dialog appears.

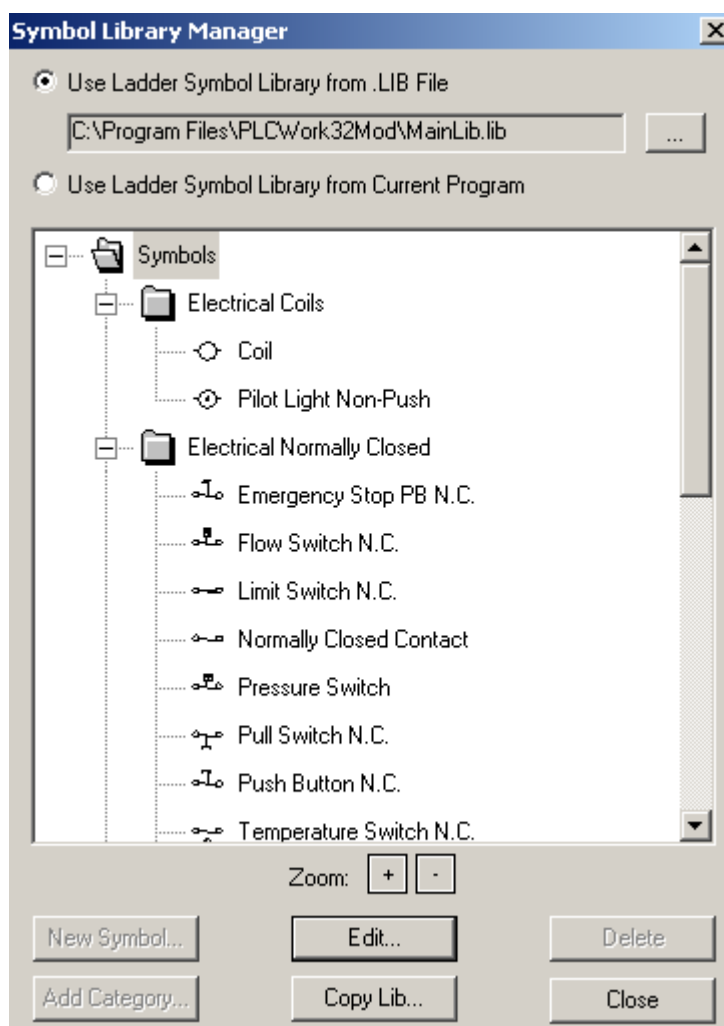

The Symbol Library manager defaults to the **Application Symbol Library**. A non-editable main library file (Mainlib.lib) is provided by WorkShop. Symbols used within a logic program are then stored to a **Program Symbol Library**, which is portable with the logic program.

Two radio buttons at the top of the Symbol Library Manager allow the user to choose between the Application Symbol Library and the Program Symbol Library. Other Library files may be chosen by clicking on the  browse button and using a *.LIB extension.

Editing, Copying, and Storing/Porting

In order to maintain a consistent library for all users, the main library file may not be edited. When a symbol or a category name is clicked on and an edit or delete operation is chosen, changes cannot be saved. Only when the main library file is copied to a new library file, can these changes be made.

To copy a library file:

1. Access the **Symbol Library Manager** dialog by selecting the **View / Ladder Symbol Manager** menu item.
2. Click the **Copy Lib** button. The **Symbol Library Transfer** dialog appears.

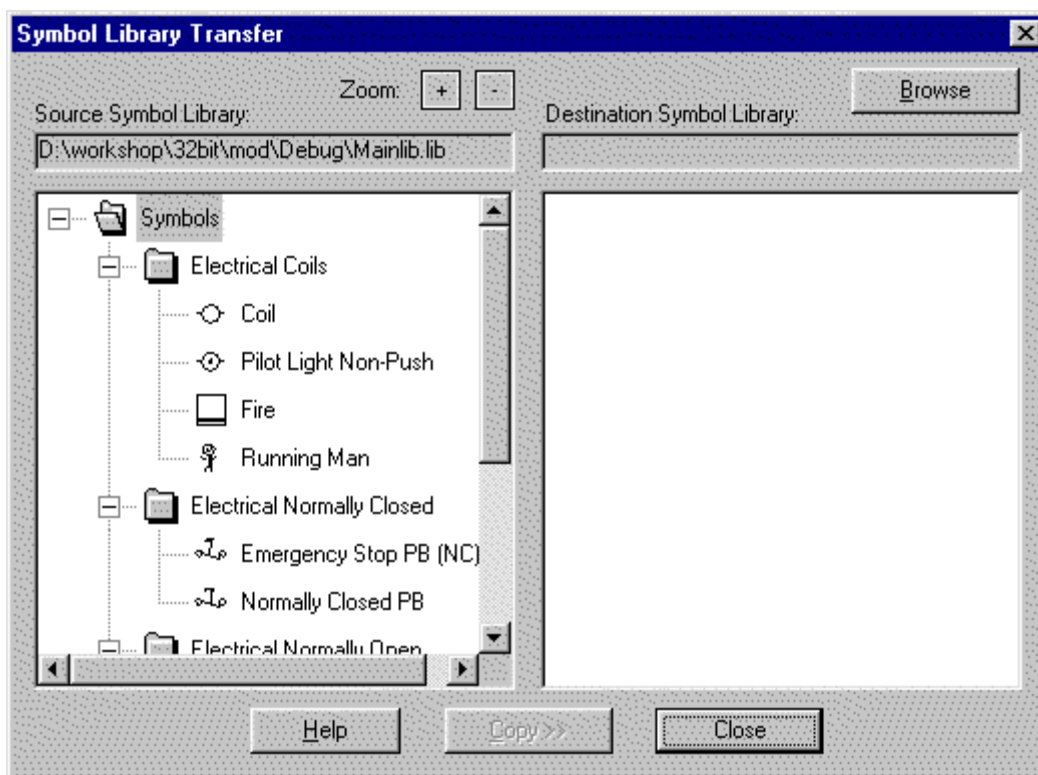

A new library file must first be created. Create a new library file by clicking **Browse**, entering a name in the **File** field of the **Open** dialog, and clicking **Open**. Individual symbols and entire categories can be chosen by clicking on them and clicking the **Copy** button near the bottom of the dialog. The user is prompted to save their changes after copying. A **Yes** will save changes; **No** will cancel the operation.

Symbols and entire categories may be deleted from the Application Symbols Library by clicking the item and then clicking the **Delete** button near the bottom of the window. Likewise, new user-specified categories can be created by clicking the **Add Category** button located near the bottom-left corner of the dialog.

Adding and Editing Symbols, Animation, metafiles

New symbols can be created, and existing symbols can be edited, within the Symbol Library Manager dialog.

To Add a New Symbol:

1. Access the Symbol Library Manager dialog by selecting the **View / Ladder Symbol Manager** menu item.
2. Click the **New Symbol** button. The **Add Symbol** dialog appears.

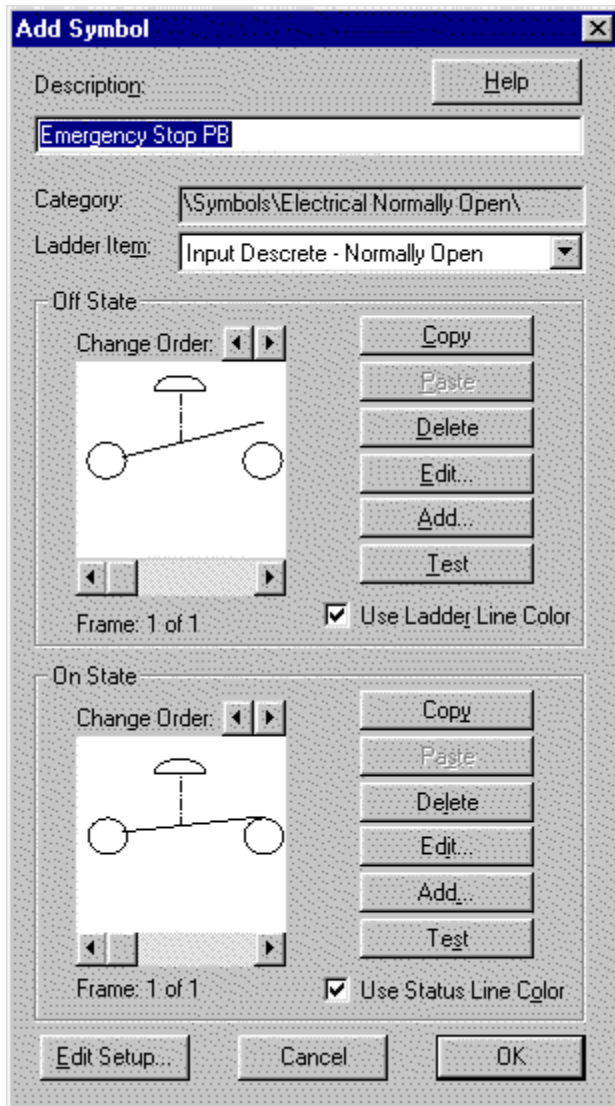
**To Edit an Existing Symbol:**

1. Access the Symbol Library Manager dialog by selecting the **View / Ladder Symbol Manager** menu item.
2. Select a symbol to edit.
3. Click the **Edit Symbol** button. The **Add Symbol** dialog appears.

NOTE: The Category field may not be changed, however, the specific Ladder Item (NO, NC, Coil) may be changed.

On and Off State Edits

Editing takes place on each active frame. The following list describes the functions of each control button used for editing.

Copy: Copies the current frame to the Windows Clipboard

Paste: Pastes current Window's Clipboard contents into the next frame from the current frame

Delete: Deletes current frame; if only one frame exists, it can not be deleted

Edit: Launches metafile editor

Add: Appends a new frame following the current frame and launches the metafile editor

Test: Runs through each frame, beginning always at the first frame

Use Ladder Line Color

Use Status Line Color

Animation Editor

The animation editor, a Window's metafile editor, can be set up using the **Edit Setup** dialog. The directory of the editor and the location of the temporary, or cache, file can be changed here. Do not rename the cache file to any existing symbol files as this file is temporary and is over-written each time it is opened in the editor.

Zoom In/Zoom Out

WorkShop allows the user to zoom in and out of the symbols within the **Symbol Library Manager**. Use the magnifying glass buttons to enlarge or decrease the size of the symbols while viewing them. This allows for a better idea of what the symbol represents.

On-line Save By Parts

If placing a file online and editing symbols, the symbols can be saved online without having to save the complete program.

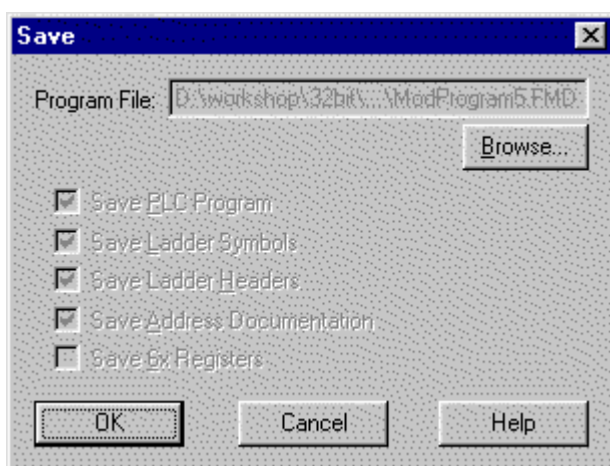

10 - Relays, Shorts, and Coils

Relay Instructions

Normally Open Contacts

Ladder Representation



Description

When the coil or discrete input to which a Normally Open contact is referenced is ON, the contact is closed and passes power. When the coil or discrete input is OFF, the Normally Open contact is open and does not pass power.

	Normally open contact	Normally closed contact
Coil or discrete input is ON	Passes power	Does not pass power
Coil or discrete input is OFF	Does not pass power	Passes power

Programming Example

This example illustrates a network with a Normally Open contact. When contact 00005 is energized, it will pass power to coil 00012.

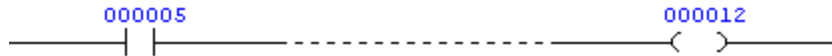

Normally Closed Contacts

Ladder Representation

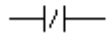

Description

When the coil or discrete input to which a Normally Closed contact is referenced is ON, the Normally Closed contact is open and does not pass power. When the coil or discrete input is OFF, the Normally Closed contact is closed and passes power. See Table 8.1.

Programming Example

This example illustrates a network with a Normally Closed contact. If contact 10016 is receiving power, it will be open and will not energize coil 00026.

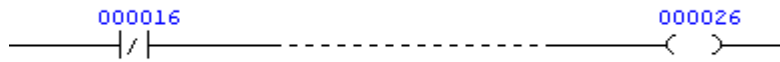

Transitional Contacts



Description

A Transitional contact is turned ON by the transition (OFF to ON, or ON to OFF) of the coil or discrete input to which it is referenced. It is not affected by the ON or OFF state of the logic coil or discrete input after the transition. When an OFF to ON (or ON to OFF) power transition is sensed by the Transitional contact, the contact provides continuity for one scan. When this one scan is complete the continuity is removed until the transition is repeated.

Programming Example

The following example illustrates the programming of the two Transitional contacts, OFF to ON and ON to OFF.

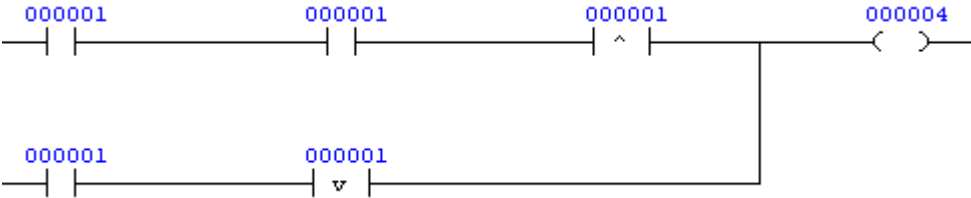

Vertical Branches and Horizontal Shorts



Description

Vertical branches and horizontal shorts are straight-line connections between instructions.

Use vertical branches to connect contacts and function blocks one above the other in a network and to connect inputs or outputs in a function block to create either/or conditions. When two contacts are connected by vertical branches (a vertical branch on each side) power is allowed to pass through if either or both contacts receive power.

Use horizontal shorts in combination with vertical branches to expand logic within a network without breaking the power flow and to create either/or conditions using basic relay contacts. For example, if one line of logic contains three relay contacts, and the line below it only contains two contacts, a horizontal short is placed in the lower line.

Coils

General Description

Use a coil to activate logic within the ladder program and/or to control an output circuit. It is represented by a 0XXXX reference number. A coil can be either a Normal coil or a Latched coil. A Latched coil implies that the power state will retain its last state after the PLC has been powered down and subsequently powered back up again.

Each 0XXXX reference can be used as a coil only once, but can be referenced by any number of relay contacts. Output coils are generally given the lower 0XXXX reference numbers and internal coils are given the higher 0XXXX reference numbers. Output and internal coil reference numbers may be intermixed since the controller is able to output any valid coil.

Displaying Coils in Ladder

Coils may be displayed in the right-most (eleventh) column or the solve column of a network. To select a display option:

1. Select the **Options / Program Setup** menu item. The **Program Setup** dialog appears.

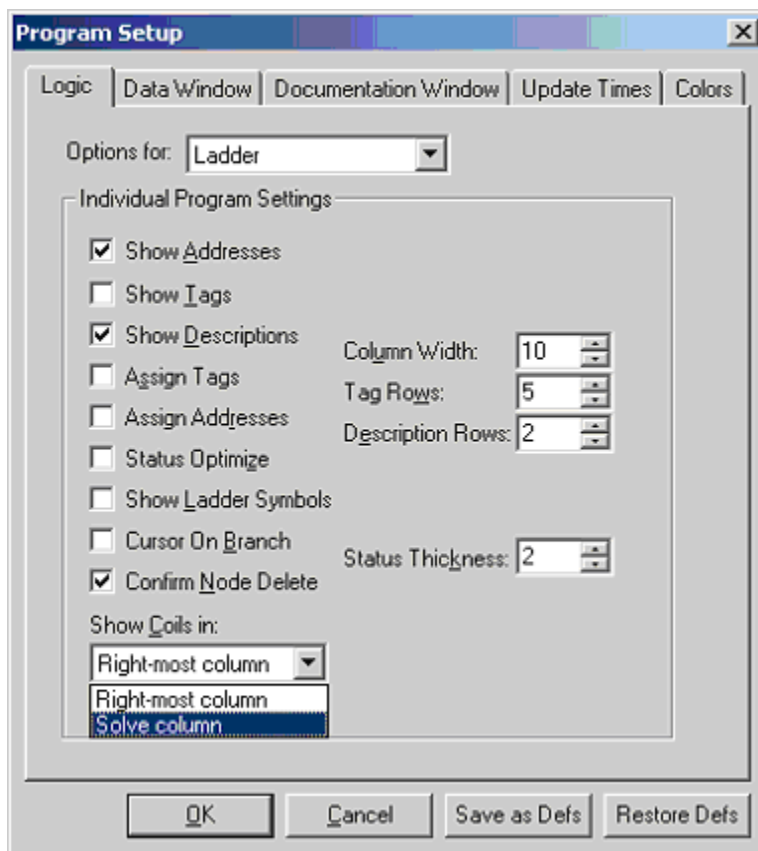

2. Select the **Logic** tab.
3. Within the **Options** for combo box, select **Ladder**.
4. Within the **Show Coils in** combo box, select **Right-most column** to display coils in the right-most column or **Solve column** to display coils in the solve columns.

NOTE: Columns in which coils are displayed cannot be changed while there is logic that has not been validated. If the **Show Coils in** setting is changed when all logic has not been validated, the coil display column setting will revert to its previous selection, and a warning message will display.

In the PLC memory, coils are actually located and solved in the column of the network in which they were programmed. Each network can contain a maximum of seven coils.

To Enter a Coil

Insert a logic coil as you would a relay contact except the cursor does not have to be over column 11. The cursor can be directly beside the last logic element in a row. When a coil is entered, dashed lines are inserted and the coil is placed in Column 11 or the solve column. These dashed lines do not exist in the PLC memory.

To Avoid Assigning Duplicate Reference Numbers

When entering coils, it is helpful to check the **Coils Used** table in order to avoid assigning the same reference number to different coils.

To display the table, select the **View / Coils Used/Unused** menu item. The **Coils Used** dialog appears.

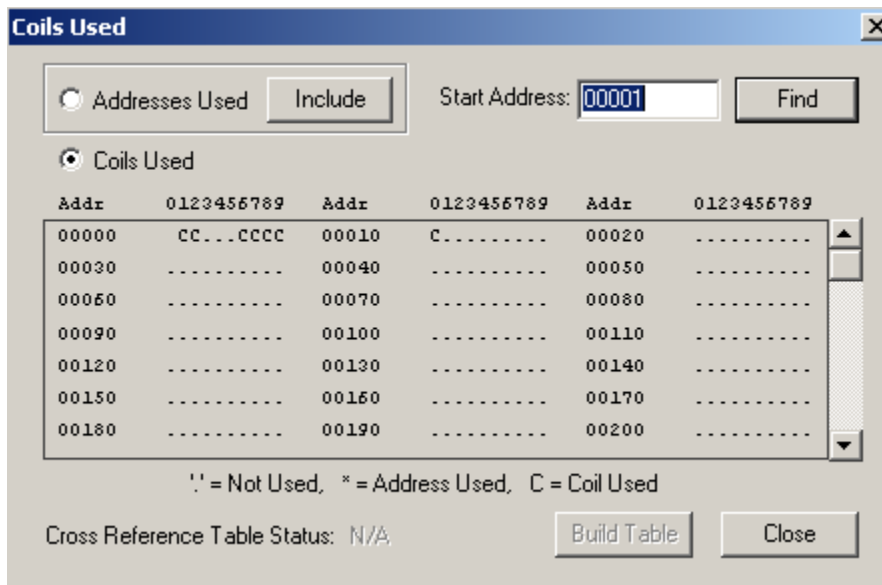

This dialog displays, in numerical order, all the reference numbers previously assigned to coils.

Normal Coil

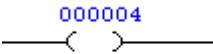

Description

A Normal coil, also referred to as a Non-Retentive coil, is turned OFF if power is removed. However, if a Normal coil is disabled, it will retain its disabled state if power is removed.

Programming Example

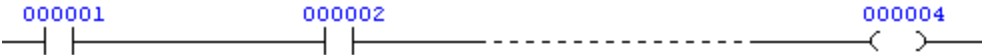

Latched Coil

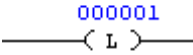

Description

A Latched coil retains its previous state if power is removed. A Latched coil is also referred to as a Retentive coil.

Programming Example

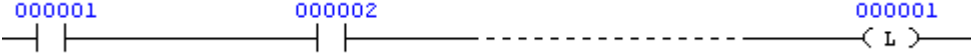

Duplicate Coils

The use of duplicate coils for valid 0x registers is configured from the PLC Configuration dialog. To access this dialog, select the **PLC Utilities / PLC Configuration** menu item. The **PLC Configuration** dialog appears.

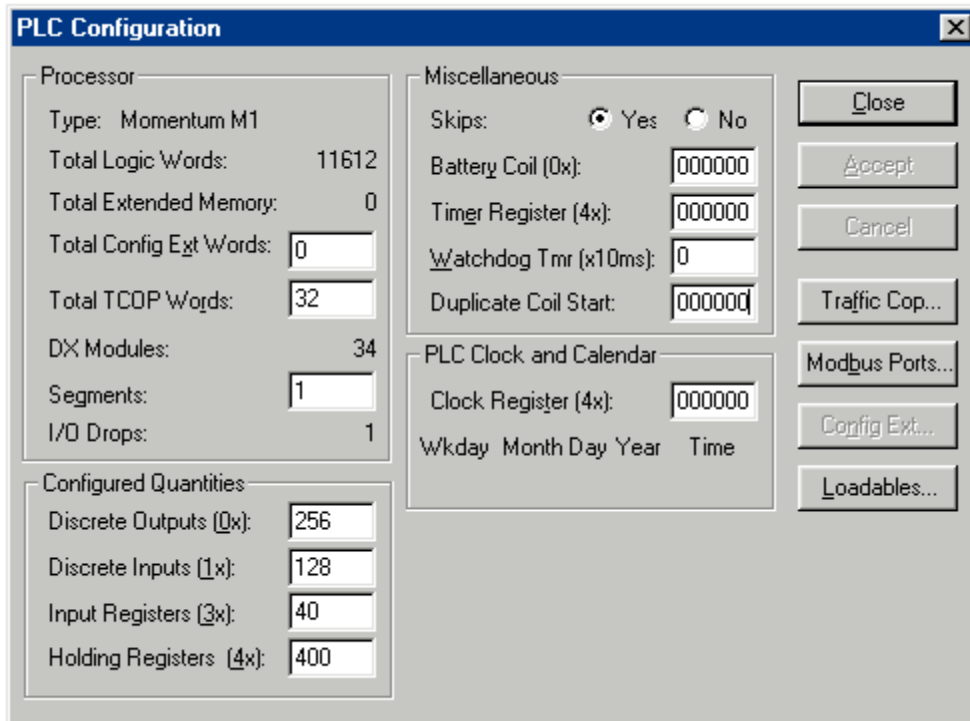

In the example above, the **Duplicate Coil Start** field is set to 000000. By default, PLC WorkShop assigns a value of 0 to the starting register. Any value greater than zero indicates the first duplicate coil register used. Any coils less than this value cannot be duplicated.

Clearing this field to allow for less duplicate coils will require that the ladder be cleared while offline in addition to clearing the PLC while online.

Program Merge and Converting Programs with Cut-and-Paste

A Program Merge will support duplicate coils. Merging into a program not having duplicate coils will skip networks that do have duplicate coils. The Merge log file is useful for analyzing what addresses were converted. However, to convert a program having duplicate coils to that of one without it is suggested to use a Cut-and-Paste. Following the validation of the program, then, PLC WorkShop will alert the user to where duplicate coils are used.

Duplicate Coils and the Coils Used, Addresses Used, and Cross Reference Tables

Assuming the configuration for a processor is set to use duplicate coils, the Coils Used Table will become invalid should a user add then delete a duplicate coil. It is suggested that either the Address Used or the Cross Reference tables be utilized.

PLC Supported

The following PLC types are supported: 381E, 385E, 480E, 485E, 685E, 785E, 785E Quantum TCOP, E258, E265, E275, E285, all Quantums, 424 VME and all M1 and M1E's.

NOBIT

Description

The Normally open bit (NOBIT) instruction lets you sense the logic state of a bit in a register by specifying a bit in its bottom node. This is representative of a normally open contact.

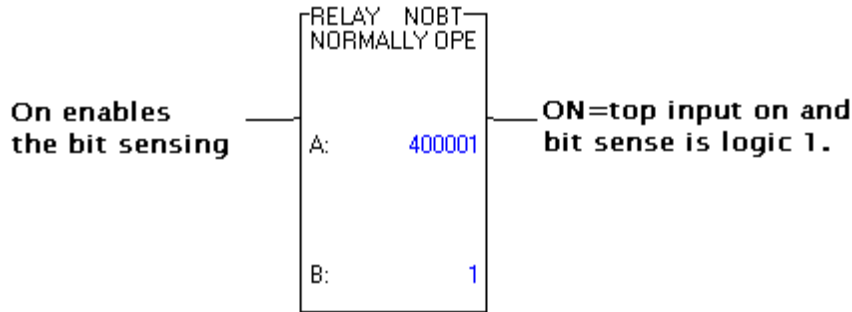

NOBIT instruction

Function Block

- Top Node** A 3x or 4x holding register whose bit pattern is being used to represent the normally open contact.
- Bottom Node** The bit number entered indicates which one of the 16 bits is being sensed.

NCBT

Description

The Normally closed bit (NCBT) instruction lets you sense the logic state of a bit in a register by specifying a bit number in the bottom node. This is representative of a normally closed contact. Power passes from the top output when the specified bit is OFF and the top input is ON.

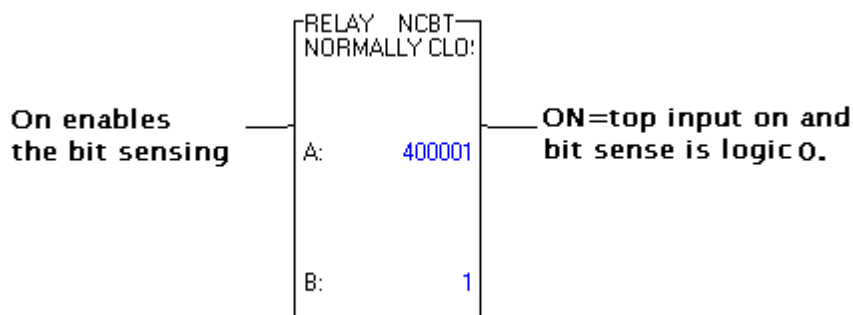

NCBT instruction

Function Block

- Top Node** A 3x or 4x holding register whose bit pattern is being used to represent the normally closed contact.
- Bottom Node** The bit number entered indicates which one of the 16 bits is being sensed.

NBIT

Description

The Normal bit (NBIT) instruction lets you control the state of a bit from a register by specifying its associated bit number in the bottom node. The bits being controlled are similar to coils. That is, when a bit is turned ON, it stays on until a control signal turns it off.

The NBIT instruction does not follow the same rules of network placement as 0x reference coils do. An NBIT instruction cannot be placed in column 11 of a network and it can be placed to the left of other logic nodes on the same rungs of the ladder.

SBIT

Description

The set bit (SBIT) instruction lets you set the state of the specified bit to ON by powering the top input.

The SBIT instruction does not follow the same rules of network placement as 0x reference coils do. An SBIT instruction cannot be placed in column 11 of a network and it can be placed to the left of other logic nodes on the same rungs of the ladder.

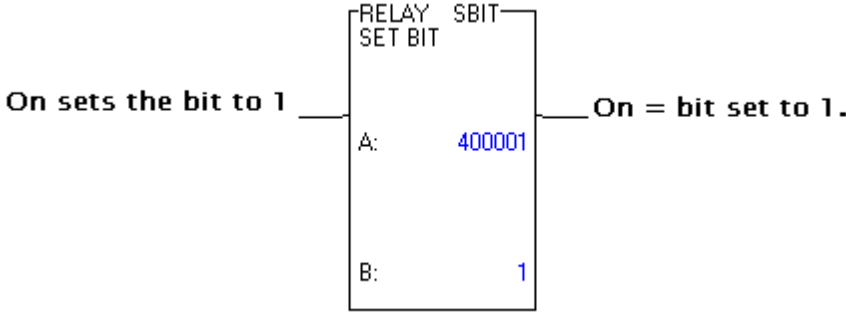

SBIT instruction

Function Block

- Top Node** The 4x register number is the holding register whose bit pattern is being controlled.
- Bottom Node** The bit number entered indicates which one of the 16 bits is being controlled

RBIT

Description

The reset bit (RBIT) instruction lets you clear a latched ON bit by powering the top input. The bit remains cleared after power is removed from the input. This instruction is designed to clear a bit set by the SBIT instruction.

The RBIT instruction does not follow the same rules of network placement as 0x reference coils do. An RBIT instruction cannot be placed in column 11 of a network and it can be placed to the left of other logic nodes on the same rungs of the ladder.

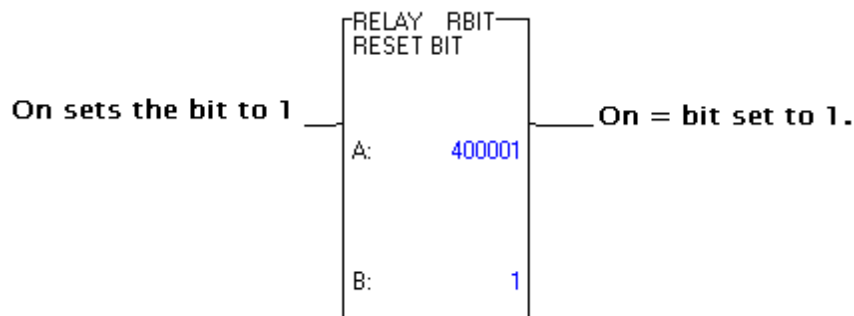

RBIT instruction

Function Block

- Top Node** The 4x register number is the holding register whose bit pattern is being controlled.
- Bottom Node** The bit number entered indicates which one of the 16 bits is being controlled

11 - Timers and Counters

Timers

Timer instructions can be used to time events or create delays in an application. The two-high node instructions are described in this section.

Ladder Representation

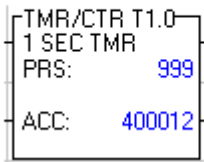

Description

Input Lines

Timing Line

Enable/
Reset Line

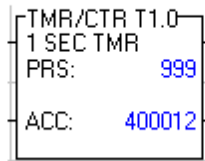

Output Lines

Timer=Preset Line

Timer < Preset Line

INPUT LINES

Timing Line The top input controls the operation. When continuity exists in the Timing line and the Timer is enabled, the Timer will time. The Timing line controls the start/stop of the Timer.

Enable/Reset Line When continuity exists in the Enable/Reset line, the Timer is enabled. If continuity does not exist in the Enable/Reset line, the Timer holding register will be cleared (set to zero).

OUTPUT LINES

Timer=Preset Decode Line The top output passes power when the Timer's accumulated value equals the preset value.

Timer<Preset Decode Line The bottom output passes power when the Timer's accumulated value is less than the preset value.

NOTE: Only one output passes power at a time.

**FUNCTION
BLOCK**

Top Node The top node represents the preset value for the Timer. It can be a constant, up to 999 in a 16-bit processor or up to 9999 in a 24-bit processor, a 3XXXX input register reference, or a 4XXXX holding register reference. The content of this register is the preset value.

For example, if the preset value is 009, it is 9.0 seconds (T1.0), 0.9 seconds (T0.1) or 0.09 seconds (T.01) depending on the time base selected. (Hint: Take the preset value and divide by 1, 10 or 100 to find the value it represents.)

Bottom Node The time base determines at what rate the Timer will time. The Timer function uses any one of three clocks to record time.

The bottom node also contains a unique 4XXXX holding register reference. This register holds the Timer's accumulated value and increases in time, starting at zero and going up to the preset value, as long as both the top and bottom inputs are receiving power.

NOTE: The controller sets the Timer value to the preset if an attempt is made to enter a value greater than the preset.

Programming Example

The following example illustrates a circuit that uses a Timer instruction.

When input 10010 is energized, the top input receives power, and since the bottom input is also receiving power, the timer is enabled and register 40012 begins accumulating time in seconds.

When the value in register 40012 equals 999 (999 seconds), the top output passes power and energizes coil 00030. The bottom input loses power when input 10011 is energized (the normally closed contact does not pass power), and the timer holding register (register 40012) value is reset to zero.

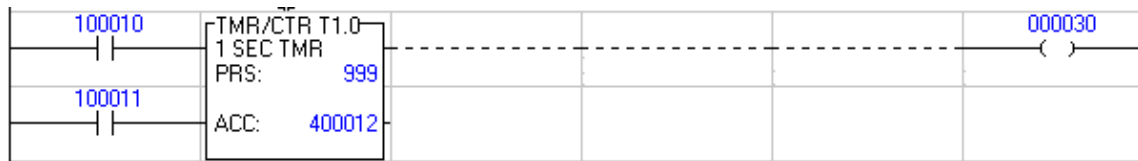

Up Counters

Ladder Representation

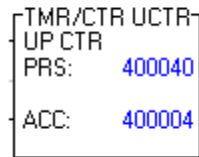

Description

The Up Counter (UCTR) function counts the OFF to ON transitions of the control input. This Counter increases by one at each positive transition of the top input.

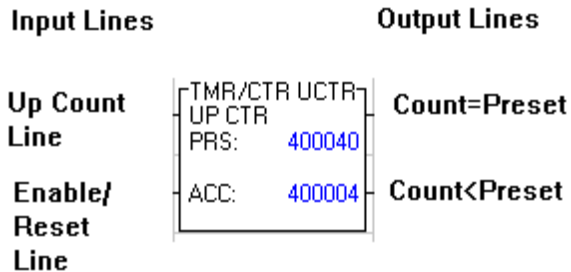

INPUT LINES

Up Count Line The top input controls the operation. When it receives a power transition from OFF to ON, the count value increases by one.

Enable/Reset Line When continuity exists in the Enable/Reset line, the Counter is enabled. If continuity does not exist in the Enable/Reset line, the Counter holding register will be cleared (set to zero) and any transitions of the Up Count line are ignored.

OUTPUT LINES

Count=Preset Decode Line The top output passes power when the Counter's accumulated value equals the preset value.

Count<Preset Decode Line The bottom output passes power when the Counter's accumulated value is less than the preset value.

NOTE: Only one output passes power at a time.

**INSTRUCTION
BLOCK**

Top Node The top node contains the preset value for the Counter. It can be a constant up to 999 in a 16-bit processor or up to 9999 in a 24-bit processor, a 3XXXX input register reference, or a 4XXXX holding register reference. The reference holds the preset value.

Bottom Node The bottom node also contains a unique 4XXXX holding register reference. This holding register contains the count value and increases, starting at zero, upon each OFF to ON transition of the control input.

NOTE: The controller sets the count value to the preset if an attempt is made to enter a value greater than the preset.

Programming Example

The following example illustrates a network using an Up Counter instruction.

When input 10040 is energized, the top input receives power, and since the bottom input is also receiving power, the Counter is enabled and counting begins. Each time input 10040 transitions from OFF to ON, the value in register 40041 increases by one.

When this value reaches the value in register 40040, the top output passes power. Coil 00040 is energized and coil 00041 is de-energized. The bottom input loses power when contact 10041 is energized (the normally closed contact does not pass power), and the Counter's accumulated value is reset to zero.

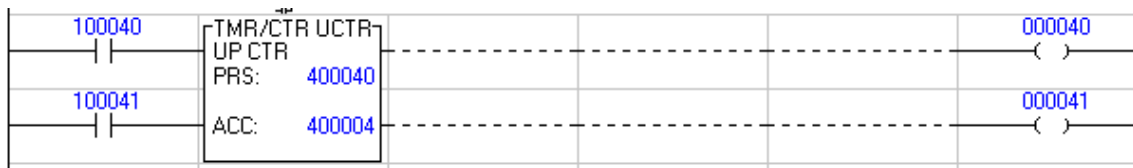

Down Counters

Ladder Representation

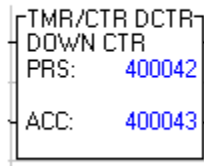

Description

The Down Counter (DCTR) function (Figure 9.3) counts the OFF to ON transitions of the control input. The Counter decreases by one upon each positive transition of the top input.

Input Lines

Output Lines

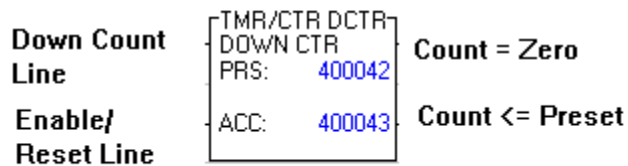

INPUT LINES

Down Count Line The top input controls the operation. When it receives power transitions from OFF to ON, the count value decreases by one.

Enable/Reset Line When continuity exists in the Enable/Reset line, the Counter is enabled. If continuity does not exist in the Enable/Reset line, the Counter holding register will be set to the preset value and any transitions of the Down Count line are ignored.

OUTPUT LINES

Count=Zero Decode Line The top output passes power when the Counter's accumulated value equals zero.

Count<=Preset The bottom output passes power when the Counter's

Decode Line accumulated value is less than or equal to the preset value.

NOTE: Only one output passes power at a time.

**FUNCTION
BLOCK**

Top Node The top node contains the preset value for the Counter. It can be a constant up to 999 in a 16-bit processor or up to 9999 in a 24-bit processor, a 3XXXX input register reference, or a 4XXXX holding register reference. The contents of these register references or holding registers is the preset value.

Bottom Node The bottom node also contains a unique 4XXXX holding register reference. This holding register contains the count value, and decreases, starting at the preset value, upon each OFF to ON transition of the control input.

NOTE:NOTE: The controller sets the count value to the preset if an attempt is made to enter a value greater than the preset.

Programming Example

The following example illustrates a network using a Down Counter instruction.

When input 10042 is energized, the top input receives power, and since the bottom input is also receiving power, the Counter is enabled and counting begins. Each time input 10042 transitions from OFF to ON, the value in register 40043 decreases by one.

When this value reaches zero, the top output passes power. Coil 00042 is energized and coil 00043 is de-energized. The bottom input loses power when contact 10043 is energized (the normally closed contact does not pass power), and the Counter's accumulated value is preset to the value in register 40042.

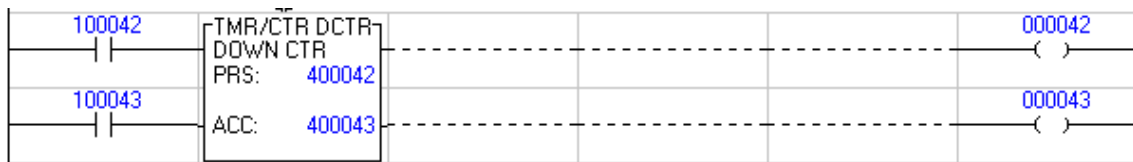

12 - Arithmetic Instructions

Arithmetic Functions

General Description

The following arithmetic functions are available: **Addition**, **Subtraction**, **Multiplication** and **Division**. All four function blocks occupy three nodes in a network and place the result of the operation in the bottom node's holding register. The top input of each function block controls the operation; when it is receiving power the function is performed.

If you are using a Modicon 351/455 processor in 484 mode, the sequencer instruction and the ADD, MUL, and DIV instructions operate differently. The differences for the ADD, MUL, and DIV instructions are identified in this chapter. Sequencers, along with information about the 484 mode.

Addition Function

Ladder Representation

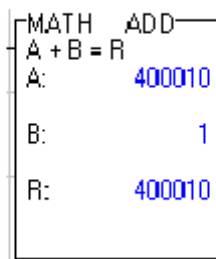

Description

The Addition (ADD) function (Figure 10.1) adds two values together and places the sum in a holding register.

Input Lines

Output Lines

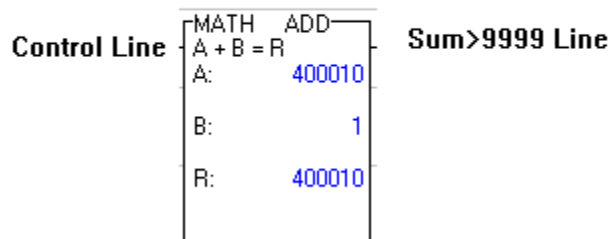

INPUT LINES

Control Line The top input controls the operation. When it receives power, the value in the top node is added to the value in the middle node and the sum is placed in the bottom node's holding register.

OUTPUT LINES

Sum>9999 Decode Line The top output passes power when the sum is greater than 9999 (999 if in 484 mode); it indicates that a 1 should be placed in front of the result located in the holding register.

NOTE: Only the top input and top output are used for this function.

FUNCTION BLOCK

Top Node The top node contains a value that can be a constant up to 999 in a 16-bit processor or 484 mode and up to 9999 in a 24-bit processor, a 3XXXX input register reference, or a 4XXXX holding register reference.

Middle Node The middle node contains a value that can be a constant up to 999 in a 16-bit processor or 484 mode and up to 9999 in a 24-bit processor, a 3XXXX input register reference, or a 4XXXX holding register reference.

Bottom Node The bottom node contains the 4XXXX holding register reference. This holding register holds the sum of the top and middle node values.

Instruction Example

Figure 10.2 illustrates an Addition instruction. If the content of register 40010 is 9999, the result placed in register 40010 is 0000 and the top output passes power. The top input of the second ADD block receives power. This function adds a one to register 40009 so the sum of the two numbers is read properly. If the content of register 40009 is greater than 9999, the top output of the second block passes power, energizing coil 00102.

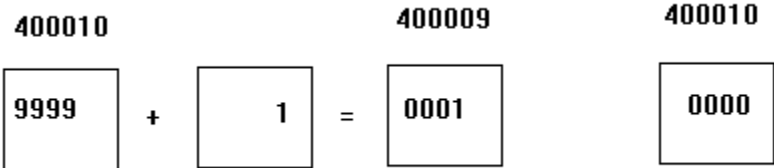

NOTE: The ADD block may give incorrect results with sums over 20,000.

Programming Example

The following programming example shows a circuit with an Addition function.

When input 10101 is energized, the top input of the first ADD block receives power and the content of register 40010 is added to the fixed value 00001. The sum is placed in register 40010.

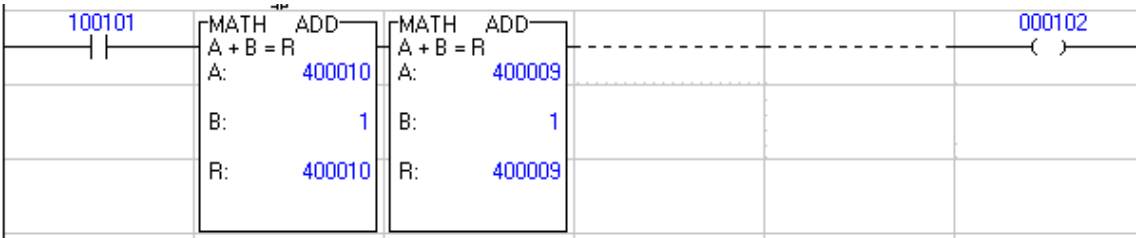

Subtraction Functions

Ladder Representation

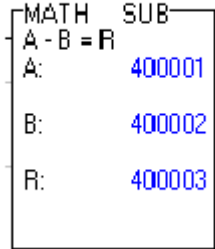

Description

The Subtraction (SUB) function subtracts one value from another and places the absolute value of the difference in a holding register.

Input Lines

Output Lines

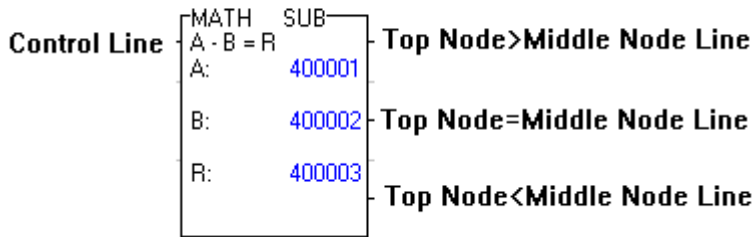

INPUT LINES

Control Line The top input controls the operation. When it receives power, the value in the middle node is subtracted from the value in the top node and the difference is placed in the bottom node's holding register.

OUTPUT LINES The use of any or all outputs is optional. Two outputs can be connected together with vertical branches to create a greater than or equal to function using the top and middle outputs, or a less than or equal to function using the middle and bottom outputs.

Top Node > Middle Node Decode Line The top output passes power when the value in the top node is greater than the value in the middle node.

Top Node = Middle The middle output passes power when the value in the top

Node Decode Line node equals the value in the middle node.

Top Node<Middle Node Decode Line The bottom output passes power when the value in the top node is less than the value in the middle node.

FUNCTION BLOCK

Top Node The top node contains a value that can be a constant up to 999 in a 16-bit processor and up to 9999 in a 24-bit processor, a 3XXXX input register reference, or a 4XXXX holding register reference. The value in the middle node is subtracted from this value when the control input receives power.

Middle Node The middle node contains a value that can be a constant up to 999 in a 16-bit processor and up to 9999 in a 24-bit processor, a 3XXXX input register reference, or a 4XXXX holding register reference. This value is subtracted from the value in the top node.

Bottom Node The bottom node contains the 4XXXX holding register reference. This holding register contains the difference between the top and middle node values.

Function Example

Figure 10.4 illustrates an example Subtraction function. If the value in 40001 is 9000 and the value in 40002 is 0500, the result placed in 40003 is 8500.

40001		40002		40003
9000	-	500	=	8500

NOTE: The value placed in register 40003 is the absolute value of the difference; no sign is associated with the content of register 40003.

Programming Example

The following programming example illustrates a network with a Subtraction function.

When contact 00080 is energized, the top input of the function block receives power and the subtraction is performed. The value in register 40002 is subtracted from the value in register 40001 and the result is placed in register 40003.

If the value in 40001 is greater than the value in 40002, the top output passes power and energizes coil 00011. This indicates a normal Subtract function.

If the value in 40001 is equal to the value in 40002, the middle output passes power and energizes coil 00012. This indicates a difference of zero.

If the value in 40001 is less than the value in 40002, the bottom output passes power and energizes coil 00013. This indicates that the answer to the Subtract function is negative.

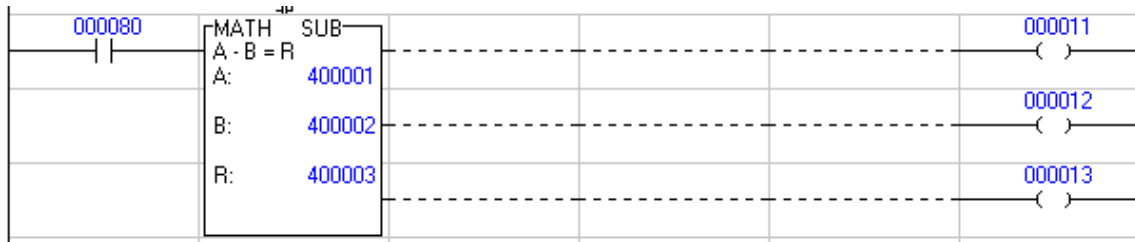

Multiplication Function

Ladder Representation

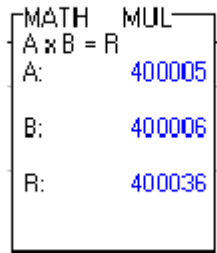

Description

The Multiplication (MUL) function (Figure 10.5) calculates the product of two values and places the answer in two consecutive holding registers. Two consecutive holding registers are used because the product of two 4-digit numbers can be up to 8 digits in length.

Input Lines

Output Lines

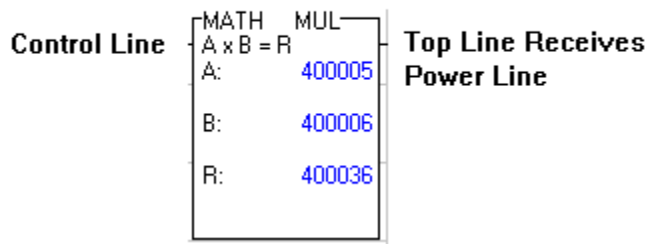

INPUT LINE

Control Line The top input controls the operation. When it receives power, the value in the top node is multiplied by the value in the middle node and the product is placed in the bottom two consecutive holding registers.

OUTPUT LINE

Top Input Receives Power Decode Line The top output passes power when the top input receives power. This allows the function blocks to be cascaded within a network.

NOTE: Only the top input and top output are used for this function.

**FUNCTION
BLOCK**

- Top Node** The top node contains a value that can be a constant up to 999 in a 16-bit processor or 484 mode and up to 9999 in a 24-bit processor, a 3XXXX input register reference, or a 4XXXX holding register reference. The value of the top node is multiplied with the value of the middle node.
- Middle Node** The middle node contains a value that can be a constant up to 999 in a 16-bit processor or 484 mode and up to 9999 in a 24-bit processor, a 3XXXX input register reference, or a 4XXXX holding register reference. The value of the middle node is multiplied with the value of the top node.
- Bottom Node** The bottom node contains the 4XXXX holding register reference. This holding register holds the high order portion of the product even if it is zero. The next consecutive holding register (4XXXX+1) holds the low order portion of the product. For this reason, the last available holding register cannot be used.

Function Example

Figure 10.6 is an illustration of an example Multiplication function. If registers 40005 and 40006 contain the values 2500 and 1110 the product is 2,775,000. Thus, register 40036 is loaded with the value 0277 and register 40037 is loaded with the value 5000. The two registers are multiplied and the product is stored every scan that input 10007 is energized.

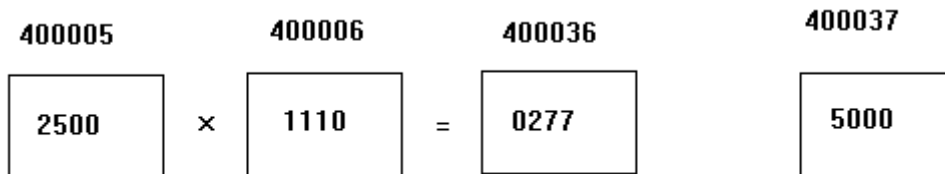

Programming Example

The following programming example illustrates a network with a Multiplication function.

When input 10007 is energized, the top input receives power and the value in register 40005 is multiplied by the value in register 40006 and coil 00102 is energized. The resulting product is stored in registers 40036 and 40037.

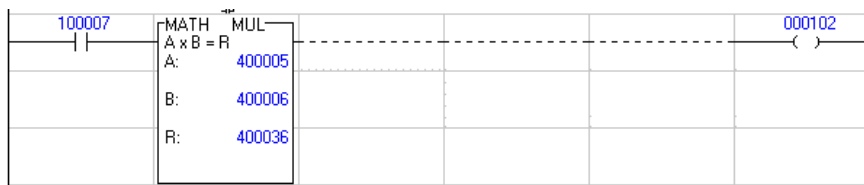

Division Function (DIV)

Ladder Representation

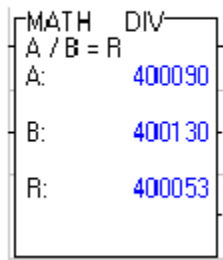

Description

The Division (DIV) function divides one value by another value and places the quotient and remainder in holding registers. If you are in 484 mode, the remainders are discarded. Otherwise, the remainder is stored in the register following the dividend register. If the 484 mode is off, the destination register cannot be the last configured register.

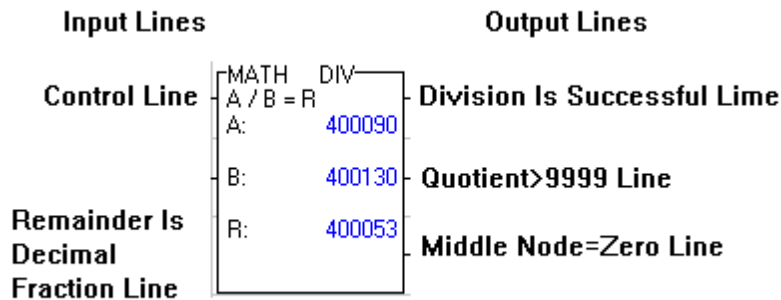

INPUT LINES

Control Line The top input controls the operation. When it receives power, the value in the top node is divided by the value in the middle node and the quotient and the remainder are placed in two consecutive holding registers.

Remainder Is Decimal Fraction Line The middle input, when receiving power, causes the remainder to be a decimal fraction. If it does not receive power, the remainder is a whole number. For example, 10 divided by 3 has a decimal remainder of .3333 and a whole number remainder of 1.

OUTPUT LINES

Division Is The top output passes power when the division is successful.

- Successful Decode Line** If the middle or bottom outputs pass power, the division is unsuccessful and the top output does not pass power.
- Quotient>9999 Decode Line** The middle output passes power when the quotient is greater than 9999 (999 in 484 mode). If this output passes power, zeros are placed in the bottom node's holding registers.
- Middle Node=Zero Decode Line** The bottom output passes power when the divisor (middle node) equals zero. If this output passes power, zeros are placed in the bottom node's holding registers.
- Top Node** The top node is the dividend. It can be a constant, up to 999 in a 16-bit processor and if you are in 484 mode or up to 9999 in a 24-bit processor, a 3XXXX input register reference, or a 4XXXX holding register reference. Two consecutive registers are used and both are needed for a double precision number. If a single precision number is desired and registers are being used, fill the first register with zeros. When a register reference is used, the next register is implied; therefore, the last available register, input or holding, cannot be used in this node.
- Middle Node** The middle node is the divisor. It contains a constant, up to 999 in a 16-bit processor and in 484 mode or up to 9999 in a 24-bit processor, a 3XXXX input register reference, or a 4XXXX holding register reference.
- Bottom Node** The bottom node contains the 4XXXX holding register reference. This holding register holds the result of the division. The next holding register (4XXXX+1) holds the remainder; therefore, the bottom node cannot contain the last available holding register.

Function Example

Figure 10.8 is an illustration of a Divide instruction. If the double precision number is 1,234,567 (40090=0123, 40091=4567) and the divisor (40130) is 0236, the value 5231 is placed in register 40053 and the decimal remainder 2161 is placed in register 40054.

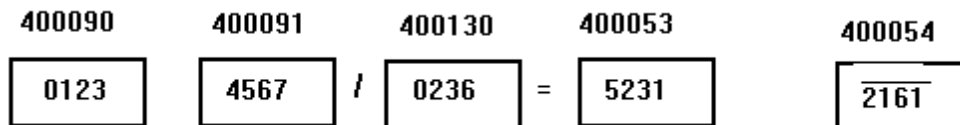

Programming Example

The following programming example illustrates a network with a Divide function.

When contact 00005 is energized, the top input receives power and the contents of registers 40090 and 40091 (double precision number) are divided by the contents of register 40130. The result is placed into register 40053 and the remainder into register 40054. Since the middle input is receiving power, the remainder is a decimal fraction rather than a whole number.

If the middle input was not receiving power, the whole remainder 0051 would be placed in register 40054.

Coil 00035 is energized if the division is successful.

Coil 00065 is energized if the quotient is greater than 9999.

Coil 00095 is energized if the divisor (middle node) equals zero.

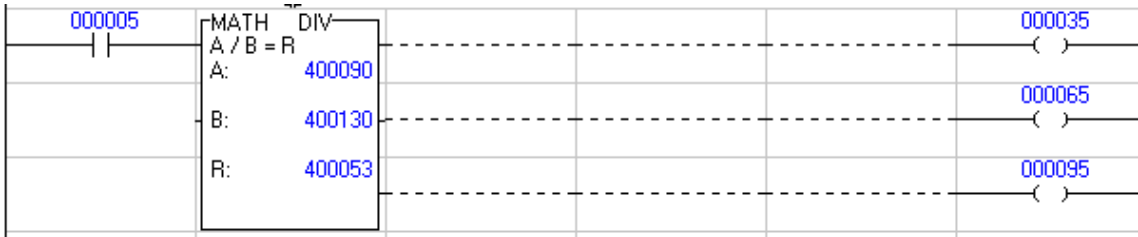

13 - Transfer and Move Instructions

Data Transfer Functions

General Description

This section describes the following functions:

Register to Table Move (R -> T)

Table to Register Move (T -> R)

Table to Table Move (T -> T)

Block Move (BLKM)

Search (SRCH)

Load Instruction Block

Save Instruction Block

A **register** is a location in the controller's memory in which a numerical binary value is stored. A **table** is a group of consecutive registers or discretes. Use the Move functions to copy data from registers and/or tables. You can then examine or change the copied data without altering the original contents.

Each Move function block except STAT occupies three nodes in an eleven-by-seven-node network format. The function block consists of a source node, a destination node, and a node specifying table length. The top input is the control input; when it receives power the function is performed. The top output passes power when the top input receives power, allowing function blocks to be cascaded within a network. The input(s) to a Move function block can be a single relay contact, another function block, or a whole network of logic. The output(s) can be connected directly to coils, to other function blocks, to relay contacts, or left unconnected.

The Move function blocks can perform functions with 3XXXX input registers, 4XXXX holding registers, and 0XXXX and 1XXXX discrete references. Inputs are only allowed as the source.

Use the following guidelines if using discrete references:

1. Discretes are used in groups of 16.
2. The reference number used is the first in the group; the other 15 references are implied.
3. Only certain reference numbers are valid; the number must be divisible by 16 with a remainder of 1. The valid reference numbers are: 00001, 00017, 00033, etc., and 10001, 10017, 10033, etc.
4. The table length value refers to the number of groups of 16 discretes (for example, 4 indicates 4 groups or 64 discretes).
5. If a 0XXXX reference is used in a Data Transfer function block as the destination, it cannot be used anywhere else in the program.

Register-to-Table Move (R->T)

Ladder Representation

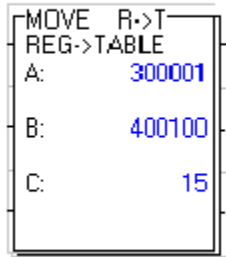

Description

The Register-to-Table (R->T) Move function copies 16 logic coils, 16 discrete inputs, one input register, or one holding register into a single specific location within a table of registers.

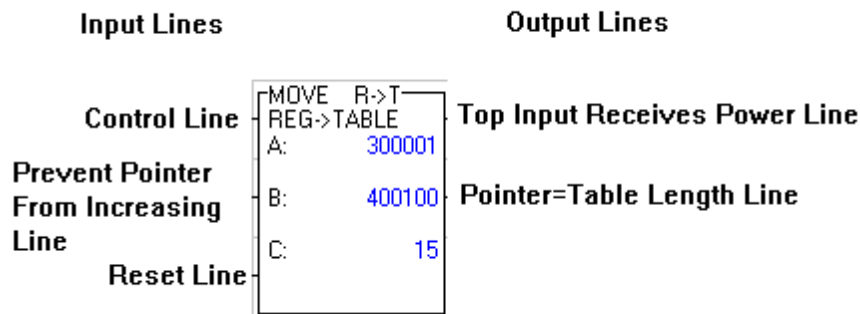

INPUT LINES

Control Line The top input controls the operation. When it is receiving power, the information in the source register is copied into a location in the table.

Prevent Pointer From Increasing Line The middle input, when receiving power, prevents the pointer from increasing.

Reset Line The bottom input, when receiving power, resets the pointer to zero. If the top input is also energized, the source register is copied to the first register in the table.

OUTPUT LINES

Top Input Receives Power The top output passes power when the top input receives power.

Decode Line

Pointer=Table Length Decode Line

The middle output passes power when the pointer equals the table length. This indicates that the table is full (end of table).

FUNCTION BLOCK

Top Node

The top node is the source node. It can be one of the following references: a 0XXXX logic coil, a 1XXXX discrete input, a 3XXXX input register, or a 4XXXX holding register. The source is a single 16-bit location (e.g., a register or group of 16 discretetes).

Middle Node

The middle node is the destination node. It is a 4XXXX holding register that holds the pointer value. The pointer value plus one indicates the position of a register in a table (i.e., a pointer value of three indicates the fourth position in a table). The table starts at the next register (4XXXX+1), not at the pointer.

Bottom Node

The bottom node contains the numerical value that specifies the table length. This constant can range from 1 to 255 for 16-bit or from 1 to 999 for 24-bit.

Function Example

The following diagram illustrates the Register-to-Table Move function described in Programming Example below.

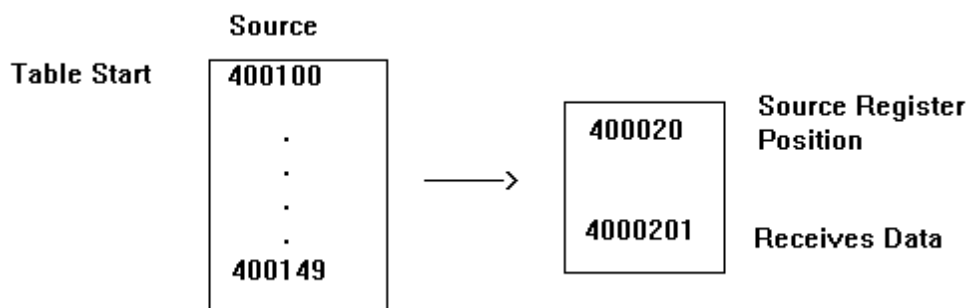

Programming Example

When input 10034 is energized, the top input receives power and the contents of input register 30001 is moved into table 40101-40115. Data is moved one entry per scan. If the pointer value equals zero when the top input receives power, the contents of register 30001 is moved into register 40101 and the pointer value increases to one.

On the next scan, provided the top input is still receiving power, the contents of register 30001 is moved into register 40102 and the pointer value increases to two. Whenever the top input loses power, the Move operation stops and the pointer holds its value.

Once the pointer has increased to the table size as defined in the bottom node (15), the middle output passes power and energizes coil 00067. On the next scan, the bottom input receives power because it is referenced to coil 00067. This input resets the pointer to zero, thereby de-energizing coil 00067.

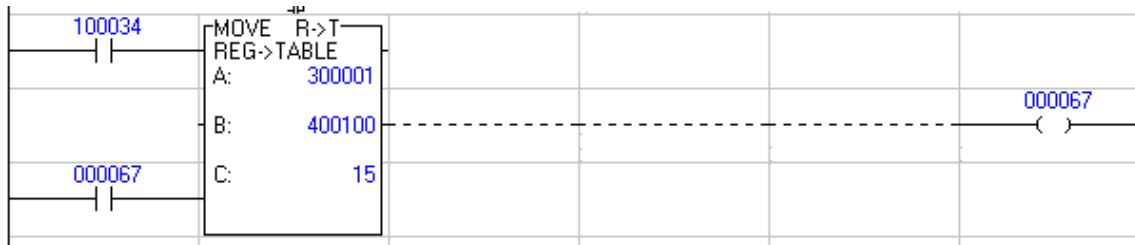
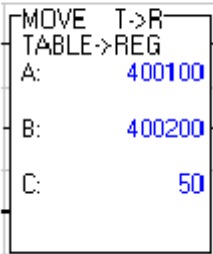

Table-to-Register Move (T ->R)

Ladder Representation



Description

The Table-to-Register Move function copies one register or group of 16 discrettes from a table into a single holding register.

Input Lines

Output Lines

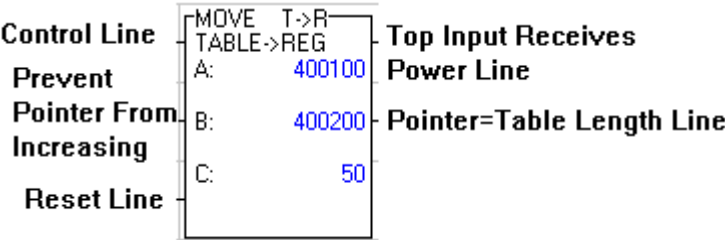

INPUT LINES

Control Line The top input controls the operation. When it is receiving power, the information in the source table’s register is copied into a single holding register.

Prevent Pointer From Increasing Line The middle input, when receiving power, prevents the pointer from increasing.

Reset Line The bottom input, when receiving power, resets the pointer to zero. If the top and bottom inputs are energized at the same time, the first register in the table is moved to the destination register.

OUTPUT LINES

**Top Input
Receives Power
Decode Line** The top output passes power when the top input receives power.

**Pointer=Table
Length Decode
Line** The middle output passes power when the pointer value equals the table length (end of table).

**FUNCTION
BLOCK**

Top Node The top node is the source Node. It can be one of the following references: a 0XXXX logic coil, a 1XXXX discrete input, a 3XXXX input register, or a 4XXXX holding register. The source is a table of 16 bit locations. Its size is defined in the bottom node.

Middle Node The middle node is the destination node. It is a 4XXXX holding register that holds the pointer value. The pointer value plus one indicates the position of a register in a table (i.e., a pointer value of three indicates the fourth position in a table). The next consecutive holding register (4XXXX+1) receives the data. The pointer does not receive the data.

Bottom Node The bottom node contains a numerical value that specifies the table length. This constant can range from 1 to 255.

Function Example

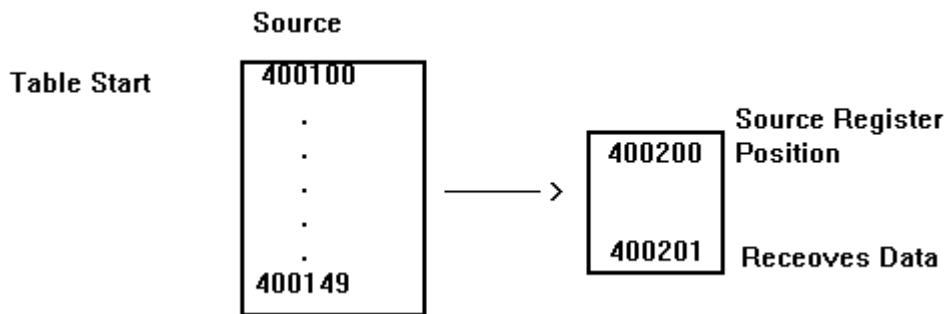

Programming Example

When input 10054 is energized, the top input receives power and the content of the table starting at 40100 is moved into register 40201. Data is moved one register per scan. The pointer value increases after each move.

If the pointer value equals zero when the top input receives power, the content of register 40100 is moved into 40201 and the pointer value (register 40200) increases by one.

On the next scan, if the top input is still receiving power, the content of register 40101 is moved into 40201 (the same register as before) and the pointer value (register 40200) increases to two. On this second scan, the value of register 40101 takes the place of the value of 40100 in register 40201.

When input 10054 is energized, the top input receives power and the register moved is 40100 plus the pointer value (e.g., if the pointer value in register 40200 is 32, the register moved is 40132).

When the pointer register 40200 equals 50, coil 00129 is energized. The bottom input is energized because it is referenced to coil 00129. The pointer is reset to zero, thereby de-energizing coil 00129.

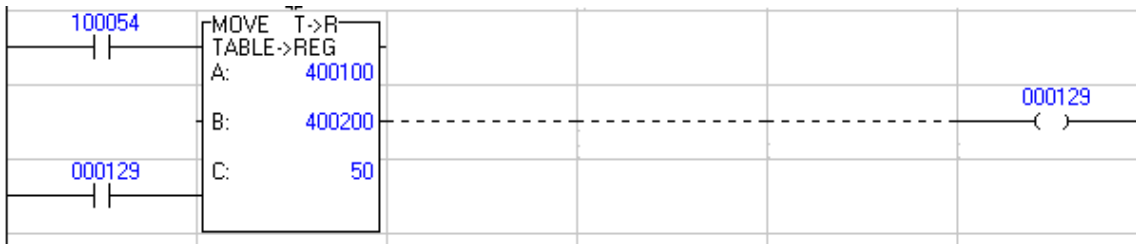
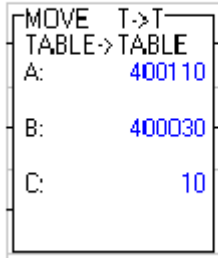

Table-to-Table Move (T ->T)

Ladder Representation



Description

The Table-to-Table Move function copies discretetes from one table to a table of holding registers.

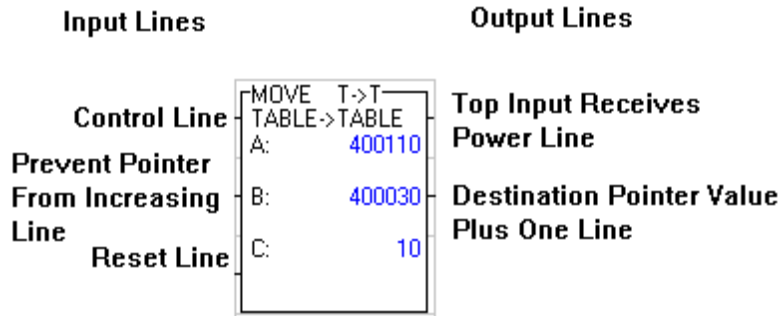

INPUT LINES

Control Line The top input controls the operation. When it is receiving power, the information in one register of the source table is copied into the corresponding register in the destination table.

Prevent Pointer From Increasing Line The middle input, when receiving power, prevents the pointer from increasing.

Reset Line The bottom input, when receiving power, resets the pointer to zero. If the top and bottom inputs are energized at the same time, the first register in the source table is moved to the first register in the destination table.

OUTPUT LINES

Top Input Receives Power The top output passes power when the top input receives power.

Decode Line

**Destination
Pointer Value Plus
One Decode Line** The middle output passes power when the pointer value equals the table length (end of table).

**FUNCTION
BLOCK**

Top Node The top node is the source node. It can be one of the following references: a 0XXXX logic coil, a 1XXXX discrete input, a 3XXXX input register, or a 4XXXX holding register. The source is a table of 16 bit locations. Its size is defined in the bottom node.

Middle Node The middle node is the destination node. It is a 4XXXX holding register that holds the pointer value. The pointer value plus one indicates the position of a register in a table (i.e., a pointer value of three indicates the fourth position in a table). The table starts at the next register (4XXXX+1), not at the pointer.

Bottom Node The bottom node contains the numerical value that specifies the length for both tables. This constant can range from 1 to 255 for 16-bit and 999 for 24-bit.

Function Example

The following is an illustration of the Table-to-Table Move described in Programming Example below.

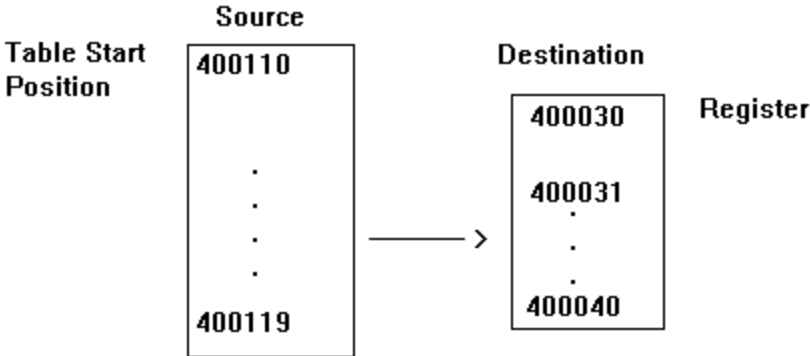

Programming Example

The following programming example illustrates a network with a Table-to-Table Move instruction.

When input 10044 is energized, the top input receives power. A register from the table which starts at register 40110 is moved into the register at the corresponding position in the table that starts at 40031. Register 40030 holds the pointer value.

One register is moved per scan and the pointer value increases by one on each scan. The middle output passes power when the pointer value equals the table size, 10 in this example, thus energizing coil 00031. On the next scan, the bottom input receives power because it is referenced to coil 00031. The pointer value is reset to zero; therefore, coil 00031 is de-energized OFF.

At the start of the move, if the pointer is at zero, the contents of register 40110 is copied into register 40031, and the pointer increases to one. On the next scan, register 40111 is copied into register 40032, and the pointer increases to two. If the function block stops receiving power, the pointer holds its value and recalls it when power is returned.

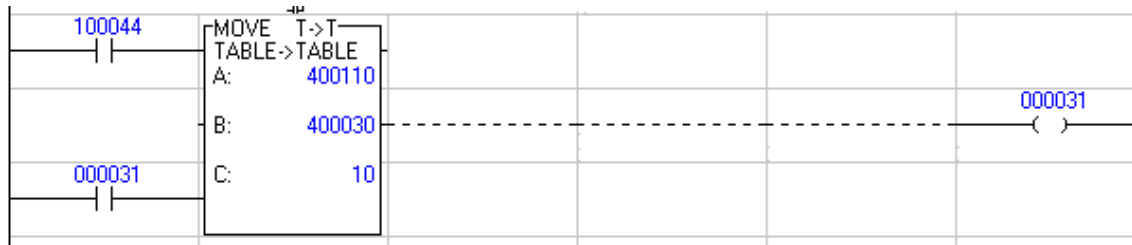

Block Move (BLKM)

Ladder Representation

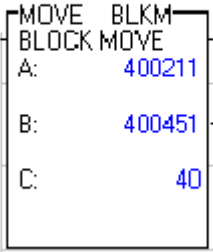

Description

The Block Move function copies the entire contents of a table of registers or discretetes into another table. The entire Move takes place in one scan.

Input Lines

Output Lines

Control Line

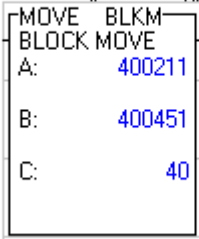

Top Input Receives Power Line

IBKR

Description

The Indirect block read (IBKR) instruction allows you to access non-contiguous registers dispersed throughout your application and copy the contents into a destination block of contiguous registers. This instruction can be used with subroutines or for streamlining data access by host computers or other PLCs'.

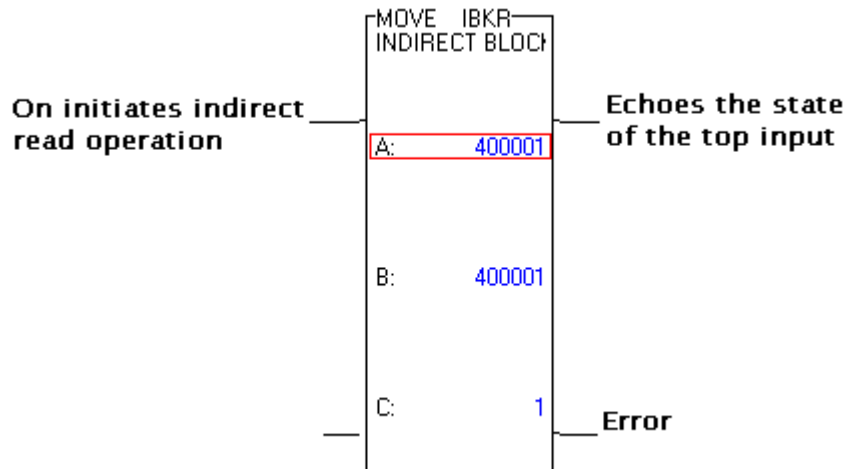

Function Block

Top Node

The 4x register is the first holding register in a source table. The registers in this table contain values that are pointers to the non-contiguous registers you want to collect in the operation.

Middle Node

The 4x register is the first in a block of contiguous destination registers.

Bottom Node

The value entered indicates the length (the number of registers in the source table).

IBKW

Description

The Indirect block write (IBKW) instruction lets you copy the data from a table continuous registers into several non-contiguous registers dispersed throughout your application.

Input Lines Output Lines

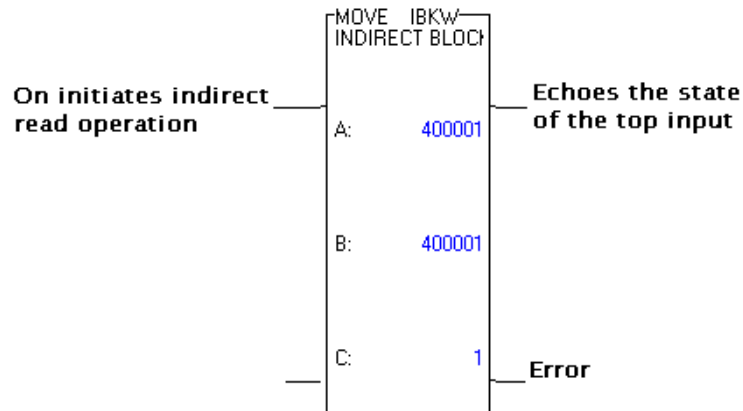

Function Block

Top Node

The 4x register is the first holding register in a source table. The registers in this table contain values that are pointers to the non-contiguous registers you want to collect in the operation.

Middle Node

The 4x register is the first in a block of contiguous destination registers.

Bottom Node

The value entered indicates the length (the number of registers in the source table).

Table Search Operation (SRCH)

Ladder Representation

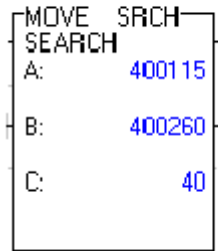

Description

The Table Search (SRCH) function searches a table of registers for a specified value. When a matching value is found, the operation stops and the pointer value indicates the register where the match is located.

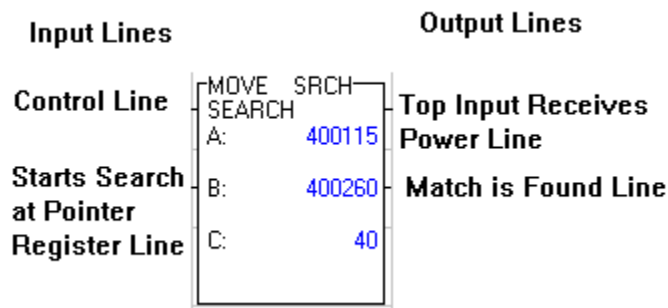

INPUT LINES

Control Line

The top input controls the operation. When it receives power, each register in a table is examined to see if it contains a specified value. The search begins at the first register in a table unless the middle input is receiving power and the pointer value is greater than zero.

Start Search at Pointer Register Line

The middle input, when it receives power, begins the search operation at the register whose location is specified in the pointer register, or continues the search operation from the register in which the match was found. If the pointer value is greater than zero and the middle input does not receive power, the search begins at the first register in the table.

OUTPUT LINES**Top Input
Receives Power
Decode Line**

The top output passes power when the top input receives power.

**Match Is Found
Decode Line**

The middle output passes power when a match is found. If no match is found in the scan of an entire table, this output does not pass power and the pointer is reset to zero.

**FUNCTION
BLOCK****Top Node**

The top node is the source node. It can be either a 3XXXX input register reference or a 4XXXX holding register reference. This register specifies the first register of a table.

Middle Node

The middle node is the destination node. It is a 4XXXX holding register, which is used as a pointer and also holds the pointer value. This value indicates the location of the register containing a match. The next consecutive holding register, 4XXXX+1, contains the value being searched for. This value can be a 4-digit number up to 9999 in a 584L PC, a 3-digit number up to 999 in a 984 PC, a 16 bit binary pattern, or two ASCII characters.

Bottom Node

The bottom node contains the numerical value that specifies the table length. This constant can range from 1 to 100.

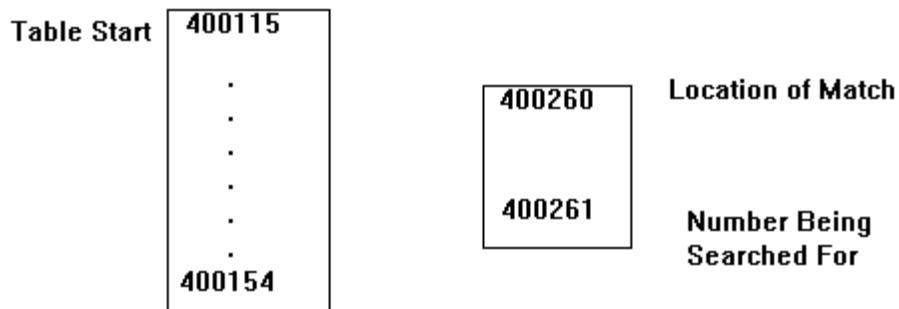
Instruction Example

Programming Example

The following programming example illustrates a network with a Table Search function.

When contact 00013 is energized, the top input receives power. The table, which starts at register 40115, is searched to see if it holds the same value as in register 40261. Register 40260 holds the pointer value.

If a match is found, the search stops, the position number of the register is placed in 40260, and the middle output passes power.

To search for additional matches, both the top and middle inputs must receive power. If this condition is true, the search continues at the next consecutive register after the one containing a match. If no match is found, the middle output does not pass power and the pointer is reset to zero.

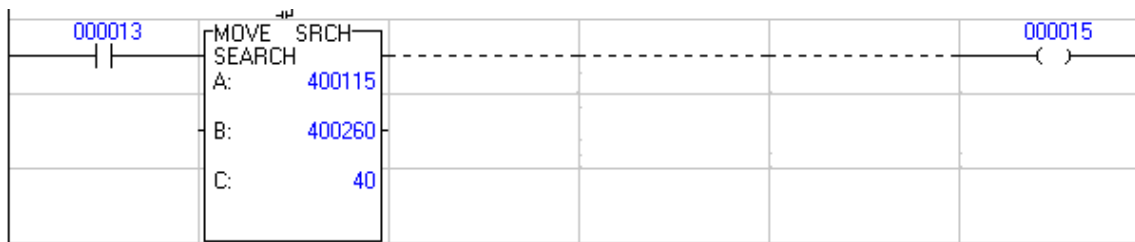

FIFO Move Operations

First-in (FIN)

Ladder Representation

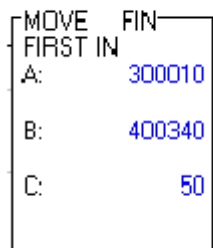

Description

The First-In (FIN) function inserts new data into the queue. The First-In function copies data, a register value or group of 16 discretes, into the queue table.

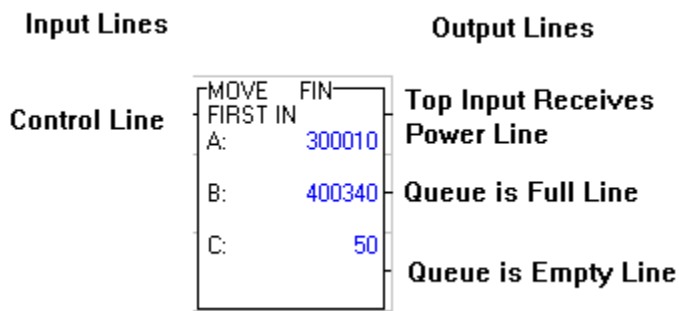

INPUT LINE

Control Line The top input controls the operation. When it receives power, the information in the source register is copied into the first location in the queue and the pointer value is increased.

OUTPUT LINES

Top Input Receives Power Decode Line The top output copies the current state of the top input.

Queue Is Full Decode Line The middle output passes power when the queue is full: pointer value equals queue length.

Queue Is Empty The bottom output passes power when the queue is empty, pointer

Decode Line value equals zero.

**FUNCTION
BLOCK**

Top Node The top node is the source node. It can be one of the following references: a 0XXXX logic coil, a 1XXXX discrete input, a 3XXXX input register, or a 4XXXX holding register. The source is a single 16-bit location (e.g., a register or a group of 16 discretes).

Middle Node The middle node is the destination node. The 4XXXX holding register specified in the node holds the pointer value. The data is placed in the destination table queue starting at 4XXXX+1.

Bottom Node The bottom node contains the numerical value that specifies the queue length. This constant can range from 1 to 100.

NOTE: If the pointer register is loaded with a value greater than the queue length, the controller sets the pointer value to the queue length when the function block is solved.

First-Out (FOUT)

Ladder Representation

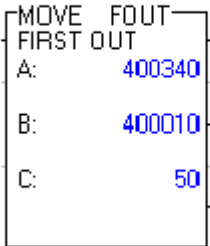

Description

The First-Out function removes the oldest data, a register value or group of discrettes, from the queue table.

Input Lines

Output Lines

Control Line

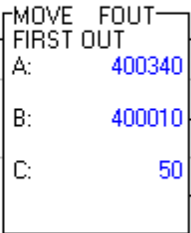

Top Input Receives Power Line

Queue is Full Line

Queue is Empty Line

NOTE: The FOUT function is the only function that uses the source node to specify the pointer register. If the pointer register is loaded with a value greater than the queue length, the controller sets the pointer value to the queue length when the function block is solved.

Logical Data Transfer Functions

Logical AND Function

Description

The Logical AND function takes the result of a mathematical operation (AND) on two matrices and places the result in the second matrix. The value 0 or 1 of each bit in the result is determined by the values in the two matrices. A resulting bit is a one bit (ON) if both bits, are one bits. If either bit or both bits are zeros, the resulting bit is a zero bit (OFF).

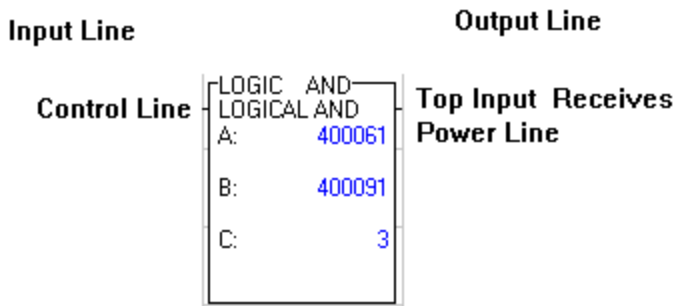

INPUT LINE

Control Line The top input controls the operation. When it receives power, the Logical AND function is performed.

OUTPUT LINE

Top Input Receives Power Decode Line The top output copies the current state of the top input.

FUNCTION BLOCK

Top Node The top node is the source node. It can be one of the following references: a 0XXXX logic coil, a 1XXXX discrete input, a 3XXXX input register, or a 4XXXX holding register. The source matrix is a group of registers or discrettes.

Middle Node The middle node is the second source matrix as well as the destination node. It can be either a 0XXXX logic coil reference or a 4XXXX holding register reference. The destination matrix is the same size as the source.

 Warning	The AND function overrides the disable state of a coil used in the destination node of the function block. This can cause personal injury if the user assumes a coil has disabled an operation and repairs are being made, because the coil's state can change as a result of the AND function.
--	---

Bottom Node The bottom node contains the numerical value that specifies the matrix length for both matrices. This constant can range from 1 to 100. 1 equals a group of 16 bits, 2 equals a group of 32 bits, and so on.

Function Illustration

The following programming example illustrates a network with a Logical AND function.

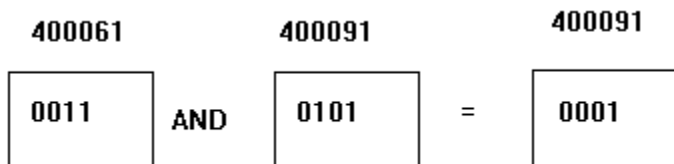

Programming Example

When input 10021 is energized, the top input receives power. A Logical AND operation is performed on the bit pattern in registers 40061-40063 and registers 40091-40093. The resulting bit pattern is placed in registers 40091-40093, thereby replacing the previous bit pattern. The source registers (40061-40063) are not altered.

In applications in which the original information in registers 40091-40093 cannot be lost, the information must be copied into another table before the AND operation takes place. One way to do this is to use a Block Move function. Figure 8.30 illustrates an example Logical AND instruction. If bits 1 through 4 in register 40061 are 0011, and bits 1 through 4 in register 40091 are 0101, the result of a Logical AND operation would be 0001 (placed in register 40091).

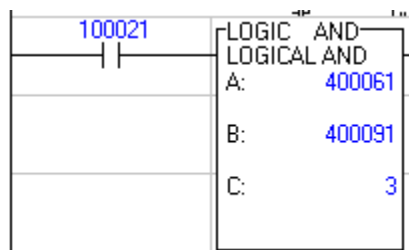

Logical Inclusive OR Function

Description

The Logical Inclusive OR function (or simply the Logical OR function) takes the result of a mathematical operation (OR) on two matrices and places the result in the second matrix. The value 0 or 1 of each bit in the result is determined by the values in the two matrices. A resulting bit is a one bit (ON) if either bit or both bits, from each matrix, are one bits; if both bits are zeros, the resulting bit is a zero bit (OFF).

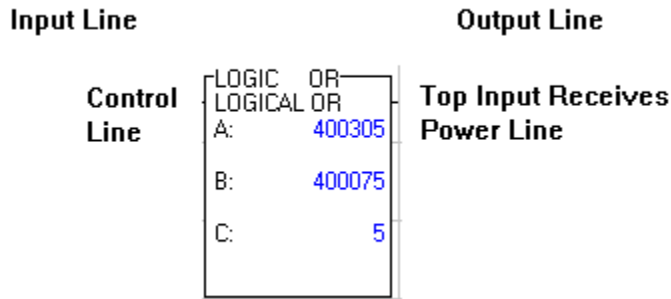

INPUT LINE

Control Line The top input controls the operation. When it receives power, the Logical AND function is performed.

OUTPUT LINE

Top Input Receives Power Decode Line The top output copies the current state of the top input.

FUNCTION BLOCK

Top Node The top node is the source node. It can be one of the following references: a 0XXXX logic coil, a 1XXXX discrete input, a 3XXXX input register, or a 4XXXX holding register. The source matrix is a group of registers or discrettes.

Middle Node The middle node is the second source matrix as well as the destination node. It can be either a 0XXXX logic coil reference or a 4XXXX holding register reference. The destination matrix is the same size as the source.

 <h2 style="margin: 0;">Warning</h2>	<p>The OR function overrides the disable state of a coil used in the destination node of the function block. This can cause personal injury if the user assumes a coil has disabled an operation and repairs are being made, because the coil's state can change as a result of the OR function.</p>
---	--

Bottom Node The bottom node contains the numerical value that specifies the matrix length in registers or groups of discrettes for both matrices. This constant can range from 1 to 100. 1 equals a group of 16 bits, 2 equals a group of 32 bits, and so on.

OR Function Illustration

Figure 11.18 illustrates an example OR instruction. If bits 1 through 4 in register 40305 are 0011, and bits 1 through 4 in register 40075 are 0101, the result of a Logical OR operation (placed in register 40075) is 0111.

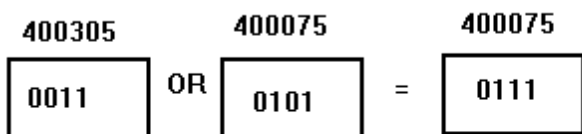

Programming Example

The following programming example illustrates a network with a Logical OR function.

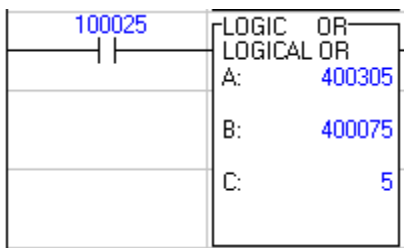

When input 10025 is energized, a Logical OR operation is performed on the bit pattern in registers 40305-40309 and registers 40075-40079. The resulting bit pattern is placed in registers 40075-40079, thereby replacing the previous bit pattern. The source registers (40305-40309) are not altered.

In applications in which the original information in registers 40075-40079 cannot be lost, the information must be copied into another table before the OR operation takes place. One way to do this is to use a Block Move function.

Logical Exclusive OR Function

Description

The Logical Exclusive OR (XOR) function takes the result of a mathematical operation on two matrices and places the result in the second matrix. The value 0 or 1 of each bit in the result is determined by the values in the two matrices.

A resulting bit is a one bit (ON) if either bit, one from each matrix, is a one bit; if they are both zero bits (OFF) or both one bits (ON), the resulting bit is a zero bit (OFF).

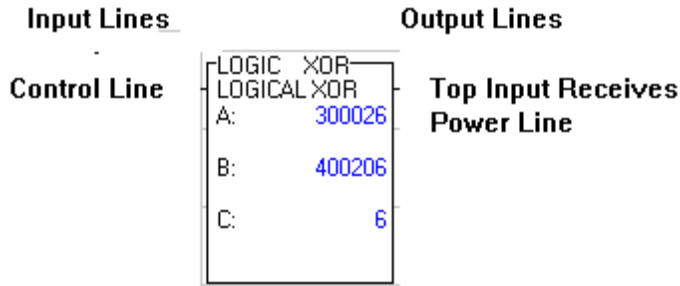

INPUT LINE

Control Line The top input controls the operation. When it receives power, the Logical Exclusive XOR function is performed.

OUTPUT LINE

Top Input Receives Power Decode Line The top output copies the current state of the top input.

FUNCTION BLOCK

Top Node The top node is the source node. It can be one of the following references: a 0XXXX logic coil, a 1XXXX discrete input, a 3XXXX input register, or a 4XXXX holding register. The source matrix is a group of registers or discretes.

Middle Node The middle node is the second source matrix as well as the destination node. It can be either a 0XXXX logic coil reference or a 4XXXX holding register reference. The destination matrix is the same size as the source.



Warning

The XOR function overrides the disable state of a coil used in the destination node of the function block. This can cause personal injury if the user assumes a coil has disabled an operation and repairs are being made, because the coil's state can change as a result of the XOR function.

Bottom Node The bottom node contains the numerical value that specifies the matrix length for both matrices. This constant can range from 1 to 100. 1 equals a group of 16 bits, 2 equals a group of 32 bits, and so on.

Example XOR Instruction

Figure 11.20 shows an XOR instruction. If bits 1 - 4 in register 30026 are 0011, and bits 1 - 4 in 40206 are 0101, the result placed in register 40206 is 0110.

30026		40206		40206
0011	XOR	0101	=	0110

Programming Example

This example illustrates a network with a Logical XOR function.

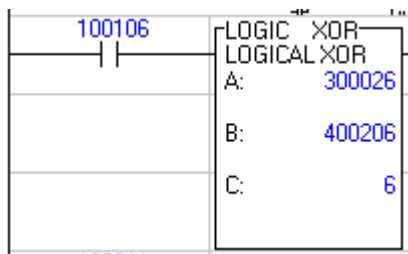

When input 10106 is energized, the top input receives power. A Logical Exclusive OR is performed between the bit patterns in registers 30026-30031 and 40206-40211. The resulting bit pattern is placed in registers 40206-40211, thereby replacing the previous bit pattern. The source registers (30026-30031) are not altered.

In applications in which the original information in registers 40206-40211 cannot be lost, the information must be copied into another table before the XOR takes place. One way to do this is to use the Block Move function.

Logical Complement (COMP)

Description

The Logical Complement function (COMP) causes the contents of a matrix to be Complemented. When a matrix is Complemented, all the ones are replaced with zeros, and all the zeros are replaced with ones. The result is placed in another matrix.

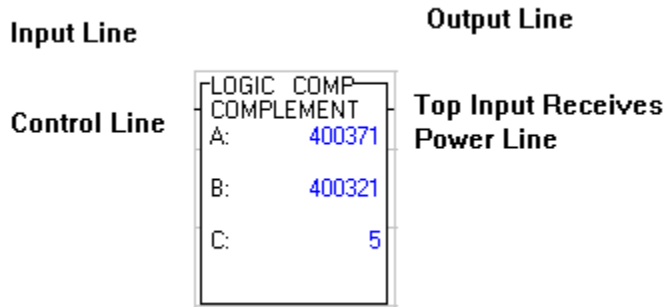

INPUT LINE

Control Line The top input controls the operation. When it receives power, the Logical COMP function is performed.

OUTPUT LINE

Top Input Receives Power Decode Line The top output copies the current state of the top input.

FUNCTION BLOCK

Top Node The top node is the source node. It can be one of the following references: a 0XXXX logic coil, a 1XXXX discrete input, a 3XXXX input register, or a 4XXXX holding register. The source matrix is a group of registers or discrettes.

Middle Node The middle node is the destination node. It can be either a 0XXXX logic coil reference or a 4XXXX holding register reference. The destination matrix is the same size as the source.

 Warning	<p>The Logical Complement function overrides the disable state of a coil used in the destination node of the function block. This can cause personal injury if the user assumes a coil has disabled an operation and repairs are being made, because the coil's state can change as a result of the Logical Complement function.</p>
--	--

Bottom Node The bottom node contains the numerical value that specifies the matrix length for both matrices. This constant can range from 1 to 100. 1 equals a group of 16 bits, 2 equals a group of 32 bits, and so on.

Example Instruction

Figure 11.22 illustrates an example Logical Complement instruction. If bits 1 through 4 in register 40371 are 0011, the Logical Complement, placed in register 40321, is 1100.

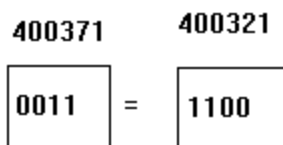

Programming Example

This programming example illustrates a network with a Logical Complement function.

When input 10011 is energized, the bit pattern in registers 40371-40375 is complemented. The resulting bit pattern is placed in registers 40321-40325. The source registers (40371-40375) are not altered.

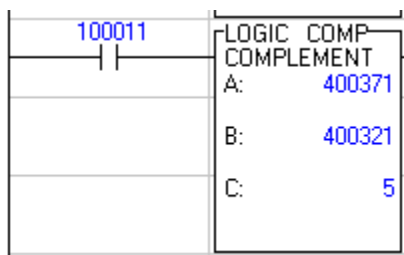

SAVE Instruction Block

Description

The SAVE block saves a block of 4x registers to state RAM where they are protected from unauthorized modification.

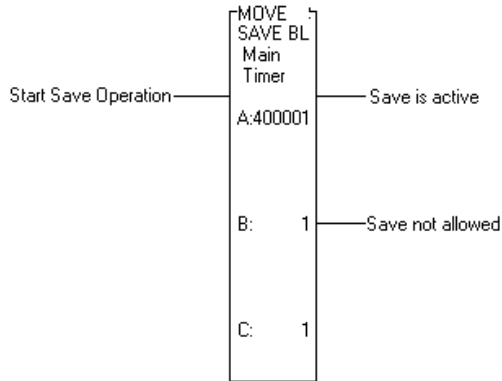

INPUT LINE SAVE has one control input that starts the operation and it should remain ON until the operation has completed successfully or an error has occurred.

OUTPUT LINE SAVE may produce two possible outputs. The outputs from the top node go ON while a SAVE operation is in progress. The output from the middle node goes ON when previously SAVED data has not been accessed using the LOAD instruction. This prevents inadvertent overwriting of data in the SAVE buffer.

Top Node The top node specifies a block of 4x registers to be saved to state RAM. The 4x register entered here defines the beginning register of the block.

Middle Node The middle node defines the specific buffer, within state RAM, where the block of data is to be SAVED. Four 512-word buffers are allowed. Each buffer is defined by placing its corresponding value in the middle node, that is, the value 1 represents the first buffer, value 2 represents the second buffer and so on. The legal values are 1, 2, 3, and 4. When the PLC is started all four buffers are zeroed. Therefore, you may not SAVE data to the same buffer without first LOADING it. When this is attempted the middle output goes ON. In other words, once a buffer is used, it may not be used again until the data has been removed

Bottom Node The bottom node contains the number of words to be SAVED. The range is 1 ... 512.

LOAD Instruction Block

Description

The LOAD block loads a block of 4x registers (previously SAVED) from state RAM where they are protected from unauthorized modification.

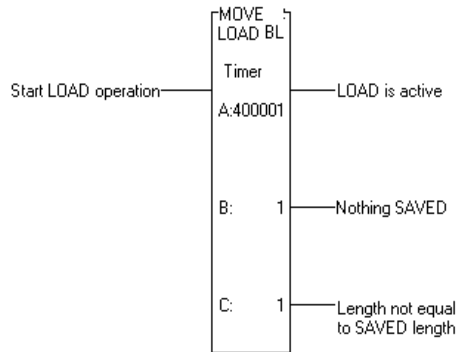

INPUT LINE

LOAD has one control input that starts the operation and it should remain ON until the operation has completed successfully or an error has occurred.

OUTPUT LINE

LOAD may produce three possible outputs. The outputs from the top node go ON while a LOAD operation is in progress. The output from the middle node goes ON when a LOAD is requested from a buffer where no data has been SAVED. Therefore, no LOAD is allowed. This prevents inadvertent overwriting of data in state RAM. The output from the bottom node goes ON when a LOAD request is not equal to the registers that were SAVED. This kind of transaction is allowed, however, it is your responsibility to ensure this does not create a problem in your application.

Top Node

The top node specifies a block of 4x registers to be loaded from state RAM. The 4x register entered here defines the beginning register of the block.

Middle Node

The middle node defines the specific buffer where the block of data is to be LOADED. Four 512-word buffers are allowed. Each buffer is defined by placing its corresponding value in the middle node, that is, the value 1 represents the first buffer, value 2 represents the second buffer and so on. The legal values are 1, 2, 3, and 4. When the PLC is started all four buffers are zeroed. Therefore, you may not LOAD data from the same buffer without first SAVEing it. When this is attempted the middle output goes ON. In other words, once a buffer is used, it may not be used again until the data has been removed.

Bottom Node

The bottom node contains the number of words to be LOADED. The range is 1 ... 512.

14 - Logic Bit Instructions

General Description

The Logical DX functions use bit patterns, and can revise data, shift data, or examine data in a matrix with or without altering the source.

Each Logical DX function block occupies three nodes in a ten by seven node network format, and consists of a source node, a destination node, and a node specifying matrix length in registers.

The top input is the control input; when it receives power the function is performed. The top output passes power when the top input receives power. This allows function blocks to be cascaded within a network.

The four types of Logical Bit operations - Logical Compare, Logical Bit Modify, Logical Bit Sense and Logical Bit Rotate - are explained in this chapter.

Logical Compare (CMPR)

Description

The Logical Compare (CMPR) function compares two matrices bit-by-bit. The contents of the matrices are only examined, not altered. If two bits agree (both zeros or both ones) then the next two bits are compared. If the two bits do not agree, the function stops and the pointer contains the position of the bit that did not agree.

The result of the function, Mismatch or agreement, is indicated by the middle output. If no mismatch is found, the function stops at the end of the table being compared.

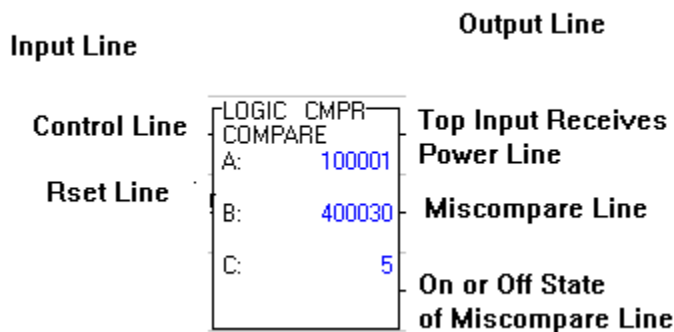

INPUT LINES

Control Line

The top input controls the operation. When it receives power, two matrices are compared bit-by-bit.

Reset Line

The middle input, when receiving power, resets the pointer value to zero.

NOTE: The position of the matrix bit being compared at any one time is equal to the pointer value plus one. If the pointer value is greater than or equal to the matrix length, the controller resets the pointer value to zero before performing the function.

OUTPUT LINES

**Top Input
Receives Power
Decode Line**

The top output copies the current state of the top input.

**Miscompare
Decode Line**

The middle output passes power if a miscompare is found. This output does not pass power when: the top input is not receiving power, no miscompare is found, or the end of the matrix is reached.

**ON or OFF State
of Miscompare
Decode Line**

The bottom output is controlled by the middle output. If a miscompare is found, the bottom output indicates the ON or OFF state of the bit in the first matrix. If the bit is a one, this output passes power. The output does not pass power if the bit is a zero.

FUNCTION BLOCK

Top Node

The top node is the source node. It can be one of the following references: a 0XXXX logic coil, a 1XXXX discrete input, a 3XXXX input register, or a 4XXXX holding register. The source matrix is a group of registers or discretets.

Middle Node

The middle node is the destination node. It is a 4XXXX holding register reference. The register holds the pointer value that controls which bit the compare starts at, and when the compare is done, it indicates which bit is a miscompare. The matrix is located in consecutive registers immediately following the pointer, starting at 4XXXX+1.

Bottom Node

The bottom node contains the numerical value that specifies the matrix length in registers or groups of discretets for both matrices. This constant can range from 1 to 100. 1 bit equals a group of 12 bits, 2 equals a group of 2 bits, and so on.

Programming Example

The following example illustrates a network with a Logical CMPR function.

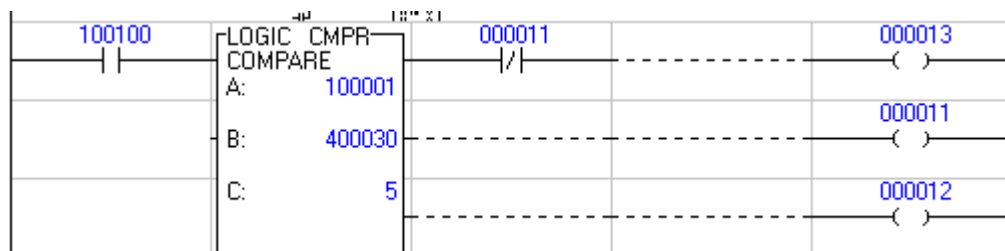

When input 10100 is energized, the top input receives power. Discrete inputs 10001-10005 are compared bit-by-bit with registers 40031-40035. The registers and discretives are not altered. If two bits, one from each matrix, do not agree, the function stops and coil 00011 is energized. Coil 00012 indicates the status of the miscompare bit in the first matrix.

If a bit in 10001 is a one bit and it is compared with a zero bit in register 40031, the bottom output passes power and energizes coil 00012. If discrete 10001 contains a zero bit that is compared to a one bit in register 40031, the bottom output does not pass power and coil 00012 is not energized. In both cases, the location of the bit that miscompared is placed in register 40030 and the Compare function continues from that point.

If a normal relay contact is used, the Compare function continues after finding a miscompare so the pointer value changes. If the location of the miscompare is bit 5, the compare continues at bit 6.

To detect the end of the table if no miscompare has been found, a vertical branch and a normally closed contact referenced to coil 00011 are placed beside the top output of the function block. If no miscompare is found, coil 00011 remains OFF and therefore normally closed contact 00011 passes power and energizes coil 00013, no miscompare and end of table.

Logical Bit Modify (MBIT)

Description

The Logical Bit Modify (MBIT) function alters the state of individual bits in a matrix. Only one bit can be altered per scan; it can be set to one or cleared to zero.

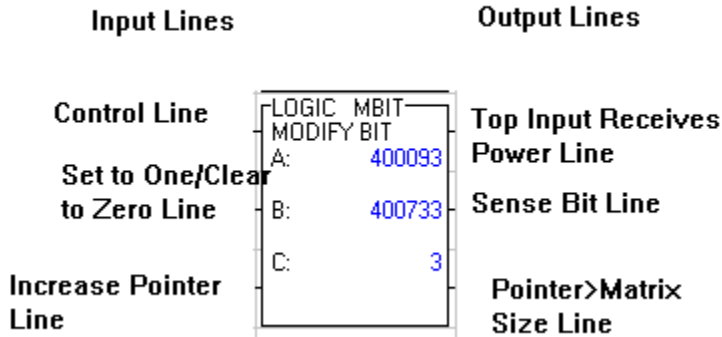

INPUT LINES

Control Line The top input controls the operation. When it receives power, the bit specified in the pointer register is either set to one or cleared to zero.

Set to One/Clear to Zero Line The middle input controls whether the specified bit is set to one or cleared to zero. If this input receives power, the bit is set to one. If no power is received, the bit is cleared to zero.

Increase Pointer Line The bottom input, when receiving power with the top input, increases the pointer value. This is possible only if a 4XXXX reference is in the top node.

NOTE: If the pointer value is increased beyond the matrix size, the controller resets the pointer value to one before performing the function. If a pointer value is inserted which is greater than the matrix size, the pointer value is not reset, the function is not performed, and the bottom output passes power.

OUTPUT LINES

Top Input Receives Power Decode Line The top output copies the current state of the top input.

Sense Bit Decode The middle output passes power when the bit being modified is set to

Line one. It passes power when the middle input receives power.

Pointer>Matrix Size Decode Line The bottom output passes power if the pointer value is greater than the matrix size. In this case, no operation is performed and the pointer value is set to the matrix size.

FUNCTION BLOCK

Top Node The top node is the pointer that controls which bit is modified. It can be a 3XXXX input register reference, a 4XXXX holding register reference, or a constant (up to 999 for a 16-bit processor and 9999 for a 24-bit processor). If a holding register is used, the pointer value can be increased by control of the bottom input.

Middle Node The middle node is the source and destination node; the revised data replaces the original data in the matrix. It can be either a 0XXXX logic coil reference or a 4XXXX holding register reference. If a logic coil is used, it can only be used once in this function block. The logic coil cannot be used in another function block or in the eleventh column of a network; it can be used as a relay contact.



Warning

The MBIT function overrides the disable state of a coil used in the destination node of the function block. This can cause personal injury if the user assumes a coil has disabled an operation and repairs are being made, because the coil's state can change as a result of the MBIT function.

Bottom Node The bottom node contains the numerical value that specifies the matrix length. This constant can range from 1 to 255 registers or groups of discretes (16 to 4080 bits).

Programming Example

The following example illustrates a network with a Logical MBIT function.

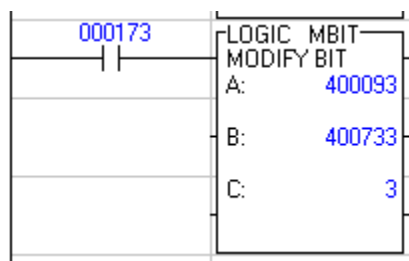

When input 00173 is energized, the bit in matrix 40733-40735 at the location indicated by the pointer value (register 40093), is set to one, regardless of what it was before. To clear the bit to zero, remove the vertical connection between the top and middle inputs.

Logical Bit Sense (SENS)

Description

The Logical Bit Sense (SENS) function examines and reports the state of individual bits in a matrix. One bit is examined per scan.

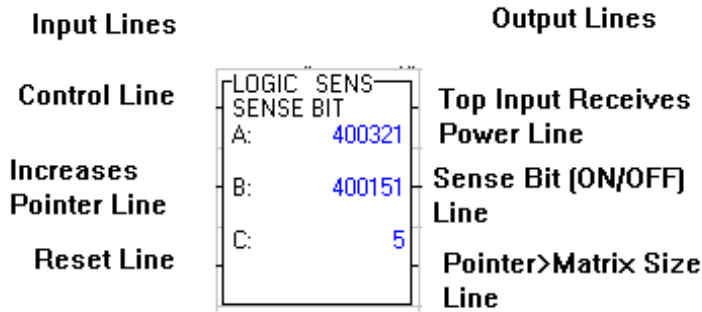

INPUT LINES

- Control Line** The top input controls the operation. When it receives power, one bit in a matrix is examined and its status is reported.
- Increases Pointer Line** The middle input, when receiving power with the top input, increases the pointer value. This is possible only if a 4XXXX reference is in the top node.

NOTE: If the pointer value is increased beyond the matrix size, the controller resets the pointer value to one before performing the function. If a pointer value is inserted which is greater than the matrix size, the pointer value is not reset, the function is not performed, and the bottom output passes power.

- Reset Line** The bottom input, when receiving power, resets the pointer value to one. This is only possible if the pointer is a 4XXXX reference.

OUTPUT LINES

- Top Input Receives Power Decode Line** The top output copies the current state of the top input.
- Sense Bit Decode Line** The middle output passes power when the bit being examined is a one bit. This output does not pass power when the bit is a zero bit.
- Pointer>Matrix Size Decode Line** The bottom output passes power if the pointer value is greater than the matrix size. In this case, no operation is performed.

FUNCTION BLOCK

- Top Node** The top node holds the pointer value that controls which bit is examined. It can be a 3XXXX input register reference, a 4XXXX holding register reference, or a constant (up to 999 for a 16-bit processor or 9999 for a 24-bit processor). If the reference is a 4XXXX holding register, the pointer value can be increased by control of the middle input.
- Middle Node** The middle node is the source node. It can be one of the following references: a 0XXXX logic coil, a 1XXXX discrete input, a 3XXXX input register, or a 4XXXX holding register. The source matrix is a group of registers or discretives.
- Bottom Node** The bottom node contains the numerical value that specifies the matrix length. This constant can range from 1 to 255 registers or groups of discretives (16 to 4080 bits).

Programming Example

The following example illustrates a network with a Logical SENS function.

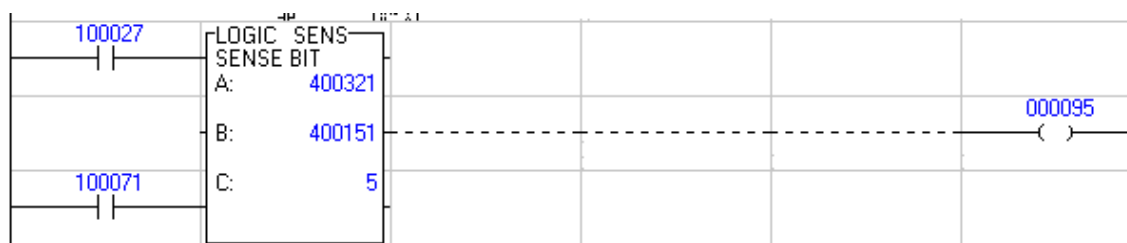

When input 10027 is energized, the top and middle inputs receive power, and the bit in matrix 40151-40155 at the location indicated by the pointer value (register 40321), is examined. Only one bit is examined per scan.

If the bit is a one bit, the middle output passes power and energizes coil 00095. If the bit is a zero bit, no power is passed. Since the middle input receives power by way of the vertical connection between the top and middle inputs, the pointer increases by one during each scan that input 10027 is energized.

To reset the pointer, input 10071 must be energized, a transitional contact is used to ensure that the pointer is reset only once, no matter how many scans input 10071 remains energized.

Logical Bit Rotate (BROT)

Description

The Logical Bit Rotate (BROT) function shifts or rotates bits in a matrix. The bits can be rotated to the left or to the right, and if bits are removed beyond the boundaries of the matrix, they can be wrapped around to the vacated bits at the start of the matrix. If the bits shifted out of the matrix are not wrapped around, the vacated bits are filled with zeros.

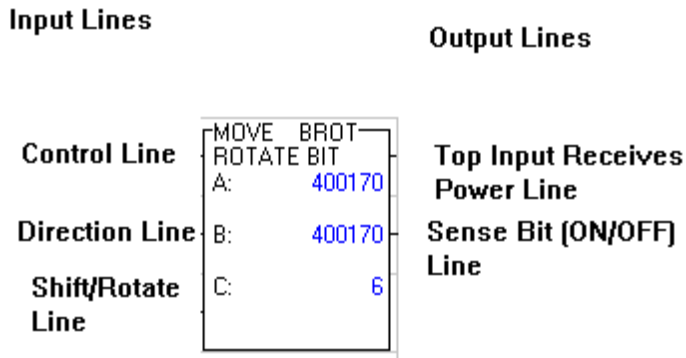

INPUT LINES

Control Line

The top input controls the operation. When it receives power, all the bits in a matrix are rotated or shifted one position per scan.

Direction Line

The middle input controls the direction of the shift. Bits can be shifted either toward the right or toward the left. If this input receives power, the bits are shifted toward the left (i.e., bit 17 into 16, bit 16 into 15, ... bit 3 into 2, bit 2 into 1, bit 1 out of the matrix). If this input does not receive power, the bits are shifted toward the right (i.e., bit 1 into 2, bit 2 into 3, ... bit 15 into 16, bit 16 into 17, etc.). The last bit is shifted out of the matrix.

Shift/Rotate Line

The bottom input controls the wrap-around of the bits. If it receives power, the bits shifted out of the matrix are carried around unchanged and entered into the opposite end of the matrix, i.e., wrapped around. If this input does not receive power, the bits shifted out of the matrix are discarded. The vacant bit positions at the opposite end of the matrix are filled with zeros.

OUTPUT LINES

Top Input Receives Power

The top output copies the current state of the top input.

Decode Line

Sense Bit Decode Line The middle output passes power when the bit being shifted out of the matrix is a one bit, regardless of whether the bit is being wrapped around or discarded.

FUNCTION BLOCK

Top Node The top node is the source node. It can be one of the following references: a 0XXXX logic coil, a 1XXXX discrete input, a 3XXXX input register, or a 4XXXX holding register. The source matrix is a group of registers or discretets. Its contents or status is not altered.

Middle Node The middle node is the destination node. It can be either a 0XXXX logic coil reference or a 4XXXX holding register reference. The destination matrix is the same size as the source. If a logic coil is used it cannot be used in another function block or in the eleventh column of a network; it can be used as a relay contact.

 Warning	<p>The BROT function overrides the disable state of a coil used in the destination node of the function block. This can cause personal injury if the user assumes a coil has disabled an operation and repairs are being made, because the coil's state can change as a result of the BROT function.</p>
--	--

Bottom Node The bottom node contains the numerical value that specifies the matrix length for both matrices. This constant can range from 1 to 100 registers or groups of discretets (16 to 1600 bits).

Programming Example

The following example illustrates a network with a Logical BROT function.

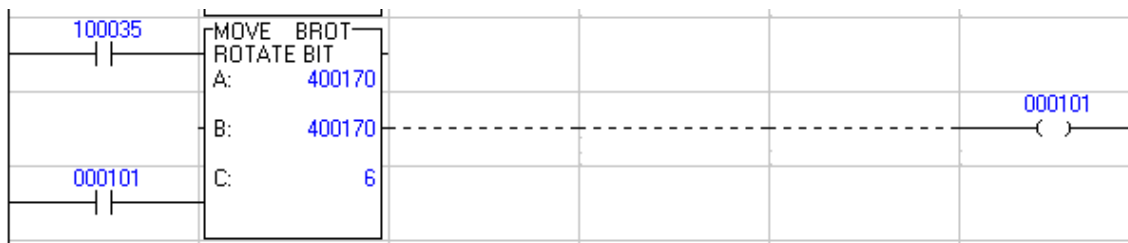

When input 10035 is energized, the top input receives power and all the bits in matrix 40170-40175 are shifted one position to the right. The last bit, bit 96, is shifted out of the matrix.

If this bit is a one bit (ON), the middle output passes power and energizes coil 00101. Since the bottom input is not receiving power, bit 1 is filled with a zero. If the bottom input had been receiving power, the bit shifted out of the matrix would have been wrapped around into the first bit position in the matrix.

15 - Status Instructions

Monitoring System Status

General Description

This chapter describes the use of the STAT function for monitoring system status.

Get Controller System Status (STAT)

Description

The Get Controller System Status (STAT) function obtains vital information about the controller (such as memory protect status, battery status, I/O error, loss of active lights and J200 Remote I/O Interface status). The information is placed in a table of registers or discrettes.

Input Lines

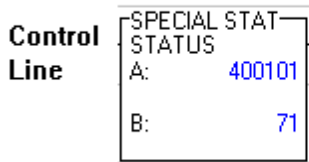

Output Lines

Top Input Receives Power Line

S901 - Status

The S901 Status Table

Status information is located in specific words of memory. Each word has its own holding register or group of 16 discrete outputs. The status information available and the words containing the information are shown in the table below. The 75 words in the S901 status table are divided into three sections - the first 11 words for controller status information, the next 32 words for I/O module health information, and the last 32 words for I/O communications information:

Decimal Word		Hex Word
1	Controller Status	01
2	Not Used	02
3	Controller Status	03
4	S901 Status	04
5	Controller Stop State	05
6	Number of Segments in User Logic	06
7	Address of End-of-logic Pointer	07
8	RIO Redundancy and Timeout	08

9	ASCII Message Status	09
10	Run Load Debug Status	0A
11	Address of Status Word Pointer Table	0B
12	Channel 1 Input Channel 2 Input	0C
13	Channel 3 Input Channel 4 Input	0D
14	Channel 5 Input Channel 6 Input	0E
	“ “ “ “ “ “ “ “ ””””””””””	“ ”
27	Channel 29 Input Channel 30 Input	1B
28	Channel 31 Input Channel 32 Input	1C
29	Channel 1 Output Channel 2 Output	1D
30	Channel 3 Output Channel 4 Output	1E
31	Channel 5 Output Channel 6 Output	1F
	“ “ “ “ “ “ “ “	“
42	Channel 29 Output Channel 30 Output	2A
43	Channel 31 Output Channel 32 Output	2B
44	Remote I/O Channels 5 and 6 First Word	2C
45	Remote I/O Channels 5 and 6 Second Word	2D
46	Remote I/O Channels 7 and 8 First Word	2E
47	Remote I/O Channels 7 and 8 Second Word	2F
	“ “ “ “	“
70	Remote I/O Channels 31 and 32 First Word	46
71	Remote I/O Channels 31 and 32 Second Word	47

72	Remote I/O Channels 1 and 2 First Word	48
73	Remote I/O Channels 1 and 2 Second Word	49
74	Remote I/O Channels 3 and 4 First Word	4A
75	Remote I/O Channels 3 and 4 Second Word	4B

S901 Controller Status Words

Words 1 through 11 display the controller status words. Bits in a word are numbered 1 to 16 and progress from left to right. Bit 1 is the most significant bit (MSB). Bit 16 is the least significant bit (LSB).

NOTE: The STAT block puts status words for remote channels 1-4 after the status words for channel 32, instead of before the status words for channel 5.

Word 1

Displays the following aspects of the controller's status:

If the bit is set to 1, then the condition is TRUE.

Bit No.	Condition
1	Not Used
2	Not Used
3	Not Used
4	Not Used
5	Not Used
6	Enable Constant Sweep
7	Enable Single Sweep Delay
8	1 = 16-Bit User Logic 2 = 24-Bit User Logic
9	AC Power ON
10	Run Light OFF
11	Memory Protect is OFF
12	Battery Failed
13	Not Used
14	Not Used
15	Not Used
16	Not Used

Word 2

Word 2 is not used; all bit values are 0.

Word 3

Displays the following aspects of the controller's status:

If the bit is set to 1, then the condition is TRUE.

Bit No.	Condition
1	First Scan
2	Start Command Pending
3	Constant Sweep Times Exceeded
4	Exiting DIM AWARENESS
5	Not Used
6	Not Used
7	Not Used
8	Not Used
9	Not Used
10	Not Used
11	Not Used
12	Not Used
13	Single Sweeps
14	Single Sweeps
15	Single Sweeps
16	Single Sweeps

Word 4

Displays the status of the S901 Remote I/O Processor:

If the bit is set to 1, then the condition is TRUE.

Bit No.	Condition
1	S901 Bad
2	S901 Timeout
3	S901 Loopback Failure
4	S901 Memory Failure
5	Not Used
6	Not Used
7	Not Used
8	Not Used
9	Not Used
10	Not Used
11	Not Used
12	Not Used
13	Not Used
14	RIO Error*
15	RIO Error*
16	RIO Error*

* RIO Errors

000 = RIO did not respond

001 = No response on loopback

010 = Failed loopback data check

011 = Timeout while awaiting a response

100 = RIO did not accept message

Word 5

Displays the controller's stop state conditions:

If the bit is set to 1, then the condition is TRUE.

Bit No.	Condition
1	Peripheral Port Stop
2	Extended Memory Parity Error
3	Controller in DIM AWARENESS
4	Illegal Peripheral Intervention
5	Segment Scheduler Invalid
6	Start of Node Did Not Start Segment
7	State RAM Test Failed
8	No End-of-Logic
9	Watchdog Timer Expired
10	Real Time Clock Error
11	CPU Failed
12	Invalid Traffic Cop
13	Invalid Node
14	Logic Checksum
15	Coil Disabled in RUN Mode
16	Bad Config

Word 6

Displays the number of logic segments:

Bit No.	Condition
1 - 16	Number of Segments (expressed as a binary number)

Word 7

Displays the end-of-logic (EOL) pointer:

Bit No.	Condition
1 - 16	EOL Pointer

Word 8

Holds a RIO redundancy flag and displays an RIO timeout constant:

Bit No.	Condition
1	RIO Redundancy Flag
2	Not Used
3	Not Used
4	Not Used
5	Not Used
6	Not Used
7	Not Used
8	Not Used
9	Not Used
10	Not Used
11	Not Used
12	Not Used
13	RIO Timeout Constant
14	RIO Timeout Constant
15	RIO Timeout Constant
16	RIO Timeout Constant

Word 9

Displays the ASCII message status:

If the bit is set to 1, then the condition is TRUE.

Bit No.	Condition
1	Not Used
2	Not Used
3	Not Used
4	Not Used
5	Not Used
6	Not Used
7	Not Used
8	Not Used
9	Not Used
10	Not Used
11	Not Used
12	Not Used
13	Mismatch Between Number of Messages and Pointers
14	Invalid Message Pointer
15	Invalid Message
16	Message Checksum Error

Word 10

Uses its two most significant bits to display the RUN load debug status:

If the bit is set to 1, then the condition is TRUE.

Bit No.	Condition
1	Not Used
2	Not Used
3	Not Used
4	Not Used
5	Not Used
6	Not Used
7	Not Used
8	Not Used
9	Not Used
10	Not Used
11	Not Used
12	Not Used
13	Not Used
14	Not Used
15	Debug = 0, Run = 0, Load = 1
16	Debug = 0, Run = 1, Load = 0

Word 11

Displays the address of the table of status word pointers:

Bit No.	Condition
1 - 16	Pointer to the Table of Status Word Pointers

S901 I/O Module Health Status Words

Words 12 through 43 display the health of the I/O modules in the odd and even channels:

Decimal Word		Hex Word
12	Channel 1 Input Channel 2 Input	0C
13	Channel 3 Input Channel 4 Input	0D
14	Channel 5 Input Channel 6 Input	0E
	“ “ “ “ “ “ “ “ “ “	“
26	Channel 29 Input Channel 30 Input	1B
27	Channel 31 Input Channel 32 Input	1C
28	Channel 1 Output Channel 2 Output	1D
29	Channel 3 Output Channel 4 Output	1E
30	Channel 5 Output Channel 6 Output	1F
	“ “ “ “ “ “ “ “ “ “	“
42	Channel 29 Output Channel 30 Output	2A
43	Channel 31 Output Channel 32 Output	2B

Each of these 32 status words is organized as follows:

Odd Channels

Bit No.	Slot No.
1	I/O Slot No. 1
2	I/O Slot No. 2
3	I/O Slot No. 3
4	I/O Slot No. 4
5	I/O Slot No. 5
6	I/O Slot No. 6
7	I/O Slot No. 7
8	I/O Slot No. 8

Even Channels

Bit No.	Slot No.
9	I/O Slot No. 1
10	I/O Slot No. 2
11	I/O Slot No. 3
12	I/O Slot No. 4
13	I/O Slot No. 5
14	I/O Slot No. 6
15	I/O Slot No. 7
16	I/O Slot No. 8

If a specified slot is inhibited in the Traffic Cop, the bit is 0. If the slot contains an input module or an input/output module, the bit is set to 1. If the slot contains an output module and the module's COMM active LED is ON, the bit is 0. If the slot contains an output module and the module's COMM ACTIVE LED is OFF, the bit is 1.

NOTE: These indicators are valid only when scan time > 30 ms.

S901 RIO Communication Status Words

Words 44-75 represent the communication status to J200 drops. Two words are used to describe each of up to 16 drops.

Word 1

Bit No.	Condition
1-3	This field identifies the type of processing scheduled to be performed by the processor for the addressed IOR. The following functions are defined: 000 - Normal I/O 001 - Restart Phase I (Communication Reset) 010 - Restart Phase II (Application Reset) 011 - Unassigned 100 - INHIBIT 101 - Unassigned 110 - Unassigned 111 - Unassigned
4	Sequence Number Invalid
5	Byte Count Underrun
6	Current Message not Supported
7	Not Used
8	Busy 0.
9-11	Receive Sequence Number
12	Cable B.
13-15	Send Sequence Number
16	Busy 1.

Word 2

If the bit is set to 1, then the condition is TRUE.

Bit No.	Condition
1	Not Used
2	Character Overrun From the Addressed Drop
3	CRC Error From Addressed Drop
4	Addressed Drop did not Respond
5	Not Used
6	Drop Just Powered Up
7	Invalid Sequence Number
8	Command Not Supported by Drop
9-16	Retry Counter Drop attempted by the processor to the addressed IOR. The maximum value is 25510.

S908 Status

The S908 Status Table

The 277 words in the S908 status table are organized in three sections - the first 11 words for controller status, the next 160 words for I/O module health, and the last 106 words for I/O communication health:

Decimal Word		Hex Word
1	Controller Status	01
2	Hot Standby Status	02
3	Controller Status	03
4	RIO Status	04
5	Controller Stop State	05
6	Number of Ladder Logic Segments	06
7	Address of End-of-logic Pointer	07
8	RIO Redundancy and Timeout/ Memory Sizing Word for Panel (in the 984-145 Compact Controller)	08
9	ASCII Message Status	09
10	Run/Load/Debug Status	0A
11	Not Used	0B
12	Drop 1, Rack 1	0C
13	Drop 1, Rack 2	0D
14	Drop 1, Rack 3	0E
15	Drop 1, Rack 4	0F
16	Drop 1, Rack 5	10
17	Drop 2, Rack 1	11
18	Drop 2, Rack 2	12
	“ “ “ “	
170	Drop 32, Rack 4	AA
171	Drop 32, Rack 5	AB
172	S908 Startup Error Code	AC
173-175	Cable A Errors	AD- AF
176-178	Cable B Errors	B0-B2
179-181	Global Communication Errors	B3-B5
182-184	Drop 1 Errors/ Health Status and Retry Counters (in the Compact 984 Controllers)	B6-B8

185-187	Drop 2 Errors	B9-BB
188-190	Drop 3 Errors	BC-BE
272-274	Drop 31 Errors	110- 112
275-277	Drop 32 Errors	113- 115

S908 Controller Status Words

Words 1 through 11 display the controller status words.

Word 1

Displays the following aspects of the controller's status:

If the bit is set to 1, then the condition is TRUE.

Bit No.	Condition
1-5	Not Used.
6	Enable Constant Sweep
7	Enable Single Sweep Delay
8	1 = 16-Bit User Logic 2 = 24-Bit User Logic
9	AC Power ON
10	Run Light On
11	Memory Protect is OFF
12	Battery Failed
13-16	Not Used

Word 2

Displays the Hot Standby status for 984 controllers that use S911/R911 Modules:

If the bit is set to 1, then the condition is TRUE.

Bit No.	Condition
1	S911/R911 Present and Healthy
2	Not Used
3	Not Used
4	Not Used
5	Not Used
6	Not Used
7	Not Used
8	Not Used
9	Not Used
10	Not Used
11	0 = Controller Toggle Set to A 1 = Controller Toggle Set to B
12	0 = Controllers have Matching Logic 1 = Controllers not have MatchLogic
13	Remote System State*
14	Remote System State*
15	Local System State*
16	Local System State*

* 00 = Not Used

01 = Off Line

10 = Primary

11 = Standby

Word 3

Displays the following aspects of the controller's status:

If the bit is set to 1, then the condition is TRUE.

Bit No.	Condition
1	First Scan
2	Start Command Pending
3	Constant Sweep Times Exceeded
4	Exiting DIM AWARENESS
5	Not Used
6	Not Used
7	Not Used
8	Not Used
9	Not Used
10	Not Used
11	Not Used
12	Not Used
13	Single Sweeps
14	Single Sweeps
15	Single Sweeps
16	Single Sweeps

Word 4

Displays the status of the 984 controller.

If the bit is set to 1, then the condition is TRUE.

Bit No.	Condition
1	IOP Bad
2	IOP Timeout
3	IOP Loopback Failure
4	IOP Memory Failure
5	Not Used
6	Not Used
7	Not Used
8	Not Used
9	Not Used
10	Not Used
11	Not Used
12	Not Used
13	Not Used
14	I/O Error *
15	I/O Error*
16	I/O Error*

* 000 = I/O did not respond

001 = No response on loopback

010 = Failed loopback data check

011 = Timeout while awaiting a response

100 = I/O did not accept message

Word 5

Displays the controller's stop state conditions:

If the bit is set to 1, then the condition is TRUE.

Bit No.	Condition
1	Peripheral Port Stop
2	Extended Memory Parity Error for chassis mount controllers or Traffic Cop/S908 Errors for other Controllers
3	Controller in DIM AWARENESS
4	Illegal Peripheral Intervention
5	Segment Scheduler Invalid
6	Start of Node Did Not Start Segment
7	State RAM Test Failed
8	Invalid Traffic Cop
9	Watchdog Timer Expired
10	Real Time Clock Error
11	CPU Logic Solver Failed for chassis mount controllers or Coil Used Table for other Controllers
12	IOP Failure
13	Invalid Node
14	Logic Checksum
15	Coil Disabled in RUN Mode
16	Bad Configuration

Word 6

Displays the number of segments in ladder logic; a binary number is shown:

Bit No.	Condition
1 - 16	Number of Segments (expresses as a binary number)

Word 7

Displays the address of the end-of-logic (EOL) pointer:

Bit No.	Condition
1 - 16	ROL Pointer Address

Word 8

In controllers that support remote I/O, word 8 uses its most significant bit to display whether or not redundant coaxial cables are run to the remote I/O drops. It uses at four least significant bits to display the remote I/O timeout constant:

Bit No.	Condition
1	RIO Redundant Cables? 0 = No, 1= Yes
2	Not Used
3	Not Used
4	Not Used
5	Not Used
6	Not Used
7	Not Used
8	Not Used
9	Not Used
10	Not Used
11	Not Used
12	Not Used
13	RIO Timeout Constant
14	RIO Timeout Constant
15	RIO Timeout Constant
16	RIO Timeout Constant

In the Compact 984-145 controller, word 8 is used to store a numerical value that defines the upper limit of memory locations on page 0 where user logic can be placed. This value is not user-configurable and is used only by the programming panel.

Word 9

Displays the ASCII message status:

If the bit is set to 1, then the condition is TRUE.

Bit No.	Condition
1	Not Used
2	Not Used
3	Not Used
4	Not Used
5	Not Used
6	Not Used
7	Not Used
8	Not Used
9	Not Used
10	Not Used
11	Not Used
12	Not Used
13	Mismatch Between Number of Messages and Pointers
14	Invalid Message Pointer
15	Invalid Message
16	Message Checksum Error

Word 10

Displays the RUN/LOAD/DEBUG status:

If the bit is set to 1, then the condition is TRUE.

Bit No.	Condition
1	Not Used
2	Not Used
3	Not Used
4	Not Used
5	Not Used
6	Not Used
7	Not Used
8	Not Used
9	Not Used
10	Not Used
11	Not Used
12	Not Used
13	Not Used
14	Not Used
15	Debug = 0, Run = 0, Load = 1
16	Debug = 0, Run = 1, Load = 0

Word 11

Word 11 is not used.

S908 I/O Module Health Status Words

Words 12 through 171 display the health of the I/O modules:

Decimal Word		Hex Word
12	Drop 1, Rack 1	0C
13	Drop 1, Rack 2	0D
14	Drop 1, Rack 3	0E
15	Drop 1, Rack 4	0F
16	Drop 1, Rack 5	10
17	Drop 2, Rack 1	11
18	Drop 2, Rack 2	12
	“ “ “ “	
170	Drop 32, Rack 4	AA
172	Drop 32, Rack 5	AB

Five words are reserved for each of up to 32 drops, one word for each of up to five possible racks (I/O housings) in each drop. Each rack may contain up to 11 I/O modules; bits 1 through 11 in each word represent the health of the associated I/O module in each rack.

If the bit is set to 1, then the condition is TRUE.

Bit No.	Slot No.
1	I/O Slot No. 1
2	I/O Slot No. 2
3	I/O Slot No. 3
4	I/O Slot No. 4
5	I/O Slot No. 5
6	I/O Slot No. 6
7	I/O Slot No. 7
8	I/O Slot No. 8
9	I/O Slot No. 9
10	I/O Slot No.10
11	I/O Slot No.11
12	Not Used
13	Not Used
14	Not Used
15	Not Used
16	Not Used

When is an I/O Module Healthy?

Four conditions must be met before an I/O module can indicate good health:

The slot must be traffic copped

The slot must contain a module with the correct personality.

Valid communications must exist between the module and the RIO interface at remote drops.

Valid communications must exist between the RIO interface at each remote drop and the I/O processor in the controller.

S908 I/O Communication Status Words

Status words 172 - 277 contain the I/O system communication status. Words 172 - 181 are global status words. Among the remaining 96 words, three words are dedicated to each of the 32 drops, depending on the type of 984 controller you are using.

Word 172

S908 Startup Error Code. This word is always 0 when the system is running. If an error occurs, the controller does not start - it generates a stop state code of 10 (word 5):

TRAFFIC COP VALIDATION SOFT ERROR CODES

- 01 BADTCLEN Traffic Cop length
- 02 BADLNKNUM Remote I/O link number
- 03 BADNUMDPS Number of drops in Traffic Cop
- 04 BADTCSUM Traffic Cop checksum
- 10 BADDLEN Drop descriptor length
- 11 BADDRPNUM I/O drop number
- 12 BADHUPTIM Drop holdup time
- 13 BADASCNUM ASCII port number
- 14 BADNUMODS Number of modules in drop
- 15 PRECONDRP Drop already configured
- 16 PRECONPRT Port already configured
- 17 TOOMNYOUT More than 1024 output points
- 18 TOOMNYINS More than 1024 input points
- 20 BADSLTNUM Module slot address
- 21 BADRCKNUM Module rack address
- 22 BADOUTBC Number of output bytes
- 23 BADINBC Number of input bytes
- 25 BADRF1MAP First reference number
- 26 BADRF2MAP Second reference number
- 27 NOBYTES No input or output bytes
- 28 BADDISMAP Discrete not on 16-bit boundary

- 30 BADODDOUT Unpaired odd output module
- 31 BADODDIN Unpaired odd input module
- 32 BADODDREF Unmatched odd module reference
- 33 BAD3X1XRF 1x reference after 3x register
- 34 BADDMYMOD Dummy module reference already used
- 35 NOT3XDMY 3x module not a dummy
- 36 NOT4XDMY 4x module not a dummy
- 40 DMYREAL1X Dummy, then real 1x module
- 41 REALDMY1X Real, then dummy 1x module
- 42 DMYREAL3X Dummy, then real 3x module
- 43 REALDMY3X Real, then dummy 3x module

Word 173

Cable A error word.

Bit No.	Condition
1-8	Framing Error Count
9-16	DMA Receiver Overrun Count

Word 174

Cable A error word.

Bit No.	Condition
1-8	Receiver Error Count
9-16	Bad Drop Reception Count

Word 175

Cable A error word. Displays the last received LAN error code:

If the bit is set to 1, then the condition is TRUE.

Bit No.	Condition
1	Short Frame
2	No End-of-Frame
3	Not Used
4	Not Used
5	Not Used
6	Not Used
7	Not Used
8	Not Used
9	Not Used
10	Not Used
11	Not Used
12	Not Used
13	CRC Error
14	Alignment Error
15	Overrun Error
16	Not Used

Word 176

Cable B error word.

Bit No.	Condition
1-8	Framing Error Count
9-16	DMA Receiver Overrun Count

Word 177

Cable B error word.

Bit No.	Condition
1-8	Receiver Error Count
9-16	Bad Drop Reception Count

Word 178

Cable B error word. Displays the last received LAN error code:

If the bit is set to 1, then the condition is TRUE.

Bit No.	Condition
1	Short Frame
2	No End-of-Frame
3	Not Used
4	Not Used
5	Not Used
6	Not Used
7	Not Used
8	Not Used
9	Not Used
10	Not Used
11	Not Used
12	Not Used
13	CRC Error
14	Alignment Error
15	Overrun Error
16	Not Used

Word 179

Displays the global communication status:

If the bit is set to 1, then the condition is TRUE.

Bit No.	Condition
1	Communication Health
2	Cable A Status
3	Cables B Status
4	Not Used
5-8	Lost Communication Counter
9-16	Cumulative Retry Counter

Word 180

Global Cumulative Error Counter for Cable A

Bit No.	Condition
1-8	Detected Error Count
9-16	No Response Count

Word 181

Global Cumulative Error Counter for Cable B

Bit No.	Condition
1-8	Detected Error Count
9-16	No Response Count

Words 182 - 277 (Remote I/O Only)

For controllers that support remote I/O, words 182 - 277 are used to describe remote I/O drop status, three status words for each drop.

Word	Drop
182 - 184	Drop 1
185 - 187	Drop 2
“ “ “	“ “
275 - 277	Drop 32

Each group of RIO drop status word is organized as follows:

Word 1

Displays communication status:

If the bit is set to 1, then the condition is TRUE.

Bit No.	Condition
1	Communication Health
2	Cable A Status
3	Cables B Status
4	Not Used
5-8	Lost Communication Counter
9-16	Cumulative Retry Counter

Compact 984 Status

The Compact 984 Status Table

Decimal Word		Hex Word
1	Controller Status	01
2	Not Used	02
3	Controller Status	03
4	Not Used	04
5	Controller Stop State	05
6	Number of Segments in User Logic	06
7	Address of End-of-logic Pointer	07
8	To be Defined	08
9	Not Used	09
10	Run/Load/Debug Status	0A
11	Not Used	0B
12	Rack 1 I/O Module Health	0C
13	Rack 2	0D
14	Rack 3	0E
15	Rack 4	0F
16-181	Not Used	
182-184	Drop Status	B6-B8

S984 Compact Controller Status Words

Words 1 through 11 display the controller status words.

Bits in a word are numbered 1 to 16 and progress from left to right. Bit 1 is the most significant bit (MSB). Bit 16 is the least significant bit (LSB).

Word 1

Displays the following aspects of the controller's status:

If the bit is set to 1, then the condition is TRUE.

Bit No.	Condition
1	Not Used
2	Not Used
3	Not Used
4	Not Used
5	Not Used
6	Enable Constant Sweep
7	Enable Single Sweep Delay
8	1 = 16-Bit User Logic
9	AC Power ON
10	Run Light OFF
11	Memory Protect is OFF
12	Battery Failed
13	Not Used
14	Not Used
15	Not Used
16	Not Used

Word 2

Not Used.

Word 3

Displays the following aspects of the controller's status:

If the bit is set to 1, then the condition is TRUE.

Bit No.	Condition
1	First Scan
2	Start Command Pending
3	Constant Sweep Times Exceeded
4	Exiting DIM AWARENESS
5	Not Used
6	Not Used
7	Not Used
8	Not Used
9	Not Used
10	Not Used
11	Not Used
12	Not Used
13	Single Sweeps
14	Single Sweeps
15	Single Sweeps
16	Single Sweeps

Word 4

Not used.

Word 5

Displays the controller's stop state conditions:

If the bit is set to 1, then the condition is TRUE.

Bit No.	Condition
1	Peripheral Port Stop
2	Not Used
3	Controller in DIM AWARENESS
4	Illegal Peripheral Intervention
5	Segment Scheduler Invalid
6	Start of Node Did Not Start Segment
7	State RAM Test Failed
8	No End of Logic
9	Watchdog Timer Expired
10	Real Time Clock Error
11	CPU Logic Solver Failed
12	Not Used
13	Invalid Node
14	Logic Checksum
15	State Checksum
16	Bad Configuration

Word 6

Displays the number of segments in ladder logic; a binary number is shown:

Bit No.	Condition
1-16	Number of Segments (expressed as a binary number)

Word 7

Displays the address of the end-of-logic (EOL) pointer:

Bit No.	Condition
1-16	ROL Pointer Address

Word 8

In the Compact 984-145 controller, word 8 is used to store a numerical value that defines the upper limit of memory locations on page 0 where user logic can be placed. This value is not user-configurable and is used only by the programming panel.

Word 9

Not Used

Word 10

Uses its two least significant bits to display the RUN/LOAD/DEBUG status:

If the bit is set to 1, then the condition is TRUE.

Bit No.	Condition
1	Not Used
2	Not Used
3	Not Used
4	Not Used
5	Not Used
6	Not Used
7	Not Used
8	Not Used
9	Not Used
10	Not Used
11	Not Used
12	Not Used
13	Not Used
14	Not Used
15	Debug = 0, Run = 0, Load = 1
16	Debug = 0, Run = 1, Load = 0

Word 11

Word 11 is not used.

Compact 984 I/O Module Health Status Words

Words 12 through 15 display the health of the I/O modules:

Decimal Word		Hex Word
12	Drop 1, Rack 1	0C
13	Drop 1, Rack 2	0D
14	Drop 1, Rack 3	0E
15	Drop 1, Rack 4	0F

If the bit is set to 1, then the condition is TRUE.

Bit No.	Slot No.
1	I/O Slot No. 1
2	I/O Slot No. 2
3	I/O Slot No. 3
4	I/O Slot No. 4
5	I/O Slot No. 5
6-16	Not Used

If a module is Traffic Cop'd and active, the bit will be 1.

If a module is inactive or not Traffic Cop'd, the bit will be 0.

In the primary rack bits 1 and 2 (slots 1 and 2) are not used because the processor is placed in these slots.

Compact 984 I/O Communication Status Words

There are three words that contain information on the communication of the entire drop. If monitored with the STAT block, they can be found in words 182 through 184. This would require that the length of the STAT block be a minimum of 184. Words 17 through 181 would not be used.

Word 182

Displays local drop status.

Bit No.	Slot No.
1	All Modules Healthy
2	Always 0
9-16	Number of Times a Module has Been Seen as Unhealthy. Count will Roll Over at 255

Word 183

I/O Error Counter. This counter is similar to the one in Word 182 with one exception. If a module becomes unhealthy, word 182 is incremented by one while Word 183 is incremented each scan until the module is healthy again.

Word 184

PAB Bus Retry Counter. Diagnostics are performed on the communication of the bus. This word should normally be zeros. If after five retries a bus error is still detected, the controller will be stopped.

Modicon Micro PLC Status Table

The Modicon Micro PLCs maintain a table in memory that contains vital system diagnostic information regarding the PLC, its I/O, and its communications. This table is 56 words long, and its contents are structured as follows:

Words 1 through 11 contain PLC status information.

Words 12 through 31 contain the health of I/O locations.

Word 32 contains error codes generated at system start-up.

Words 33-36 contain global communications status.

Words 37-40 contain the health of I/O communications at the local drop.

Words 41-56 contain the health of I/O communications to and from the remote drops.

Bits in a word are numbered 1 to 16 and progress from left to right. Bit 1 is the most significant bit (MSB). Bit 16 is the least significant bit (LSB).

Word 1

Displays the CPU status.

If the bit is set to 1, then the condition is TRUE.

Bit No.	Condition
1	Not Used
2	Not Used
3	Not Used
4	Not Used
5	Not Used
6	Enable Constant Sweep
7	Enable Single Sweep Delay
8	0 = 24-Bit User Logic 1 = 16-Bit User Logic
9	Not Used
10	Run Light OFF
11	Not Used
12	Battery Failed
13	Not Used
14	Not Used
15	Debug = 0, Run = 0, Load = 1
16	Debug = 0, Run = 1, Load = 0

Word 2

Displays the PLC drop address.

Bit No.	Slot No.
1 - 13	Not Used
14-16	See Below

PLC Configuration	Hexidecimal (Bits 14 15 16)
PLC is configured in single or parent mode	0 0 1
PLC is configured as child #1 on an expanded I/O network	0 1 0

PLC is configured as child #2 on an expanded I/O network	0 1 1
PLC is configured as child #3 on an expanded I/O network	1 0 0
PLC is configured as child #4 on an expanded I/O network	1 0 1

Word 3

Displays more PLC status.

If the bit is set to 1, then the condition is TRUE.

Bit No.	Condition
1	First Scan
2	Start Command Pending
3	Constant Sweep Times Exceeded
4	Not Used
5	Not Used
6	Not Used
7	Not Used
8	Not Used
9	Not Used
10	Not Used
11	Not Used
12	Not Used
13	Single Sweeps
14	Single Sweeps
15	Single Sweeps
16	Single Sweeps

Word 4

Displays the maximum number of drops allowed in an I/O/O network.

Bit No.	Condition
1 - 12	Not Used
13	Single Sweeps
14	1*
15	0 *
16	0 *

*Always set to 4.

Word 5

CPU Stop State Conditions

If the bit is set to 1, then the condition is TRUE.

Bit No.	Condition
1	Peripheral Port Stop
2	Error in the I/O map
3	Not Used
4	Illegal Peripheral Intervention
5	Segment Scheduler Invalid
6	No SON at the start of the segment
7	State RAM Test Failed
8	Invalid number of DOIOs/EOLs
9	Watchdog Timer Expired
10	Real Time Clock Error
11	Mismatch between coil use table and coils in ladder logic
12	Fatal Error on the A120 I/O Link
13	Invalid Node in Ladder Logic
14	Logic Checksum Error
15	Coil disabled in RUN mode
16	Bad PLC Setup

Word 6

Displays the number of segments in ladder logic; a binary number is shown:

Bit No.	Condition
1 - 16	Number of Segments (expresses as a binary number)

Word 7

Displays the address of the end-of-logic (EOL) pointer:

Bit No.	Condition
1 - 16	ROL Pointer Address

Word 8

Not Used

Word 9

Not Used

Word 10

Uses its two least significant bits to display the RUN/LOAD/DEBUG status:

If the bit is set to 1, then the condition is TRUE.

Bit No.	Condition
1	Not Used
2	Not Used
3	Not Used
4	Not Used
5	Not Used
6	Not Used
7	Not Used
8	Not Used
9	Not Used
10	Not Used
11	Not Used
12	Not Used
13	Not Used
14	Not Used
15	Debug = 0, Run = 0, Load = 1
16	Debug = 0, Run = 1, Load = 0

Word 11

Word 11 is not used.

Micro Health Status Words

Words 12 through 31 display the health of the I/O modules:

Four contiguous words are used for each of the five Modicon Micro PLCs on an I/O expansion network; one word in each group of four is used for each possible I/O rack, assuming A120 I/O expansion:

Decimal Word	
12	PLC 1, Rack 1
13	PLC 1, Rack 2
14	PLC 1, Rack 3
15	PLC 1, Rack 4
16	PLC 2, Rack 1
17	PLC 2, Rack 2
18	PLC 2, Rack 3
19	PLC 2, Rack 4
20	PLC 3, Rack 1
21	PLC 3, Rack 2
22	PLC 3, Rack 3
23	PLC 3, Rack 4
24	PLC 4, Rack 1
25	PLC 4, Rack 2
26	PLC 4, Rack 3
27	PLC 4, Rack 4
28	PLC 5, Rack 1
29	PLC 5, Rack 2
30	PLC 5, Rack 3
31	PLC 5, Rack 4

Rack 1 is always a Modicon Micro PLC, and racks 2 through 4 are A120 I/O racks connected to rack 1 via an A120 I/O expansion port.

Each word contains five representative bits that show health of the associated I/O unit in each rack. For example, each rack can support a maximum of five I/O locations:

If the bit is set to 1, the slot contains a healthy I/O unit.

Bit No.	Slot No.
1	Location No. 1
2	Location No. 2
3	Location No. 3
4	Location No. 4
5	Location No. 5
6-16	Not Used

With respect to A120 I/O modules, a location is the physical slot position of the module in its DTA housing. With respect to the Modicon Micro PLC, the location relates to the following fixed components on the unit:

Location 1 represents the fixed discrete inputs and outputs on the unit.

Location 2 represents the dedicated interrupt component status on the unit.

Location 3 represents the user-selectable counter/timer count on the unit.

Location 4 represents any fixed analog inputs and outputs on the unit.

Location 5 represents the data transfer component on the unit for serial I/O expansion.

An I/O location is healthy when it is configured and I/O mapped correctly, its personality is correct, and valid communications exist between it and the CPU that controls it.

Word 32

Start-Up Error Codes (Always 0 when the system is running properly)

Bits 11 through 16

Decimal Word		Hex Word
01	Bad I/O map length	000001
02	Bad link no. for child PLCs on network	000010 ³
03	Wrong no. of child PLCs in I/O map	000011
04	Bad I/O map checksum	000100
10	Bad child PLC descriptor length	001010
11	Number of segments in user logic	001011
12	Bad holdup time for child PLC on network	001100
13	Bad ASCII port number	001101
14	Bad no. of slots in a child PLC	001110

15	Child PLC has already been set up	001111
16	Comm port has already been set up	010000
17	More than 1024 output points	010001
18	More than 1025 input points	010010
20	Bad slot address	010100
21	Bad rack address	010101
22	Bad number of output bytes	010110
25	Bad first reference number	011001
26	Bad second reference number	011010
27	No input or output bytes	011011
28	Discrete not on a 16-bit boundary	011100
30	Unpaired odd output unit	011110
31	Unpaired odd input unit	011111
32	Unmatched odd input/output unit reference	100000
33	1x reference after 3x register	100001
34	Dummy unit reference already used	100010
35	3x reference not a dummy	100011
36	4x reference is not a dummy	100100
40	Dummy, then real 1x reference	101000
41	Real, then dummy 1x reference	101001
42	Dummy, then real 3x reference	101010
43	Real, then dummy 3x reference	101011
44	Too many I/O points in a drop	101100
50	Bad unit descriptor rack	110010
51	Bad unit descriptor slot	110011
52	Bad unit descriptor input byte count	110100
53	Bad unit descriptor output byte count	110101
54	I/O driver has not been loaded	110110
55	Unit can be used only in rack	110111

Word 33

Global Communications

For a parent- or single-mode PLC:

Bit No.	Condition
1	0 = unsuccessful communication to any child on the I/O expansion net
2 - 8	Not Used
9 - 16	Number of non-recoverable communication losses at any PLC
11	Setup on the I/O expansion net.

For a child-mode PLC:

Bit No.	Condition
1	0 = child has not received a valid output command from the parent before holdup time has expired.
2 - 8	Not Used
9 - 16	Number of times the child's holdup time has expired.

Word 34

Additional Global Communications

For a parent-mode PLC:

Bit No.	Condition
1 - 8	Number of no responses of the system
9 - 16	Number of retries due to a previous comm error

For a child-mode PLC:

Bit No.	Condition
1 - 16	Number of ms remaining before holdup time expires

Word 35

Additional Global Communications for a parent-mode PLC only

For a parent-mode PLC only:

Bit No.	Condition
1 - 8	Number of parity errors detected on received characters
9 - 16	Number of framing errors detected on received characters

Word 36

Additional Global Communications for a parent-mode PLC only

For a parent-mode PLC only:

Bit No.	Condition
1	Last detected no response error
2	Last detected overrun error
3	Last detected framing error
4	Last detected parity error
5 - 8	Not Used
9 - 16	Number of overrun errors detected on received characters

Word 37

Healthy Communications in Rack 1 (for A120 expansion only)

If the bit is set to 1, then condition is TRUE.

For a parent-mode PLC only:

Bit No.	Condition
1	All units healthy
2 - 8	Not Used
9 - 16	Number of times any local unit goes from healthy to unhealthy

Word 38

I/O Error Detection in Rack 1 (for A120 I/O expansion only)

Bit No.	Condition
1 - 16	Number of times an error has been detected while communicating with I/O.

Word 39

I/O Retry Counter in Rack 1 (for A120 I/O expansion only)

Bit No.	Condition
1 - 16	Number of times a retry has been logged to a local I/O location

Word 40

Not used.

Word 41 - 56

These are for communications on the I/O expansion network - they have meaning only on parent mode.

Each potential child PLC on the network is described by a group of four contiguous words:

Words 41 through 44 apply to child # 1

Words 45 through 48 apply to child # 2

Words 49 through 52 apply to child # 3

Words 53 through 56 apply to child # 4

Words 41, 45, 49, 53 Format:

Bit No.	Condition
1	0 = unsuccessful communication from parent to a specific child 1 = successful communication at a specific child
9 - 16	Number of nonrecoverable communication losses at the specific child

Words 42, 46, 50, 54 Format:

Bit No.	Condition
1 - 8	Number of no responses from a specific child
9 - 16	Number of retries due to a previous comm error at a specific child

Words 43, 47, 51, 55 Format:

Bit No.	Condition
1 - 8	Number of CRC errors detected on received characters from a specific child
9 - 16	Number of framing errors detected on received characters from a specific child

Words 44, 48, 52, 56 Format

Bit No.	Condition
1	Last detected no response error
2	Last detected overrun error
3	Last detected framing error
4	Last detected CRC error
5-8	Not Used
9-16	Number of overrun errors detected on received characters

16 - Special Instructions

DISA (Disabled Monitor System)

Description

Disabled Monitor System (DISA) monitors the disabled states of all coils and discrete inputs. The quantity and reference number of the disabled states are logged into simple data tables.

Function Block

Top Node	Contains a table in which the first register contains the number of disabled coils and the registers after that contain the reference numbers of the disabled coils. Use a 4XXXX reference.
Middle Node	Contains a table in which the first register contains the number of disabled inputs and the registers after that contain the reference numbers of the disabled inputs. Use a 4XXXX reference.
Bottom Node	Contains the maximum number of disabled coils/inputs to be stored by the DISA instruction.

HIST (Discrete Logic Analyzer/Histogram)

Description

The Discrete Logic Analyzer/Histogram (HIST) instruction monitors a single input or coil state for 1600 consecutive scans of the logic.

Function Block

Top Node Contains the information to setup the trace function. Use a 4XXXXXX register.

Middle Node Contains the registers used to store the status of the input or output coils selected to be monitored. Use a 4XXXXXX register.

Bottom Node Contains the number of successive scans over which to trap the value of the coil or input. A number from 1 to 100 is used to indicate 16 to 1600 scans

SKIP

Description

The Skip function allows logic in a group of networks to be skipped, and thus not solved in order to reduce scan time. The Skip function can be used to bypass seldom-used program sequences or to create subroutines.

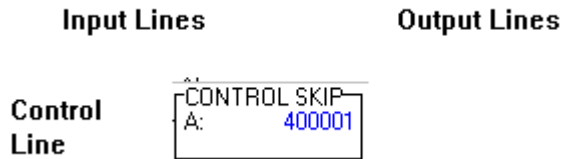

INPUT LINES

Control Line The top and only input, when receiving power, causes the remainder of the current network and the specified number of networks to be skipped over by the processor's scan.

Output Lines None

Function Block

The function block only occupies one node in a network. It contains the SKIP symbol and either a constant or a register reference. It can be a constant up to 999 in a 16-bit processor or up to 9999 in a 24-bit processor, a 3XXXX input register reference, or a 4XXXX holding register reference. If a 4XXXX reference is used, it should be unique to this function block to avoid mishaps (i.e., using the same register to hold a counter value, etc.). The value specifies the number of networks to be skipped. To skip the remainder of the networks in the current segment, a value of zero is entered into the function block or register.

NOTE: If a 3XXXX input register is used and the input is coming from a thumbwheel, the data read by the processor can be incorrect (i.e., if it was read while the number was still being entered). In order to use a thumbwheel and ensure a correct number, use a 4XXXX reference in the Skip block and use a Subtract block to subtract zero from the input register to load it into the holding register prior to the Skip.

The Skip function cannot pass the boundary of a segment. Regardless of how many networks were programmed to be skipped, the function stops when it reaches the end of a segment. Also, using Skips within Skips causes the processor to shut down.

Programming Example

The following example illustrates a ladder diagram network using a Skip function.

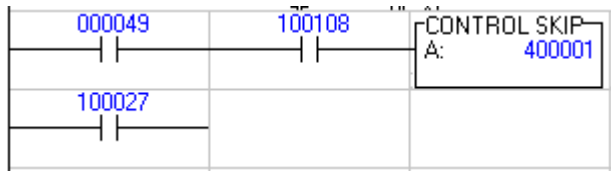

When the Skip function block's input receives power, the remainder of the network containing the block (if any) is skipped and the next six networks are skipped. If network 17 contains the Skip function, the remainder of 17 and all of 18-23 are skipped. If there are only five networks left in the segment, the operation stops after the fifth network.

READ (ASCII Read Function)

Description

The Read function allows the 984-80 PLC to read data from an ASCII device through a J812 Remote I/O Adapter or a P453 Power Supply, or a J892 800 Series I/O Interface. The data is stored in a table of registers.

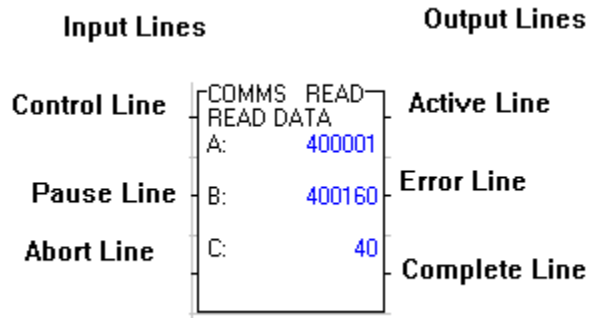

INPUT LINES

Control Line The top input controls the operation. When this input transitions from OFF to ON the Read function is performed.

Pause Line The middle input, when receiving power, stops the Read function. When this input loses power, the Read function resumes where it left off.

Abort Line The bottom input, when it receives power, stops/aborts the operation. The top input must be cycled for the function to begin again; it does not resume where it left off.

OUTPUT LINES

Active Decode Line The top output, when passing power, indicates that the Read function is communicating with the specified port (FUNCTION ACTIVE).

Error Decode Line The middle output passes power for one scan when an error is detected. The error code is placed in either the 4 most significant bits of the source's first register or the next 6 bits.

First 4 bits = 984-80 error

Next 6 bits = J812 Remote I/O Interface error

For a list of the error codes, see the *Modicon ASCII Programming Guide*.

Complete Decode Line The bottom output passes power for one scan when the operation is complete.

FUNCTION BLOCK

Top Node The top node is the source node. It is a 4XXXX holding register reference. It refers to a table of 7 consecutive registers. The table starts with the reference in the top node; the next 6 registers are implied. These registers must be unique to this function block.

The following are the table register assignments:

4XXXX = bits 0 - 5: port numbers (1-32) bits 6 - 15: error codes

4XXXX + 1 = message number

4XXXX + 2 = number of registers required to satisfy format

4XXXX + 3 = number of registers transmitted

4XXXX + 4 = status of solve

4XXXX + 5 = unassigned

4XXXX + 6 = checksum of registers 0 – 5

Middle Node The middle node is the destination node. It is a 4XXXX holding register reference. It is the reference to the first register in a table of registers whose length is determined by the value in the bottom node. The information read by the processor is stored in these registers.

Bottom Node The bottom node contains the numerical value that specifies the destination table length. This constant can range from 1 - 255 for a 16-bit CPU and 1 - 99 for a 24-bit CPU.

WRIT (ASCII Write Function)

Description

The Write function transmits data from the 984-80 PLC through a J812 Remote I/O Adapter, a P453 Power Supply, or a J892 800 Series I/O Interface, to an ASCII device.

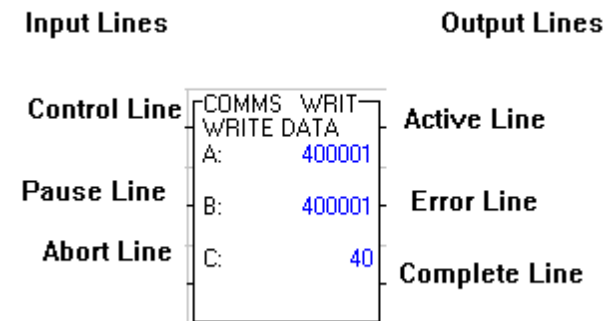

INPUT LINES

Control Line The top input controls the operation. When this input transitions from OFF to ON the Write function is performed.

Pause Line The middle input, when receiving power, stops the Write function. When this input loses power, the Write function resumes where it left off.

Abort Line The bottom input, when receiving power, stops/aborts the operation. The top input must be cycled for the function to begin again; it does not resume where it left off.

OUTPUT LINES

Active Decode Line The top output, when passing power, indicates that the Write function is communicating with the specified port (FUNCTION ACTIVE).

Error Decode Line The middle output passes power for one scan when an error is detected. The error code is placed in either the 4 most significant bits of the source's first register or the next 6 bits.

For the -80

First 4 bits = 984-80 error

Next 6 bits = J812 Remote I/O Interface Error

For the 584

First 4 bits = 584 error

Next 4 bits = P453 Remote I/O Interface Error

For the 984

First 4 bits = 984 error

Next 6 bits = J812 Remote I/O Interface error

For a list of error codes, see the Modicon ASCII Programming Guide.

Complete Decode Line The bottom output passes power for one scan when the operation is complete.

**FUNCTION
BLOCK**

Top Node The top node is the source node. It can be either a 3XXXX input register or a 4XXXX holding register reference. It is the reference to the first register in a table of registers.

Middle Node The middle node is the source node. It is a 4XXXX holding register reference. It refers to a table of 7 consecutive registers. The table starts with the reference in the top node; the next 6 registers are implied. These registers must be unique to this function block.

The following are register assignments:

4XXXX = bits 0 - 5: port numbers (1-32) bits 6 - 15: error codes

4XXXX + 1 = message number

4XXXX + 2 = number of registers required to satisfy format

4XXXX + 3 = number of registers transmitted

4XXXX + 4 = status of solve

4XXXX + 5 = unassigned

4XXXX + 6 = checksum of registers 0 – 5

Bottom Node The bottom node contains the numerical value that specifies the source table length. This constant can range from 1 - 255 for a 16-bit CPU and from 1 - 999 for 24-bit CPU.

Programming Example

The following example illustrates a network with a Write function.

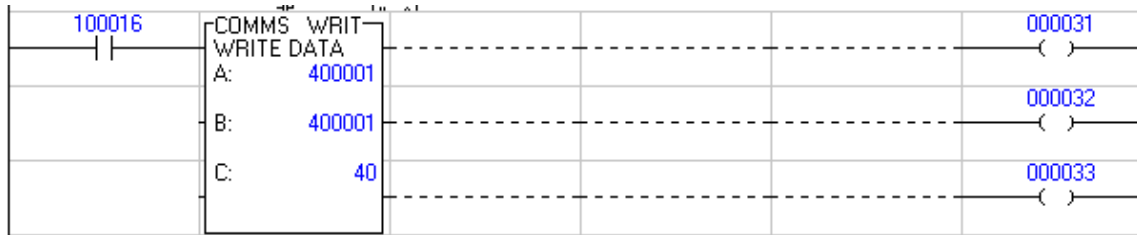

When input 10016 transitions from OFF to ON, the top input receives power and starts to write information to an ASCII device. The information is taken from registers 30001-30040. The top output passes power and energizes coil 00031 while the Write is taking place. If an error is found, the middle output passes power for one scan, energizing coil 00032. When the Write is complete, the bottom output passes power and energizes coil 00033.

A Write to any “reserved” ASCII holding register does not set the error output.

A Write to a busy ASCII port does not set the busy flag.

The Write block issues a done flag when the ASCII message is “sent” to the P453, instead of when it is actually “sent”.

XMRD (Extended Memory Read)

Description

The Extended Memory Read function transfers data from a file in the 984's extended memory to a block of 4XXXX holding/output registers. This instruction appears only in the processors that have extended memory.

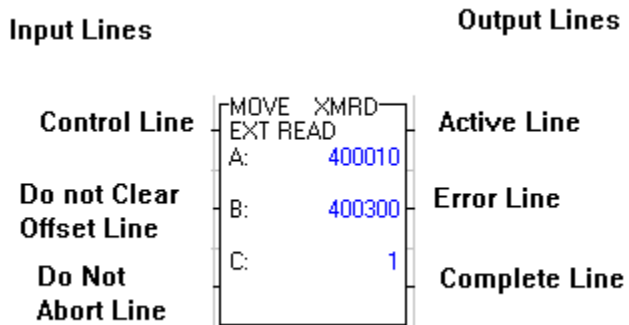

XMWT (Write Extended Memory)

Description

The Write Extended Memory function transfers data from a block of 3XXXX input registers or 4XXXX holding/output registers to a block of registers in a 984 extended memory file. This instruction is available only in the processors that have extended memory.

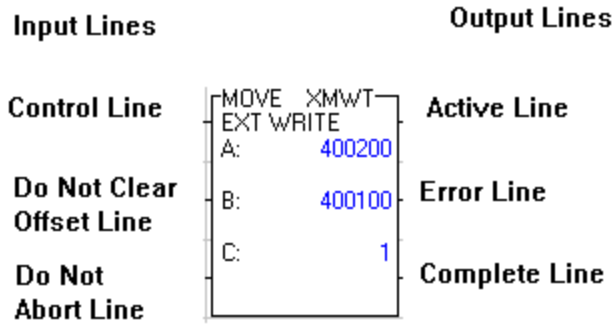

INPUT LINES

- Control Line** The top input controls the operation. When this input receives power, the extended memory write function is performed.
- Do Not Clear Offset Line** The middle input, when receiving power, copies the offset value (4XXXX + 4) and uses it in the function. If not receiving power, the copy of the offset register is cleared to zero before the function is performed.
- Do Not Abort Line** The bottom input, when receiving power, does not automatically stop the 984 processor if a dynamic memory (parity) or power-up diagnostic error is detected. If not receiving power, the 984 processor stops if an error is detected.

OUTPUT LINES

- Active Decode Line** The top output, when passing power, activates the extended memory write function.
- Error Decode Line** The middle output passes power when a power-up, memory, hardware, or syntax error is detected. It continues to pass power until the faulty data and/or hardware are corrected.
- Complete Decode Line** The bottom output passes power for one scan when the data transfer is complete.

**FUNCTION
BLOCK**

Top Node The top node is the source node. It can be either a 3XXXX input register or a 4XXXX holding/output register reference. It specifies the first register in a table of registers; the contents of the registers are written to extended memory.

Middle Node The middle node contains a 4xxxx holding/output register reference that specifies the first register in a six-register control table. If using the multiple scan option, the registers in the middle node should be unique to this function block. The control table register assignments are:

4XXXX = status word

4XXXX + 1 = extended memory file number (1 to 10)

4XXXX + 2 = starting address in the file (0 to 9999)

4XXXX + 3 = count of words transferred per scan (0 to 9999)

4XXXX + 4 = offset value. This value is added to the starting address (4XXXX + 2) for an effective starting address in extended memory. The same value is also added to the source register value, for an effective starting address as a source field for the register being transferred to extended memory. At the end of each transfer, the count of words transferred is added to this value.

4XXXX + 5 = number of registers to be transferred (0 to 9999)

Bottom Node The bottom node contains the value 00001. This value cannot be changed.

Programming Example

The following example illustrates a network with a XMWT function.

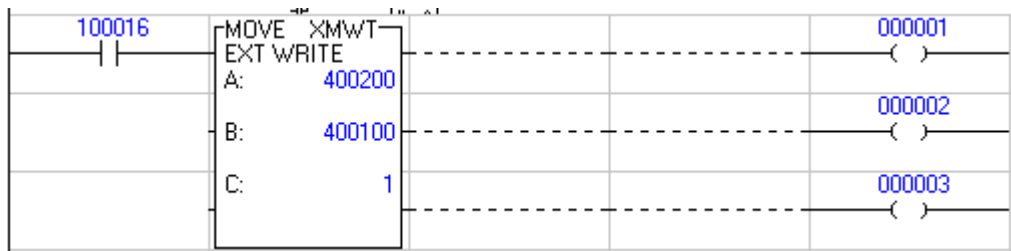

A block of 1000 4XXXX registers is written in one scan to extended memory. The block starts at register 41000 and is written to a block starting at register 2000 in file two. The control table, displayed in the following figure, begins at register 40100. The value, 0002, in register 40101, is the extended memory file number.

The block of registers is written to the location in extended memory indicated by the value, 2000, in register 40102.

The value 1000 in register 40103 indicates the number of registers transferred per scan.

Register 40104 contains the offset count that changes throughout the function.

The value 1000 in register 40105 indicates the total number of registers being transferred.

Coil 00001 is energized when the function block is an active and coil 00003 is energized when the write is complete. Coil 00002 is used to indicate an error.

XMIT (Transmit)

XMIT (Transmit) Description

The XMIT (Transmit) function block communicates via Modbus from a “master” PLC to multiple “slave” PLCs or sends ASCII character strings from the PLC’s Modbus slave port 1 or port 2 to ASCII printers and terminals. Communication is possible over telephone dial-up modems, radio modems, or a direct serial connection.

XMIT comes with three modes: a communication, port status, and a conversion mode. In the communications mode the execution of the XMIT block performs general ASCII input functions including both simple and terminated ASCII. An additional XMIT block may be used for reporting port status information into registers while another XMIT block performs the ASCII communication function. Binary data or ASCII may be imported or exported into the PLC and converted to send to DCE devices per your application’s needs.

The XMIT block contains built-in diagnostics to allow no other active XMIT blocks within the PLC. This is provided for by the use of a control table; this table controls the communications link between the PLC and DCE (Data Communication Equipment) devices attached to Modbus port 1 or port 2 of the PLC. The XMIT block doesn’t activate the port LED when it’s transmitting data.

NOTE: The Modbus protocol is a “master/slave” protocol and designed to have only one master when polling multiple slaves. Therefore, when using the XMIT block in a network with multiple masters, contention resolution and collision avoidance is your responsibility and may easily be addressed through ladder logic programming.

NOTE: For more detailed information on the XMIT function block, see Modicon’s XMIT Function Block User Guide (840 USE 113 00 v3.00).

Communications Block

XMIT Communication Block

The XMIT communication block lets you transmit data directly out of the PLC. You can set the parity, stop bits, pulse or tone dialing (among other values) just like a modem.

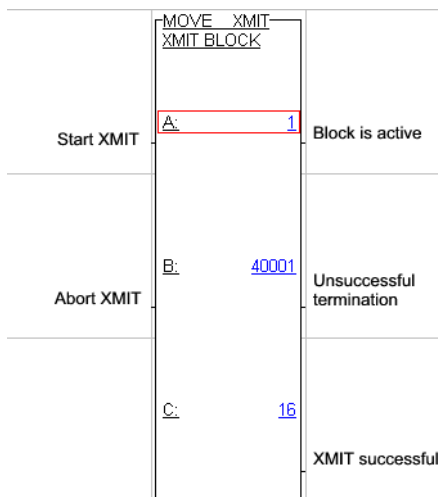

	Inputs	Outputs
Top Node	Begins operation and should remain on until completed or an error has occurred. This node must contain the constant 0001 or 0002 to select the corresponding port address.	Output goes ON during operation.
Middle Node	Aborts operation and forces port to “slave” mode; port remains closed so long as input is ON. Abort code (121) is sent to the fault status register. The 4x register is the first in a group of 16 contiguous holding registers of the control block.	Output goes ON when an error is detected or an abort has been issued.
Bottom Node		Output goes on when block has completed successfully. This node must contain a constant equal to 16, as this is the number of registers used.

NOTE: To clear fault register and rest XMIT, the top input node must go off for at least one scan.

	Warning	Do not modify the address in the 4xxxx middle node or delete XMIT from the program while the block is active. This locks up the communication port, preventing further communications.
---	----------------	--

The XMIT instruction block will not operate correctly if:

The NSUP and XMIT loadables are not installed.

The NSUP loadable is installed after the XMIT loadable

The NSUP and XMIT loadables are installed in a Quantum PLC with an out-of-date executive (older than version 2.10 or 2.12)

Registers in the XMIT control block are as follows:

4x: Revision Number (read only; decimal)

4x+1: Fault Status (read only)

4x+2: (available to user *)

4x+3: Data Rate (50, 75, 110, 134, 150, 300, 600, 1200, 2400, 9600, or 19200 bits per second)

4x+4: Data Bits (7, 8)

4x+5: Parity (0, 1, 2)

4x+6: Stop Bits (0, 1, 2)

4x+7: (available to user *)

4x+8: Command Word (16-digit binary number).

4x+9: Pointer to Message Table (message pointer). Values are limited by the range of 4x registers configured

4x+10: Length of Message (0 - 512)

4x+11: Response Timeout (0 - 65535 milliseconds)

4x+12: Retry Limit 0-65535

4x+13: Start of Transmission Delay (0 - 65535 milliseconds)

4x+14: End of Transmission Delay (0 - 65535 milliseconds)

4x+15: Current Retry (read only)

NOTE: The XMIT block does not use registers 4x+2 and 4x+7. They are freely available.

XMIT Fault Status (4x+1)

Contains a fault code (read only):

Code	Description
-------------	--------------------

1	Modbus exception: Illegal function
2	Modbus exception: Illegal data address
3	Modbus exception: Illegal data value
4	Modbus exception: Slave device failure
5	Modbus exception: Acknowledge
6	Modbus exception: Slave device busy
7	Modbus exception: Negative acknowledge
8	Modbus exception: Memory parity error
9 - 99	Reserved
100	Slave PLC data area cannot equal zero
101	Master PLC data area cannot equal zero
102	Coil (0x) not configured
103	Holding register (4x) not configured
104	Data length cannot equal zero
105	Pointer to message table cannot equal zero

- 106 Pointer to message table outside range of configured holding registers (4x)
- 107 Transmit message time-out (generated when UART cannot complete a transmission in 10 seconds or less. This bypasses the retry counter, activating the error output on the first error)
- 108 Undefined error
- 109 Modem returned ERROR
- 110 Modem returned NO CARRIER
- 111 Modem returned NO DIALTONE
- 112 Modem returned BUSY
- 113 Invalid LRC checksum from slave PLC
- 114 Invalid CRC checksum from slave PLC
- 115 Invalid Modbus function code
- 116 Modbus response message time-out
- 117 Modem reply time-out
- 118 XMIT could not gain access to PLC communications port #1
- 119 XMIT could not enable PLC port receiver
- 120 XMIT could not set PLC UART
- 121 User issued abort command
- 122 Top node of XMIT not equal to 1 (#0001)
- 123 Bottom node of XMIT not equal to 16 (#0016)
- 124 Undefined internal state
- 125 Broadcast mode not allowed with this Modbus function code
- 126 DCE did not assert CTS
- 127 Illegal configuration (data rate, data bits, parity, or stop bits)
- 128 Unexpected response received from Modbus slave
- 129 Illegal command word setting

XMIT Command Word (4x+8)

Each bit of the command word is interpreted as a function or operation to perform. Error 129 in the Fault Status (4x+1) register will be generated if:

Bits 7 and 8 are on simultaneously

Any two or more of bits 13, 14, 15, or 16 are on simultaneously

Bit 7 is not on when bits 13, 14, 15, or 16 are on

Individual meanings of the bits are as follows:

Bit Description

1 Reserved

2 Enable RTS/CTS control: Set this to 1 when a DCE connected to the PLC needs hardware handshaking using RTS/CTS control.

Start of Transmission Delay register (4x+13) keeps RTS asserted (for X ms) before the message is sent out of PLC port #1.

End of Transmission Delay register (4x+14) keeps RTS asserted (for X ms) after the message is sent out of PLC port #1. When the delay expires, RTS is de-asserted.

3 - 6 Reserved

7 Enable ASCII string messaging: Set this to 1 when you want to send ASCII messages out of the PLC.

The XMIT block sends ASCII strings of up to 512 characters.

You program each ASCII message into contiguous 4x registers on the PLC, two characters per register. Only use Bit 7 or Bit 8, not both.

8 Enable Modbus messaging: Set this to 1 when you want to send Modbus messages out of the PLC.

Modbus messages may be in RTU or ASCII. If Data Bits (4x+4) is 8, the message transmits in Modbus RTU format; if Data Bits is 7, Modbus ASCII. Only use Bit 7 or Bit 8, not both.

9 - 12 Reserved

13 Pulse dial modem: Set this to 1 to pulse dial a telephone number using a Hayes compatible dial-up modem.

Program the phone number into contiguous 4x

registers of the PLC, placing a pointer to it in the Pointer to Message Table register of the XMIT control table (4x+9) and the length in Length of Message (4x+10).

Pulse dialed numbers are automatically preceded by ATDP and with carriage return and line feed appended. Since the dial message is in ASCII, bit 7 must be ON prior to sending the number.

- 14** Hang up modem: Set this to 1 to hang up using a Hayes compatible dial-up modem.

Use ladder logic to turn this bit on. Since the dial message is in ASCII, bit 7 must be ON prior to sending the number.

Hang up messages are automatically preceded by +++AT and with carriage return and line feed appended.

The XMIT block looks for a correct disconnect response before indicating a successful completion.

- 15** Tone dial modem: Set this to 1 to tone dial a telephone number using a Hayes compatible dial-up modem.

Program the phone number into contiguous 4x registers of the PLC, placing a pointer to it in the Pointer to Message Table register of the XMIT control table (4x+9) and the length in Length of Message (4x+10).

Tone dialed numbers are automatically preceded by ATDT and with carriage return and line feed appended. Since the dial message is in ASCII, bit 7 must be ON prior to sending the number.

- 16** Initialize modem: Set this to 1 to initialize a Hayes compatible dial-up modem.

Program the initialization message into contiguous 4x registers of the PLC, placing a pointer to it in the Pointer to Message Table register of the XMIT control table (4x+9) and the length in Length of Message (4x+10).

Messages are automatically preceded by AT and with a carriage return and line feed appended. Since the initialization message is in ASCII, bit 7 must be on.

XMIT Message Pointer Word (4x+9)

Pointer to the beginning of a message table.

For ASCII strings, the pointer is the register offset to the first register of the string (each register holds up to two ASCII characters). Each ASCII string may be up to 512 characters.

For Modbus messages, the pointer is the register offset to the first register (4y in the table below) of the Modbus definition table. For Modbus function codes 01, 02, 03, 04, 05, 06, 15 and 16, the table must be five registers long; for codes 20 and 21, the table must be six registers.

Modbus Definition Table format

When storing register addresses in the Definition table, the first digit of the register address is automatically assumed based on the specific field and Modbus function code. For example, a function code 04 Read Multiple Input Registers command with 100 stored in 4y+3 indicates an address of 40100 for the Slave PLC data area.

XMIT Port Status Block

The XMIT port status block is a passive block showing the current port status, Modbus slave activity, ASCII input FIFO, and flow control information that may be used in ladder logic for some applications. Being a passive block, it does not take, release, or control the PLC port in any manner.

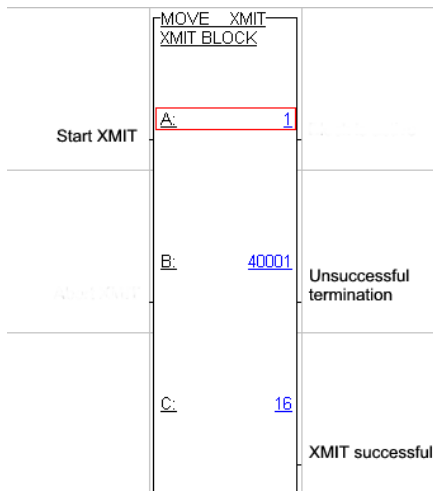

	Inputs	Outputs
Top Node	Begins operation and should remain on until completed or an error has occurred. In order to reset the instruction, this input must be off for at least one scan.	Not used.
Middle Node	Not used.	Output goes ON when an error is detected or an abort has been issued. (see below)
Bottom Node	Not used.	Output goes on when block has completed successfully.
 Warning	Do not modify the address in the middle node of the block or delete it from the program while it is active, as communications will lock up.	

Middle Node Content

The 4x register entered in the middle node is the first in a group of seven (7) contiguous holding registers that comprise the port status display block, as shown below:

Description	Register	No Valid Entries
XMIT Revision Number	4x	Read Only
Fault Status	4x +1	Read Only
Slave login status/port active status	4x +2	Read Only
Slave transaction counter	4x +3	Read Only
Port state	4x +4	Read Only
Input FIFO status bits	4x +5	Read Only
Input FIFO length	4x +6	Read Only

Bottom Node Content

The bottom node must contain a constant equal to (#0007). This is the number of registers used by the XMIT port status instruction.

XMIT Conversion Block

The XMIT conversion block converts data into other usable forms based upon your application needs. The block performs eleven different functions including, but not limited to: ASCII to binary conversion, integer to ASCII conversion, byte swapping, and ASCII string search. The block utilizes 4x source blocks and 4x destination blocks.

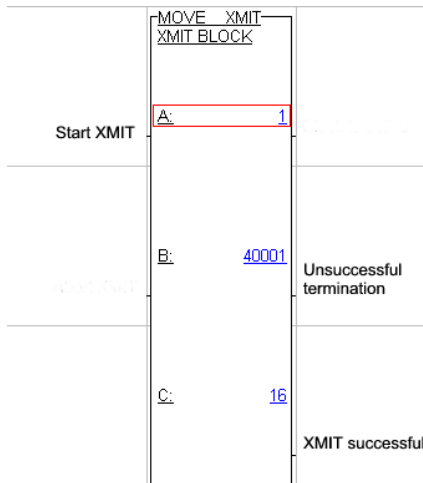

	Inputs	Outputs
Top Node	Begins operation and should remain on until completed or an error has occurred. In order to reset the instruction, this input must be off for at least one scan.	Not used.
Middle Node	Not used.	Output goes ON when an error is detected or an abort has been issued. (see below)
Bottom Node	Not used.	Output goes on when block has completed successfully.

Top Node Content

The top node must contain a constant (#0000) since conversions do not deal with the PLC's port. The loadable version does accept 4x registers in the top node, whereas the built in doesn't.

 Warning	Don't modify the address in the middle node of the XMIT block or delete it from the program while it is active or the function that prevents communications locks up.
--	---

Middle Node Content

The 4x register entered in the middle node is the first in a group of eight contiguous holding registers that comprise the control block, as shown below:

Description	Register	Valid Entries
XMIT Revision Number	4x	Read Only
Fault Status	4x +1	Read Only
Available to User	4x +2	0 (May be used as pointers for instructions like TBLK)
Data Conversion Control Bits	4x +3	Refer to the bit definition table for 4x + 3.
Data Conversion Op-code	4x +4	Refer to the definition table for 4x + 4.
Source Register	4x +5	4x register (begin read at High or Low byte)
Destination Register	4x +6	4x register (begin read at High or Low byte)
ASCII String Character Count	4x +7	Defines the search area

Bottom Node Content

The bottom node must contain a constant equal to (#0008). This is the number of registers used by the XMIT conversion instruction.

17 - Software Loadable Modules

General Description

Software loadable modules are special PLC program instructions available for purchase from Modicon.

PLC Workshop allows the loading and deleting of the modules into/from online or offline memory and the editing of programs that already contain software loadable modules.

PLC Workshop supports the software loadable modules described in this chapter. They are listed below and in the Cross Reference mode, allowing them to be cross referenced by instruction type.

Name	Description
BLKT*	Block to Table
CALL	
CKSM*	Checksum
DMATH	Double Precision Math
DRUM	Drum Sequencer
EARS	
EUCA	Engineering Unit Conversion Alarming
FN10	Custom Loadables
HLTH	984 Health Status
HSBY	Hot Standby
ICMP	Sequencer Input Compare
MAP3	
MATH	Math
MBUS	Modbus
MRTM	Multi-Register Transfer Module
MSTR*	Master Block for Modbus Plus Reg Transfer
PEER	Peer to Peer
PID	Process Control
PID2*	Process Control
TBLK*	Table to Block

* Based on the hardware in use, these can also be considered built-in Enhanced Executive Cartridges. See Enhanced Executive Cartridges for descriptions of these modules.

CALL

Description

The Call instruction activates an immediate or deferred DX function from a library of functions defined by function codes. The Copro (Integrated Control Processor) copies the data and function code into its local memory, processes the data, and copies the results back to controller memory.

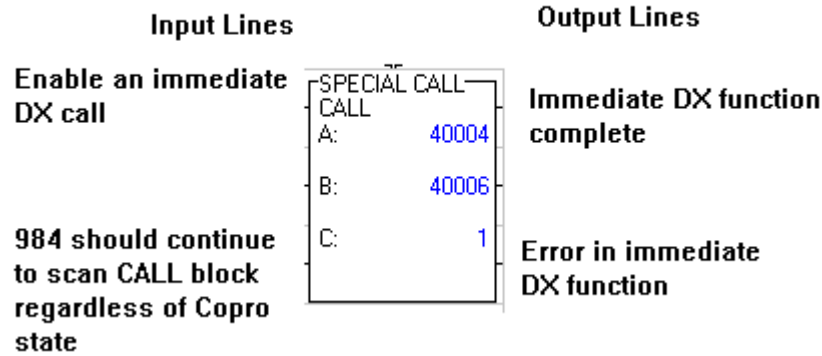

Immediate DX Call

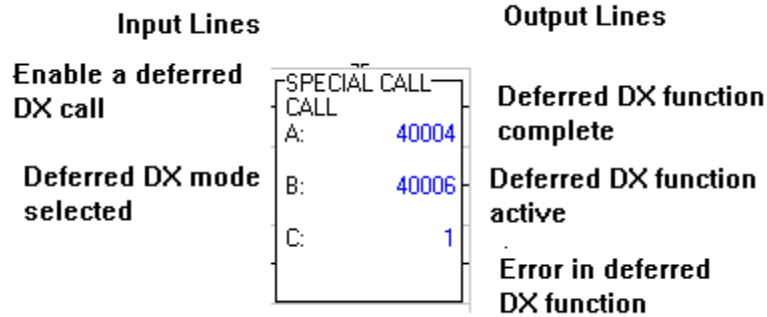

Deferred DX Call

Function Block

Top Node	Displays a constant or 4x holding register containing a function code to be executed. 0 - 999 for user-definable DXs. 500 - 999 system DXs provided by Modicon.
Middle Node	Displays a 4x register that is the first in a block of registers to be passed to the Copro for processing.
Bottom Node	Contains number of registers in the block.

EARS

Description

The EARS loadable function is used in a 984 controller working in conjunction with a man machine interface (MMI) device that runs a special off-line software package. The controller monitors a specified group of events for any changes in state and logs change data into a history table. The data is then removed by the MMI device over Modbus II or Modbus Plus.

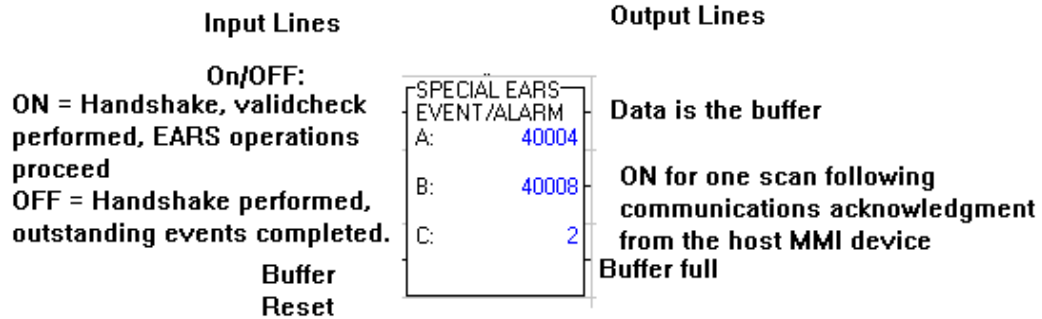

Function Block

Top Node	State table pointer and history table. Contains the first of 64 consecutive 4x registers. The first two of these registers contain values that specify the location and size of the current state table. The remaining two are available for the history table.
Middle Node	Implied registers and buffer table.
Bottom Node	Contains the number of registers used in the buffer. Valid range is from 2 - 100.

EUCA

Description

The Engineering Unit Conversion and Alarming (EUCA) function provides a single ladder logic instruction for configuring the scaling of raw analog input values and checking the values against alarm limits.

Function Block

Top Node	Contains the alarm status of up to four analog inputs. Use a 4XXXX reference.
Middle Node	Contains the control table, which has the raw value, the scaled value, the engineering unit maximum and minimum, the dead band, and the alarm limits. Use a 4XXXX reference.
Bottom Node	Contains a constant from one to four to select which nibble of the status register to use.

FN10

Description

The FN10 custom loadable is used to communicate to the MMC188/40.

To run FN10 in a PLC program, the loadable must be loaded into the PLC Workshop configuration. Install the FN10.DAT file in your \workshop directory. The file is the actual custom loadable.

FN10 must be assigned an opcode that will not conflict with other loadables. When assigning the opcode for FN10 use hex 0x5f.

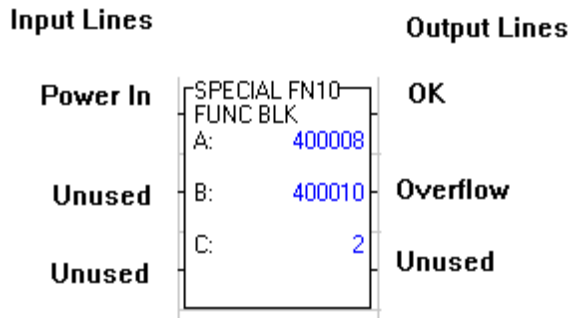

Function Block

Top Node	Control
Middle Node	Displays Accumulator, Word, Parameter 2, Quotient, Parameters, Profile Set, Table, or Output Registers.
Bottom Node	Displays subvention number.
Enable	Enables the function block when power is applied.

INPUT LINES

First Input	Power in
Second Input	Unused, Start/Reset, or Move Block.
Third Input	Unused.

OUTPUT LINES

First Output	Power Out, Active Out, Ok, or Param1>Param2.
Second Output	Unused, Overflow, Carry, Param1=Param2, Done, or Block moved.
Third Output	Unused, Param1<Param2, Not Done, Reset Out, or Ignored Out.

HLTH (984 Health Status)

The 984 Health Status (HLTH) function block extends the functionality of the native STAT instruction by detecting changes in the I/O system and reporting problems only on exception.

FUNCTION BLOCK

Top Node	Contains the history matrix, where the initial state of the I/O system and of the ladder logic checksum is stored. Use a 4XXXX reference.
Middle Node	Contains the status table, where appropriate bits are set based on changes in the I/O system, changes in the logic checksum, existence of disabled coils, the drops' lost communication and retry counters, or determination of negative state of the battery coil, memory protect switch, or S911 board are stored. Use a 4XXXXX reference.
Bottom Node	Contains a constant providing the size of the status table, which is four times the number of drops plus 3.

HSBY

The Hot Standby Loadable (HSBY) is a loadable DX function that manages a Hot Standby control system. This function block must be placed in network 1 of segment 1 in the application logic for both the primary and standby controllers. This function allows you to program a non-transfer area in system state RAM. This area protects a serial group of registers in the standby controller from being modified by the primary controller.

Input Lines

**Execute HSBY
(unconditionally)**

**Enable command
register**

**Enable nontransfer
area of state RAM**

SPECIAL HSBY HOT STDBY	
A:	400012
B:	400014
C:	4

Output Lines

**Hot Standby System
Active**

**A 984 controller cannot
communicate with its R911/S911
module**

FUNCTION BLOCK

Top Node

Contains a 4x holding register used as the HSBY command register.

Middle Node

Contains a 4x register that is the first register in the nontransfer area in state RAM. The first three registers in the nontransfer area are special registers: $4x$ and $4x + 1$ are the reverse transfer registers for passing information from the standby to the primary controller. $4x + 2$ is the HSBY status register.

Bottom Node

Defines the size of the nontransfer area in state RAM. The nontransfer area must contain at least four registers. If you're using a 16-bit processor, the valid range of registers is 4 - 255. If you're using a 24-bit processor, the valid range of registers is 4 - 8000.

MAP3

The MAP3 function block allows the 984 controller to initiate communications with MAP network nodes.

FUNCTION BLOCK

Top Node	Displays the starting register a register containing a function code to be executed. Use a 4XXXXX reference.
Middle Node	Displays a 4x register that is the first in a block of registers to be passed to the Copro for processing. Use a 4XXXXX reference.
Bottom Node	Contains number of registers in the block.

MBUS

The MBUS loadable function is used with the S975 module to initiate a single transaction with another device on the Modbus II network. In MBUS transaction, you are able to read or write discrete or register data.

FUNCTION BLOCK

Top Node	Contains the first of seven 4x registers in the MBUS control block.
Middle Node	Contains the first 4x register in a data block to be transmitted or received in the MBUS transaction.
Bottom Node	Contains the number of words reserved for the data block. This value is entered as a constant. This number does not imply a data transaction length, but it can restrict the maximum allowable number of register or discrete references to be read or written in a transaction.

MRTM (Multi-Register Transfer Module)

The multi-register transfer module (MRTM) function block is used to transfer blocks of holding register from the program table to the command block, a group of output registers. To verify each block transfer, an echo of the data contained in the first holding register is returned to an input register.

FUNCTION BLOCK

Top Node	Displays the first register of the program table. The digit 4 is assumed as the most significant digit.
Middle Node	Displays the first register of the control table. The digit 4 is assumed as the most significant digit.
Bottom Node	Displays the number of register moved from the program table during each transfer. NNN must be a numerical value from 1 to 127.

INPUT LINES

PEER

Description

The PEER loadable function is used with the S975 module to initiate identical message transactions with as many as 16 devices on the ModbusII network at one time. In a PEER transaction, you may only write register data.

Function Block

Top Node	Contains the first of nineteen 4x registers in the PEER control block.
Middle Node	Contains the first 4x register in a data block to be transmitted by the PEER function.
Bottom Node	Contains the number of holding registers to be written starting with the 4x register defined in the middle node. This value is entered as a constant. The range for this value is 1 to 249.

PID

Description

Chose PID to program a PID instruction. Analog loop control provides negative feedback (closed loop) control of a measured process condition, in order to eliminate error conditions. Please refer to the Modicon manual for detailed instructions.

Function Block

Top Node

Points to a bank of 16 consecutive 4XXXX registers that provide the constants and variable data required for the calculation.

Middle Node

Points to five 4XXXX registers (that cannot be used elsewhere in the logic).

Bottom Node

Indicates how often (in tenths of seconds) the PID calculation will be performed. This constant can be from 1 to 255.

18 - Enhanced Executive Cartridge Instructions

Enhanced executive cartridge instructions, listed below, are described in this section. Based on the hardware in use, these instructions could also be considered software loadable modules.

BLKT: Block-to-Table Move

CKSM: Checksum (120, 130, 380, 381, 480, 680, 780)

EMTH: Extended Math

MSTR: Master Block (145, 385, 485, 685, 785)

TBLK: Table-to-Block Move

PID2: PID2 (analog loop control)

Online The program reads whether or not enhanced executive cartridges are present. If they are present, the enhanced instructions are available in the Ladder menu.

Offline You must specify YES for enhanced executive cartridges in the PLC Setup window if you want to program the enhanced instructions. If you select YES, the enhanced instructions are available in the Ladder menu. If you select NO, these instructions are not available.

BLKT (Block-to-Table Move)

Description

The Block-to-Table (BLKT) Move function moves large quantities of holding registers from a source block to a destination block within a table in one scan of memory.

The source block is fixed. However, the BLKT function uses a movable pointer to indicate the destination registers, rather than a fixed destination as in the Block Move (BLKM) function.

NOTE: The BLKT move is a powerful operation. If the logic in your program does not confine the pointer to an appropriate range, all registers in the processor may be corrupted by the source block. Therefore, remember that the pointer register is not protected and can be altered by other logic in the program. Be sure that it never contains a value that specifies a destination outside of the desired range.

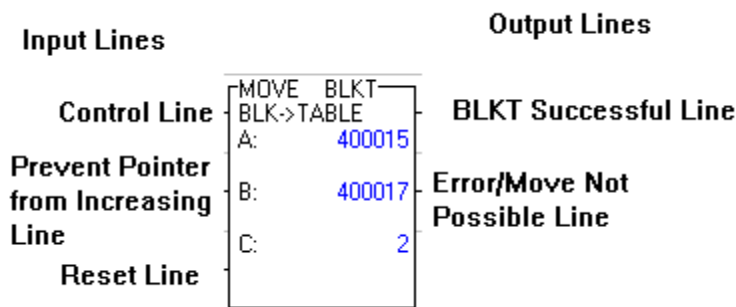

INPUT LINES

Control Line The top input controls the operation. When it is receiving power, the information in the source register is moved into a block in the destination table, as long as the range of destination registers is valid.

Prevent Pointer From Increasing Line The middle input, when receiving power, prevents the pointer from increasing. If this line is energized, the next move will involve the same block of registers as the previous move.

Reset Line The bottom input, when receiving power, resets the pointer to zero. If the top input is also energized, the source is moved to the first block following the pointer register.

OUTPUT LINES

BLKT Successful Line The top output passes power when the top input receives power and the move is successful.

CKSM (CHECKSUM)

Description

The Checksum function block is available with the following processors: A130, A131, A141, 351, 385E/D, 480E, 685E, 785E, 984-380, 381, 480, 680, and 780 processors. It provides the following four types of checksum calculations:

Cyclical redundancy checks (CRC-16) and longitudinal redundancy checks (LRC) are both required for communication over the Modicon Modbus Industrial Communications System.

Straight checksum is the same as LRC except that a two's complement is not performed on the result.

Binary addition checksum provides a straight 16-bit binary addition of registers without a carry.

You select the type of checksum by turning the select lines ON and OFF. For example, to select an LRC checksum, turn the Control line ON and the Select 1 and Select 2 lines OFF.

The figure below illustrates a Checksum function block and its components and shows how to select the checksum type by manipulating the ON/OFF state of the input lines.

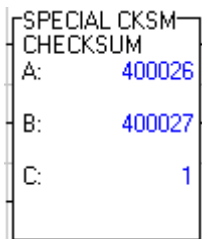

INPUT LINES

Control Line

The control line, when passing power, activates the Checksum. The selected calculation will be performed and the result will be stored in the middle node.

Select 1 and Select 2 Lines

These inputs determine the type of checksum to be performed. Figure 16.3 shows how the CKSM function interprets these inputs.

OUTPUT LINEs

Checksum Successful Line

This output passes power for every scan that the checksum is calculated without any detected errors.

Error Line

This output passes power when the value in the middle node implied register is greater than the length specified in the bottom node, or if the implied register value is zero. This output also turns ON if the table length is beyond the configured range for 4XXXX holding registers.

Input Lines			
Control Lines	Select 1	Select 2	Checksum Types
0			No checksum performed
1	0	0	LRC
1	0	1	Straight checksum
1	1	0	CRC-16
1	1	1	Binary Add checksum

In the above chart, a 1 indicates the input is ON, and a 0 indicates the input is OFF. According to this chart, if you want to select a straight checksum, turn the Control line and the Select 2 line ON, and turn the Select 1 line OFF. To select a Binary Add checksum, turn all three inputs ON.

If the Control line is not ON, the checksum is not performed, regardless of the other two inputs.

FUNCTION BLOCK

Top Node

The top node is the source node, and must be a 4XXXX holding register. This register is the start of the table of registers that will be involved in the checksum calculations. The number of registers in the table is determined by the length value you specify in the bottom node.

Middle Node

The middle node is the destination node and stores the checksum after calculation. It must be a 4XXXX holding register.

The middle node has an implied register ($4XXXX + 1$) that contains the number of registers in the source table that will be involved in the checksum calculation.

Bottom Node

The bottom node contains a numerical value that specifies the length of the block to be involved in the checksum. This constant can range from 1 to 255.

Programming Example

The following programming example illustrates a network with a CKSM instruction.

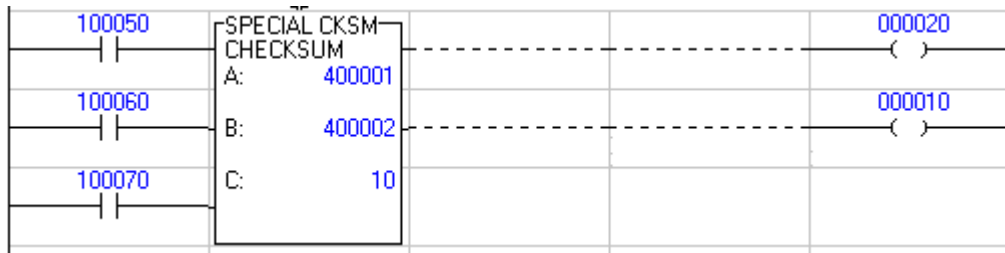

When contact 10050 is turned ON, the checksum is performed. Assuming contacts 10060 and 00070 are both OFF, it is the LRC checksum type. The results of the checksum are placed in holding register 40200, and output coil 00020 is energized.

If the implied register in the middle node (40200) contains a value of 4, the following 4 registers from the source table are involved in the checksum: 40001, 40002, 40003, and 40004.

If the value in the implied register exceeds the length value specified in the bottom node (10), output coil 00010 (Error line) is energized.

EMTH (Extended Math)

Description

The Extended Math (EMTH) function allows you to program 38 different extended math functions. These extended math functions include: double precision integer addition, subtraction, multiplication, and division; integer square root and process square root; logarithm and antilogarithm; and floating point, trigonometric, and other instructions.

Enter the registers to be operated on in the top and middle nodes. Enter the code that corresponds to the type of math function you want to program in the bottom node. See Figure 16.4 for a list of the codes and their definitions.

MATH	EMTH
EXT MATH	
A:	400032
B:	400035
C:	1

Input Lines and Output Lines

The operation of the inputs and outputs depends on the type of extended math function. See Figure 16.5 for a chart showing the types of extended math functions, the associated codes, the types of registers and the inputs and outputs used for each instruction.

Function Block

For all 38 EMTH functions, the nodes operate as follows:

Top Node

The top node requires two registers. For some functions, the second register is not used. However, both must be configured. These can be 3XXXX input or 4XXXX holding registers. You enter the first of the two registers; the second is implied (the register you enter plus 1).

The only valid functions for 3X registers are square root, process square root, logarithm, and antilogarithm. See Table 16.5.

Middle Node

The middle node requires six registers. For some functions, all six might not be used. However, all six registers must be configured. These must be 4XXXX holding registers. You enter the first of the six registers; the subsequent five are implied.

Bottom Node

The bottom node contains a code from 1 to 38, which is entered to specify the math function. See Figure 16.5 for the codes and their descriptions.

Code	Function	Registers	Inputs	Outputs
1	Integer Addition	4X	C1	01,02
2	Integer Subtraction	4X	C1	01,02,03
3	Integer Multiplication	4X	C1	01,02
4	Integer Division	4X	C1,C2	01,02,03
6	Process Sq Root	4X, 3X	C1	01,02
Code	Function	Registers	Inputs	Outputs
8	Antilogarithm	4X, 3X	C1	01,02
9	Integer to FP Conversion	4X	C1	01
10	³ Integer plus FP	4X	C1	01
11	Integer minus FP	4X	C1	01
12	Integer times FP	4X	C1	01
13	Integer divided by FP	4X	C1	01
14	FP minus integer	4X	C1	01
15	FP divided by Integer	4X	C1	01
16	Integer/FP Comparison	4X	C1	01
17	FP to Integer conversion	4X	C1	01,03
18	FP Addition	4X	C1	01
19	FP Subtraction	4X	C1	01
20	FP Multiplication	4X	C1	01
21	FP Division	4X	C1	01
22	FP Comparison	4X	C1	01,02,03
23	FP Square Root	4X	C1	01
24	Change Sign	4X	C1	01
25	Load value of Pi	4X	C1	01
26	Sine in Radians	4X	C1	01
27	Cosine in Radians	4X	C1	01
28	Tangent in	4X	C1	01

	Radians			
29	Arcsine in Radians	4X	C1	01
30	Arccosine in Radians	4X	C1	01
31	Arctangent in Radians	4X	C1	01
32	Radians to Degrees	4X	C1	01
33	Degrees to Radians	4X	C1	01
34	FP Raised to Integer Power	4X	C1	01
35	Exponential Function	4X	C1	01
36	Natural Log	4X	C1	01
37	Common Log	4X	C1	01
38	Report Errors	4X	C1	01,02

In this chart, FP = Floating Point

NOTE: For further information, see Modicon's Enhanced Executive Cartridge User's Guide for detailed explanations of the 38 extended math functions.

Programming Example

The following programming example illustrates the double precision addition EMTH function (code 1).

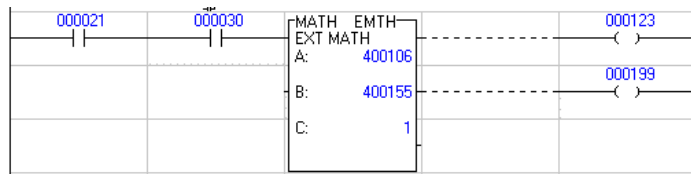

When contacts 00021 and 00030 (the top input) are turned ON, the EMTH function is performed. The contents of holding registers 40106 and 40107 are added to the contents of 40155 and 40156. If an overflow condition occurs, 40157 is set to 1. The result of the addition operation is stored in holding registers 40158 and 40159.

The top output, coil 00123, is energized if the operation is successful and the top input is ON. The middle output, coil 00199, is energized if an error condition exists and the top input is ON.

In the top node, 40106 and 40107 hold the first operand.

In the middle node:

40155 and 40156 hold the second operand.

40157 indicates an overflow condition, if set to 1.

40158 and 40159 hold the result of the addition operation.

40160 is implied but not actually used for the double precision addition function.

In the bottom node, code number 1 is entered, indicating a double precision addition operation.

MSTR

Description

The Master Block instruction is available with the A145, 145, AT/MC984, 385E/D, 455, 485E, 685E, 785E, 785L, 984-385, 485, and 685 processors. MSTR is used to program communications on the MODBUS Plus network. Up to 4 MSTR instructions requiring a data master transaction path can be active (enabled) within a program at the same time.

Figure 16.6 illustrates an MSTR function block and its components.

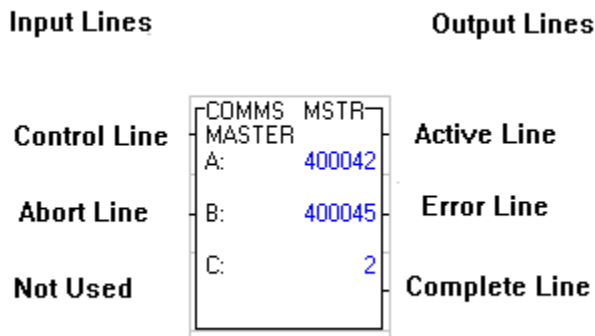

INPUT LINES

Control Line When ON, allows the MSTR instruction to be executed (assuming the Abort line is OFF). The enable line must remain ON until the communication is completed or an error is returned. If enable is OFF when the MSTR is processed, all outputs of the MSTR will be turned OFF.

Abort Line When ON, will terminate an MSTR operation that is active or soon to be active. The enable line must be ON for the Abort line to have any effect. When the Abort function is executed, the abort error code is written to the error status register, the Abort output is turned ON, and the Complete and Active outputs are turned OFF.

OUTPUT LINES

Active Line The Active line is ON while the MSTR function is in the process of executing. It remains on until the function is complete. The Active line will not go ON for functions that require only one scan.

Error Line The Error line turns ON when the MSTR function is not completed successfully. An error code is written to the error status register.

Complete Line The Complete line turns ON when the MSTR function is completed successfully. For single scan functions, the Complete line is turned ON in the same scan. For multiple scan functions, the Complete line is turned ON when all processing for the operation is finished. When the Complete line goes ON, a 0 is written to the error status register.

CONTROL BLOCK Use the DX Zoom function to view and edit Control Block contents.

To access DX Zoom, click on block and select the View / DX Zoom menu item or press [Ctrl-D].

The size of the Control Block is operation dependent.

DATA AREA In a Write operation, the Data Area is defined as the area where data is coming from.

In a Read operation, the Data Area is defined as the area where data is going.

LENGTH Length refers to the amount of data to be read / written.

PID2

Description

The analog loop control function provides negative feedback (closed loop) control of a measured process condition. The process variable (PV) is compared to the setpoint (SP). The difference between the two is called the error (E).

This error is fed into a control calculation. The calculation yields a control value that is used to adjust the control variable so that the process variable equals the setpoint.

Figure 16.7 shows the PID2 function block and its components.

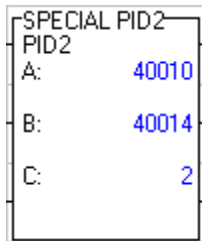

Input Lines and Output Lines

Please see Modicon's Enhanced Executive Cartridge User's Guide for a complete explanation of the references entered in the top and middle nodes, the input and output lines, and how these references and lines operate in the calculation. PID2 is a very complicated function that involves extensive ladder logic. The Modicon manual also contains detailed instructions for programming the PID2 function.

Function Block

Top Node

The top node is the source node and points to a bank of 21 consecutive 4XXXX holding registers. These registers provide the variable data and constants required to solve the PID2 calculation.

Middle Node

The middle node is the destination node and points to a bank of 9 4XXXX holding registers. These registers must not be used elsewhere in the logic.

Bottom Node

The bottom node contains a numerical value that specifies how often the PID2 calculation should be performed. This value indicates tenths of seconds. For example, enter 255 if you want the calculation to be performed every 25.5 seconds.

TBLK (Table-to-Block Move)

Description

The Table-to-Block (TBLK) Move function moves large quantities of holding registers from a source block within a table to a destination block in one scan of memory. The destination block is fixed. However, the TBLK function uses a movable pointer to indicate the source registers, rather than a fixed source as in the Block Move (BLKM) function.

Figure 16.8 illustrates the TBLK function block and its components. An explanation of each of the components follows.

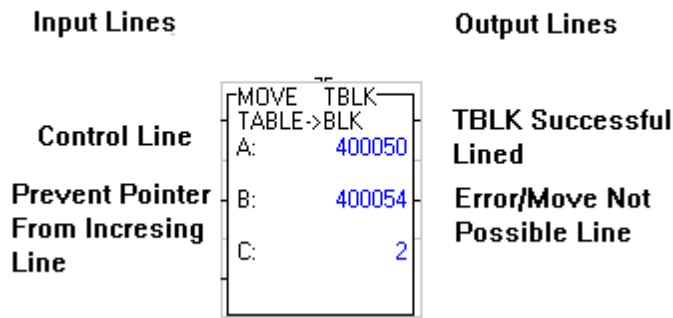

INPUT LINES

Control Line The top input controls the operation. When it is receiving power, a block of registers from the source table is moved into the destination block, as long as the range of registers is valid.

Prevent Pointer From Increasing Line The middle input, when receiving power, prevents the pointer from increasing. If this line is energized, the next move will involve the same block of registers as the previous move.

OUTPUT LINES

Reset Line The bottom input, when receiving power, resets the pointer to zero. If the top input is also energized, the first block in the source table is moved to the destination block.

Error/Move Not Possible Line The middle output passes power when the top input receives power and an error condition exists. For example, if the pointer register indicates a source block that is outside the configured range, the Error line is energized.

TBLK Successful Line The top output passes power when the top input receives power and the move is successful.

**FUNCTION
BLOCK**

Top Node The top node is the source node, and must be a 4XXXX holding register. This register is the start of the block of registers to be involved in the move. The number of registers in the block is determined by the length you specify in the bottom node.

Middle Node The middle node is the destination node and contains the pointer register. It must be a 4XXXX holding register. The destination block starts with the register immediately following the pointer register (4XXXX + 1).

The value within the pointer register indicates which block in the source table will be moved. For example, if the pointer register holds a value of 0, the first block in the source table will be moved. If the pointer register holds a 1, the second block in the source will be moved. And if the pointer register holds a value of 2, the third block in the source will be moved, etc.

The registers within the blocks are determined by the top node value and the bottom node value. For example, if the top node contains register 40011 and the block length specified in the bottom node is 5, registers 40011 through 40015 comprise the first block, and will be moved when the pointer value equals 0. Registers 40016 through 40020 comprise the second block, and will be moved when the pointer value equals 1. Registers 40021 through 40025 comprise the third block, and will be moved when the pointer value equals 2, etc.

The pointer value will automatically increment by one as each move is performed, unless the Prevent Pointer from Increasing Line or the Reset line is energized.

Since the pointer register is not protected, it can be changed by other logic in the program.

Bottom Node The bottom node contains a numerical value that specifies the length of the block to be moved and the length of the destination block. This constant can range from 1 to 100.

For example, if the source register is 40010 and the length is 10, registers 40010 through 40019 will be moved into the ten registers of the destination block.

Programming Example

The following programming example illustrates a network with a TBLK function.

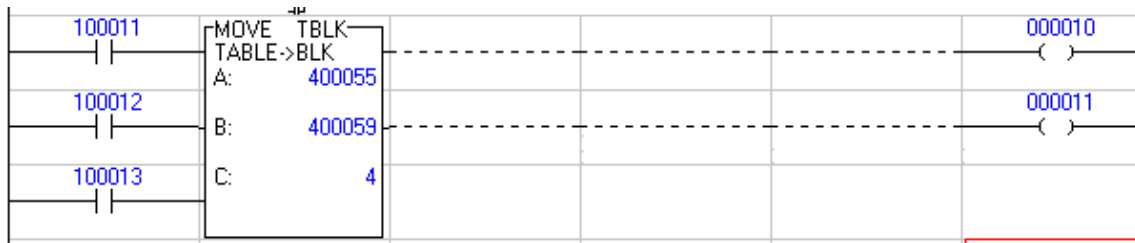

When input 10014 is energized, the top input receives power and the contents of registers 40001 through 40010 are moved into registers 40201 through 40210, assuming the pointer value is 0. The data is moved all at once. The pointer value increases to 1. Output coil 00033 is energized if the move is successful. Output 00055 (Error line) remains OFF.

On the next scan, if the top input is still receiving power, the contents of registers 40011 through 40020 are moved into registers 40201 through 40210, and the pointer value increases to 2.

If the pointer value increases so that it points to a range that is beyond configured quantities, output coil 00055 (Error line) is energized and the pointer register holds its value. Also, whenever the top input loses power, the TBLK operation stops and the pointer register holds its value.

If contact 10010 is energized (Prevent Pointer from Increasing Line), the pointer value remains the same and the move involves the same source block, for example, registers 40011 through 40020. As long as the pointer register holds the same value, each successive move will involve the same block of source registers.

If contact 00017 (Reset line) is energized, the pointer value is reset to 0, and the source block to be moved is again registers 40001 through 40010 (first block).

19 - Subroutines

JSR (Jump To Subroutine)

Description

The Jump to Subroutine function directs the logic to a specified subroutine, located in the last segment. The JSR function can appear anywhere in the logic, even within another subroutine. It is termed “nesting” when a subroutine occurs within another subroutine, and “looping” when a subroutine calls itself. The 984-80/85 processors allow up to 100 levels of nesting.

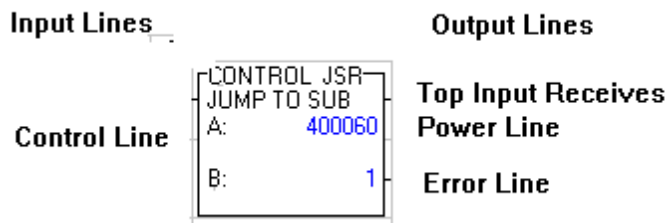

INPUT LINES

Control Line The top input controls the operation. When this input transitions from OFF to ON the JSR function is performed and logic jumps to the target subroutine specified in the top node.

Top Input Receives Power Line This output passes power when the Control line is energized, after logic returns from the subroutine. The Top Input Receives Power Line is energized if the Control Line is energized, regardless of whether or not a target subroutine exists. However, if the target subroutine does exist, there might be a delay before the Top Input Receives Power Line is energized, depending on how long it takes to search for, execute, and return from the subroutine.

OUTPUT LINES

Error Line This output is energized if the JSR is not successful. The JSR is not successful if the target subroutine does not exist, or if the maximum number of subroutine nesting levels (100) has been exceeded. In all other cases, this output is OFF.

FUNCTION BLOCK

Top Node

The top node is the source node. It can either be a constant or a 4XXXX holding register reference with a value between 1 and 255, inclusive. This node directs logic to the subroutine specified by the top node value. The JSR top node value should correspond to the LAB value of the subroutine being jumped to.

Bottom Node

The bottom node contains the size value. This size value must be a constant of 1.

NOTE: The JSR is not successful if the target subroutine does not exist, or if the maximum number of nesting levels (100) has been exceeded. Although up to 100 levels of nesting are allowed, it is recommended that no more than three levels of nesting be programmed. More than three levels of nesting makes programs difficult to understand, troubleshoot, and support.

Programming Example

The following programming example illustrates a network with a JSR function.

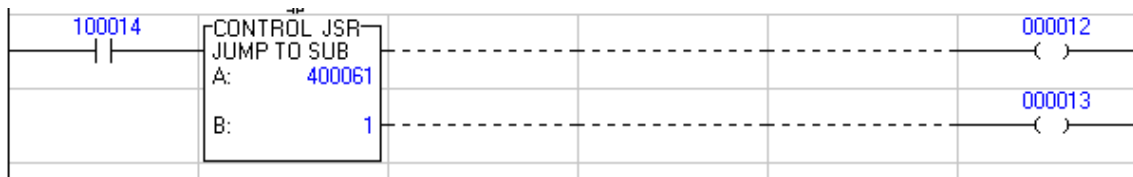

When input 10011 transitions from OFF to ON, the JSR function block receives power and logic is directed to the subroutine specified by the top node value. The top output passes power and coil 00012 is energized, after logic returns from the subroutine. If the JSR is not successful, the bottom output passes power and energizes coil 00013.

LAB (Label Subroutine)

Description

The Label function is used to label the starting point of a subroutine. It also functions as a default return if a Return function has not been programmed into the preceding subroutine network. The LAB function must be programmed in the first row of the first column of a network in the last segment.

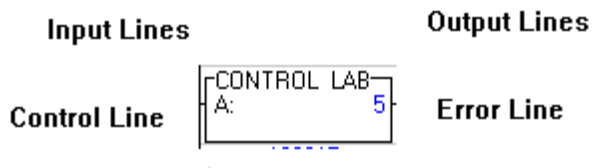

INPUT LINES

Control Line

Because the LAB function must be programmed in row 1, column 1, the Control line is directly connected to the Power line. Therefore, the Control line is always energized. When a JSR function calls the subroutine marked by the LAB, logic starts scanning that subroutine.

OUTPUT LINES

Error Line

The only output for the LAB function is the error output. This is energized if the LAB is encountered by the processor when a JSR has not been executed (i.e. the subroutine stack is empty). In all other cases this output is OFF.

FUNCTION BLOCK

Function Block

The LAB function block occupies one node in a network. It contains the LAB symbol and a constant between 1 and 255, inclusive. You can program up to 255 different subroutines. Each LAB must have a different number. The LAB number should correspond to the JSR number that specifies which subroutine is being jumped to.

RET (Return From Subroutine)

Description

The Return from Subroutine function returns logic to the node immediately after the most recently executed JSR instruction. The Return function only has effect if it is programmed in a network in the last segment.

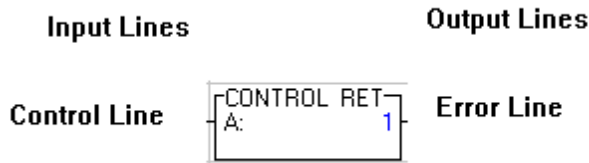

INPUT LINES

Control Line The top and only input, when receiving power, causes the Return function to be performed. The Return function returns logic from the subroutine to the node immediately after the most recently executed JSR.

OUTPUT LINES

Error Line The only output for the RET function is the error output. This is energized if the RET has been programmed without a subroutine. In all other cases this output is OFF.

FUNCTION BLOCK

Function Block The RET function occupies one node in a network. It consists of the RET symbol and a size value. This size value must be a constant of one.

NOTE: If a subroutine does not contain a RET function, the next LAB function or the end of logic, whichever comes first, acts as a default return.

20 - Miscellaneous Instructions

Instructions for the 351/455 Processors

Description

The information in this section describes the following instructions available for use with 351/455 processors:

Sequencers	Allow independent control for repetitive operations.
CONV	Converts BCD to binary or binary to BCD in 484 mode.
RTTI	Moves the register value to an input table in 484 mode.
RTTO	Moves the register value to an output/holding table in 484 mode.
TTR	Moves the table value to a series of registers in 484 mode.

The 484 Compatibility Mode

The 484 Compatibility Mode allows sequencers, ADD, MUL, and DIV functions to operate differently depending upon whether the mode is ON or OFF. If this mode is ON it has the following effects on the four functions. Figure 18.1 summarizes its effects.

The sequencers are enabled.

An overflow occurs if the result of an ADD function is greater than 999.

The high and low order result of a MUL is separated differently.

The remainder of the DIV function is discarded.

Using Implied References

The references used in the CONV, RTTI, RTTO, and TTR instruction have been modified. These compatibility references are referred to as implied references. They have been changed to be compatible with other 984-processor conventions. Figure 18.2 provides the old 484 functions, their new compatibility counterparts, and how the implied references are applied. The RTTI and RTTO functions operate as the 484 RTT function.

Old 484 Function	New Compat. Function	Implied Pointer	Implied Source	Implied Destination
CONV	CONV	N/A	Disc. Inputs or N/A*	Disc. Outputs or Holding Register **
RTT	RTTI	Input Reg.	N/A	N/A
	RTTO	Output Reg.	N/A	N/A
TTR	TTR	N/A	N/A	Holding Register

* When using a constant, the source is implied as a discrete input. When using a holding register as the source, nothing is implied (N/A).

** When using a constant as the source, the destination is implied as holding register. When using a holding register as the source, the destination is an implied discrete output.

Each implied reference is equal to a 3-digit number. Figure 15.38 shows the relationship.

Implied References	Actual Content
0xxxx (Discrete Output)	3-Digit Number
1xxxx (Discrete Input)	3-Digit Number
3xxxx (Input Register)	3-Digit Number
4xxxx (Holding Register)	3-Digit Number

NOTE: Implied Reference Coils are marked as used. However, you cannot search for these coils as you would for regular coils.

Sequencers

The sequencers allow independent control for repetitive operations. Sequencers are assigned to eight specific holding registers (40051-40058), each register corresponding to thirty-two relays. For example, register 40051 corresponds to 00513-00544 relays, and register 40052 corresponds to 00545-00576 relays. These specific registers can be used in any functions such as counters, timers, or any arithmetic operations. Refer to Figure 18.4.

Sequencer Number	484 Sequencer Relays	484 Sequencer Registers	984 Sequencer Relays	984 Sequencer Register
1	2101-2132	4051	00513-00544	40051
2	2201-2232	4052	00545-00576	40052
3	2301-2332	4053	00577-00608	40053
4	2401-2432	4054	00609-00640	40054
5	2501-2532	4055	00641-00672	40055
6	2601-2632	4056	00673-00704	40056
7	2701-2732	4057	00705-00736	40057
8	2801-2832	4058	00737-00768	40058

NOTE: When the 484 Compatibility Mode is set, it allocates these relays as sequencer relays. When not set, these relays act as normally open relays.

NOTE: When in the 484 mode, the sequencer coils are not mapped to external field devices. When putting a number in register 40051 to turn on coil 513, only the contacts of the coil will activate. The coil itself will not turn ON or OFF.

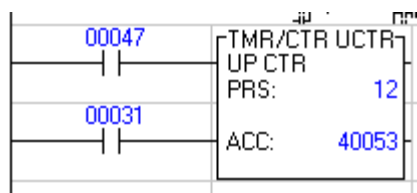

In Figure 18.5, the counter has a preset of 12 and stores its current count in register 40053. Every time input 10047 is energized, the value in register 40053 is incremented by one. This is equivalent to moving the stepping switch one position. This example is a 12-step sequencer; 32 steps are available in all sequencers. The counter limits this circuit to 12 steps, since that is the preset. Whenever coil 0003 is energized, the counter is reset to zero and the stepping switch goes back to home (no reference energized) regardless of the current count.

CONV

The CONV instruction converts either holding registers to discrete outputs or discrete inputs to holding registers. The CONV can remain binary or changed to BCD. CONV is a two-mode function block.

Use a constant to represent a reference number. The Search by reference number online function cannot determine the actual reference number used.

Input Lines

Control In

Conversion Type

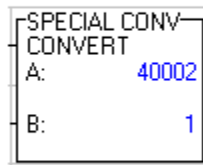

Output Lines

CONV done

INPUT LINES

Control In Line

When the top node is powered, the CONV function is performed on every scan. Use a transitional contact to get a single CONV operation.

RTTI

The RTTI instruction copies the bit pattern of any register or 16 discretes to a specific input register located within a table. Use a constant to represent a reference number. The system can accommodate one transfer per scan. RTTI is a two-node function block.

Use a constant to represent a reference number. The Search by Reference Number online function cannot determine the actual reference number used.

NOTE: The pointer value has a legal range of 801-832, or 1-254. If outside, the function is NOT performed and the Illegal Pointer value output rail is activated.

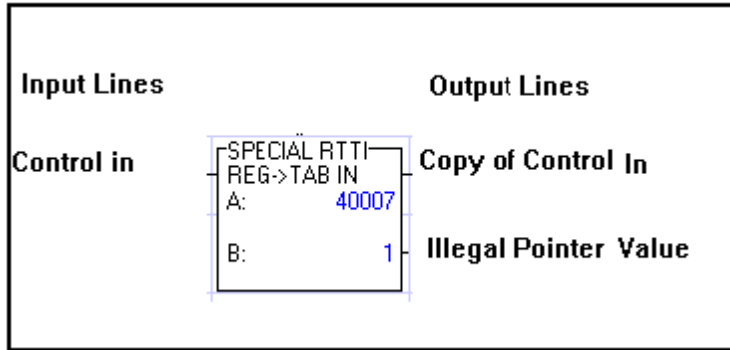

RTTO

The RTTO instruction copies the bit pattern of any register to a specific holding register located within a table. Use a constant to represent a reference number. The system can accommodate one transfer per scan. RTTO is a two-node function block.

Use a constant to represent a reference number. The Search by Reference Number online function cannot determine the actual reference number used.

NOTE: The pointer value has a legal range of 801-832, or 1-254. If outside, the function is NOT performed and the Illegal Pointer Value output rail is activated.

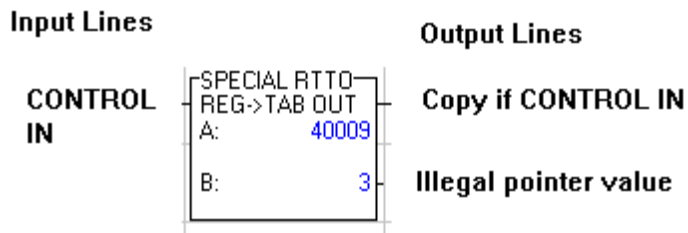

FUNCTION BLOCK

Top Node Source can be either an input register (3xxxx), or a holding register (4xxxx).

Bottom Node Pointer is a constant that implies a holding register (4xxxx).

Contains the symbol RTTO and a number specifying Pointer must be a constant indicating a holding register (4xxxx). The contents of the (4xxxx) points to the destination table, with a valid range of 1 to 254, or 801 to 832 that corresponds to (40001 to 40254), or (30001 to 30032) respectively.

INPUT LINES

Control In When the top node is powered, RTTO is performed on every scan. Use a transitional contact to get a single RTTO operation.

OUTPUT LINES

Copy of Control In Passes power when the top input is powered.

Illegal Pointer Value Passes power when the Pointer value is outside the allowed range.

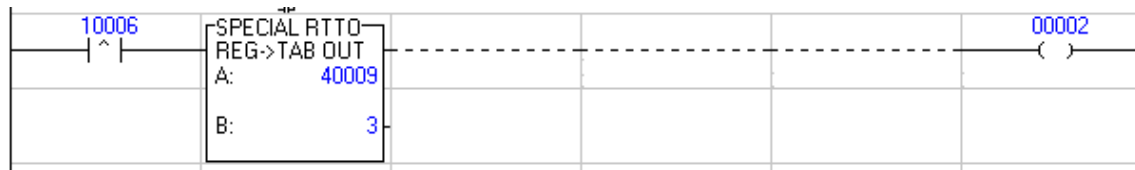
Example

In Figure 18.12, the first transition of 10047 copies 30012 to 40011. The Pointer value remains the same; it does not increment. On the next scan, if the new value read from 40010 is 7, then the contents of 30012 is copied to 40007. In order to store to successive locations, you need additional user logic to increment the pointer each time the RTTO is executed.

TTR

General Description

The TTR instruction copies the bit pattern of any register located within a table to a specific holding register. Use a constant to represent a reference number. The system can accommodate one transfer per scan. TTR is a two-node function block.

Use a constant to represent a reference number. The Search by Reference Number online function cannot determine the actual reference number used.

NOTE: The pointer value has a legal range of 801-832, or 1-254. If outside, the function is NOT performed and the Illegal Pointer Value output rail is activated.

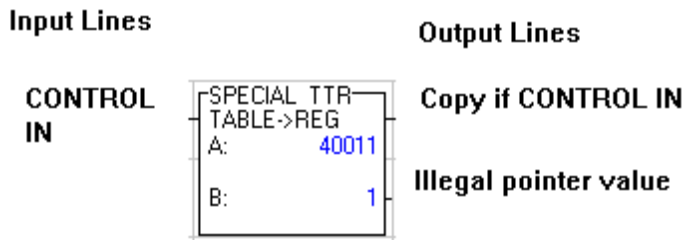

INPUT LINES

Control In Line When the top node is powered, TTR is performed on every scan. Use a transitional contact to get a single TTR operation.

OUTPUT LINES

Copy of Control In Passes power when the top input is powered.

Illegal Pointer Value Passes power when the Pointer value is outside the allowed range.

FUNCTION BLOCK

Pointer The Top Node, Pointer, can be either an input register (3xxxx), or a holding register (4xxxx).

Contains a number specifying a Pointer register. It points to the destination table, with a valid range of 1 to 254, or 801 to 832 that corresponds to (40001 to 40254), or (30001 to 30032) respectively.

16-Bit Signed and Unsigned Math Functions

Description

A group of three-node instructions are available to support 16-bit math functions. The structure of these instructions closely resembles the familiar BCD-based ADD, SUB, MUL, and DIV blocks available in all models of 984 PLCs.

These instructions can do both signed and unsigned 16-bit math calculations. Two additional instructions are available to convert to sign floating point values for use in EMTH operations. Their nodal structure and their block input/output requirements are described on the following pages.

AD16	Signed/unsigned 16-bit addition
SU16	Signed/unsigned 16-bit subtraction
MU16	Signed/unsigned 16-bit multiplication
DV16	Signed/unsigned 16-bit division
TEST	Compares the magnitude of two signed/unsigned 16-bit integers
ITOF	Signed/unsigned integer-to-FP conversion
FTOI	FP-to-signed/unsigned integer conversion

AD16 (16-Bit Addition)

Description

AD16 is a three-node instruction that adds the value in the top node to the value in the middle node and posts the sum in the holding register in the bottom node.

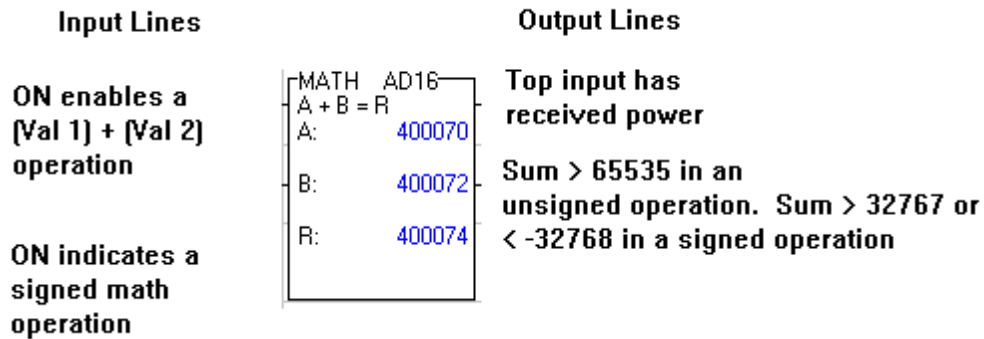

Function Block

The top and middle nodes may contain either:

A constant value up to 65,535

A 3x input register

A 4x holding register

The bottom node contains the 4x holding register where the sum of the 16-bit addition will be stored.

Output Lines

The bottom output is the overflow flag. It turns ON when the sum is larger or smaller than the instruction is designed to calculate.

SU16 (16-Bit Subtraction)

SU16 is a three-node instruction that subtracts the value in the middle node from the value in the top node and posts the difference in the holding register in the bottom node.

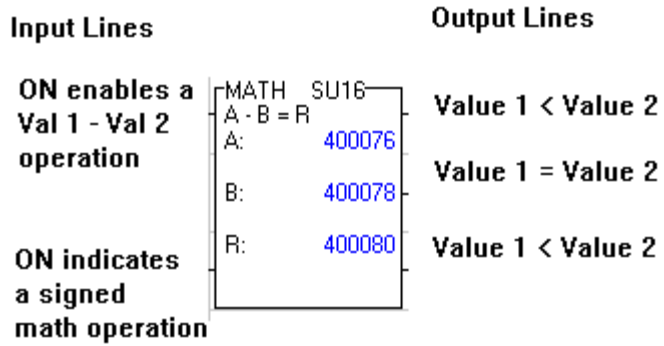
**Function Block**

The top and middle nodes may contain either:

A constant value up to 65,535

A 3x input register

A 4x holding register

The bottom node contains the 4x holding register where the difference of the 16-bit subtraction will be stored.

MU16 (16-Bit Multiplication)

Description

MU16 is a three-node instruction that multiplies the values in the top and middle nodes and posts the product in two contiguous holding registers. The first register is specified in the bottom node.

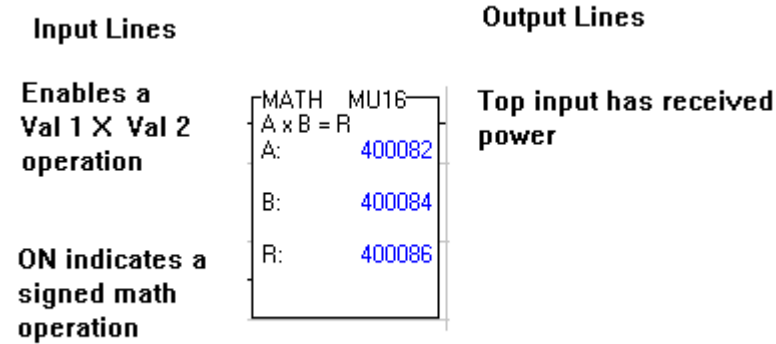

Function Block

The top and middle nodes may contain either:

- A constant value up to 65,535
- A 3x input register
- A 4x holding register

The bottom node contains a 4x holding register where the high-order half of the product is stored. The low-order half of the product is stored in the next contiguous holding register (4x+1) after the register in the bottom node.

DV16 (16-Bit Division)

Description

DV16 is a three-node instruction that divides the value in the top node by the value in the middle node and posts the quotient and remainder in two contiguous holding registers. The first of which is specified in the bottom node.

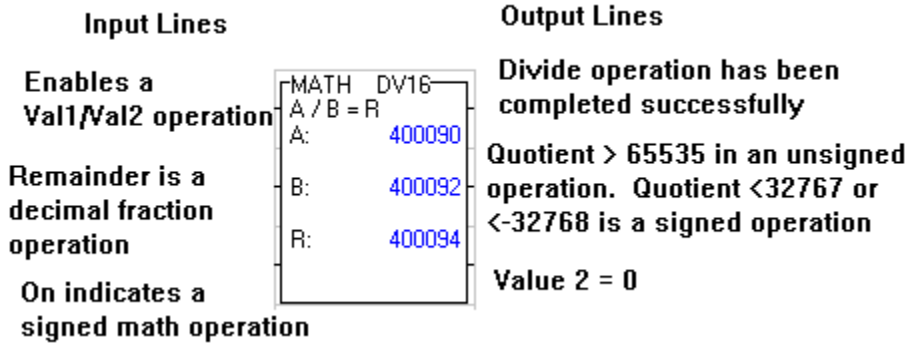

Function Block

The top and middle nodes may contain either:

A constant value up to 65,535

A 3x input register

A 4x holding register

The bottom node contains a 4x holding register where the quotient is stored. The remainder of the divide operation is stored in the next contiguous holding register (4x+1) after the register given in the bottom node.

Output Lines

The middle output is the overflow flag. It turns ON when the quotient is larger or smaller than the instruction is designed to calculate.

TEST (16-Bit Magnitude Comparison)

Description

TEST is a three-node instruction that compares the magnitudes of the values in the top and middle nodes and describes the relationship via the states of the block outputs.

Input Lines

Compares the magnitudes of Values 1 and Values 2

ON indicates a signed math operation

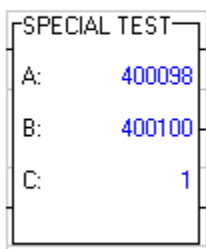

Output Lines

Value 1 > Value 2

Value 1 = Value 2

Value 1 < Value 2

Function Block

The top and middle nodes may contain either:

A constant value up to 65,535

A 3x input register

A 4x holding register

The bottom node contains a constant value of 1.

I_TO_F (Signed/Unsigned Integer-to-Floating Point Conversion)

Description

I_TO_F is a three-node instruction that converts signed or unsigned integer value in the top node to a floating point (FP) value and posts that FP value in two contiguous holding registers. The first register is specified in the middle node.

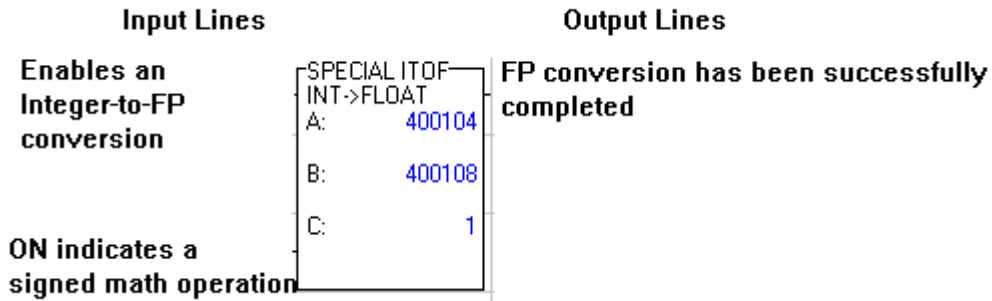

Function Block

The top and middle nodes may contain either:

A constant value up to 65,535

A 3x input register

A 4x holding register

The middle node is the first of two contiguous 4x holding registers where the converted floating point value is stored.

The bottom node contains a constant value of 1.

FTOI (Floating Point-to-Signed/Unsigned Integer Conversion)

Description

FTOI is a three-node instruction that converts the floating point (FP) value in the top node to a signed or unsigned integer value and posts that integer value in the middle node.

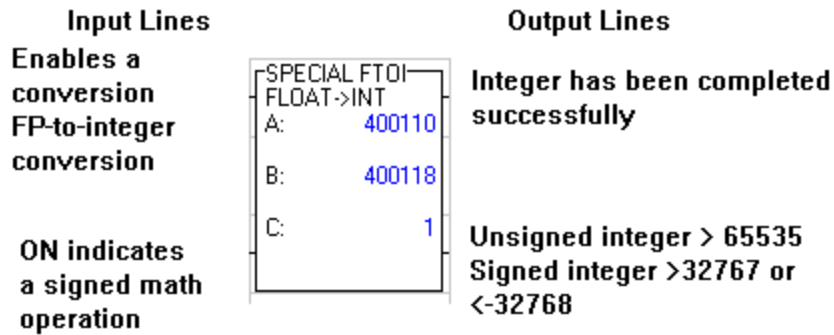

Function Block

The top is the first of two contiguous 4x holding register where the floating point value is stored.

The middle node is a 4x holding register where the converted integer value is stored.

The bottom node contains a constant value of 1.

Output Lines

The bottom output is the overflow flag. It turns ON when the converted integer value is larger or smaller than the instruction is designed to calculate.

PCFL

Processor Control Function Library

Description

The Processor Control Function Library (PCFL) is a single 3-node DX block in ladder logic. Like EMTH, this DX can be used to reference an entire library of functions. PCFL is intended for continuous process control dealing with analog values. Functions in PCFL are divided into three major categories:

- Advanced calculations
- Signal processing
- Regulatory control

The following dialog displays the 23 PCFL variants. When a PCFL instruction is used, the specific variant is described at the top of the instruction in ladder.

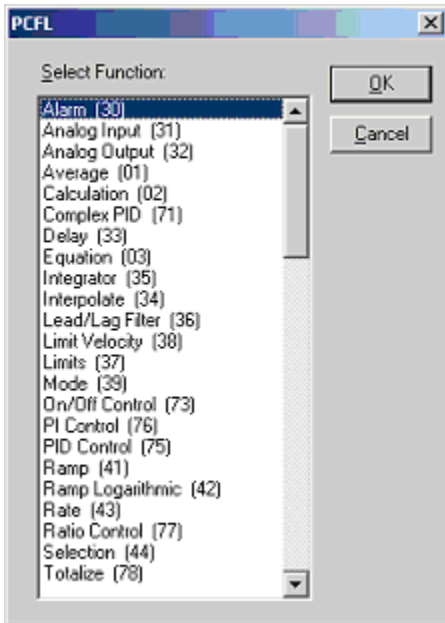

Input Lines

Output Lines

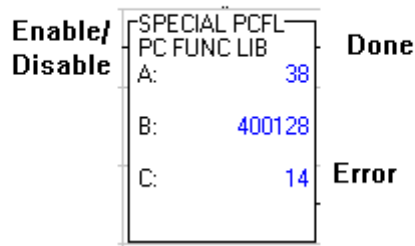

Input and Output Lines

The PCFL block accepts one input (top = enable/disable) and produces one of two outputs:

Top = DONE

Bottom = ERROR

Function Block

The body of the function block includes the following:

- FUNC** Enter the code representing the name of PCFL library function. It is displayed in the top node. The codes are summarized in Summary of PCFL Functions.
- 4XXXX** Enter the first holding register for parameters for PCFL.
- LEN** Enter the length of the registers table to process for PCFL. This is identified in Table 18.23 Summary of PCFL Instructions, the # Registers column. This value is used to calculate the registers used for the table and printout. If you change this value the Registers Used Table may be incorrect.

Summary of PCFL Functions

The table below summarizes the Process Control functions that have been programmed for PCFL block. An asterisk after the function name denotes that the function is time-dependent. The translated function code is also listed followed by the number for registers needed by the module and a short description. When programming a PCFL, these functions are selected from a pick list. Once in the pick list, pressing the first letter of the function is a quick way to select that function. (Ex: pressing 'D' will place the cursor on DELAY.)

Function	Code	# Registers	Description
Advanced Calculations			
AVE	01	24	Average of set of weighted inputs (up to 4).
CALC	02	14	Calculation block for pre-set programmed formulas.
EQN	03	64 max.	Postfix notation calculator for user programmed equations. Includes four internal variables that can be set up from other sections of logic. The length depends upon the user equation, but is limited to 64 registers (can be up to 255). See Chapter 16 for a Zoom Screen example. The formula can be entered

directly from the Zoom Screen. The total number of registers used in your equation is displayed in the Zoom Screen. To optimize the number of registers used by the controller, change the bottom node (LEN) of the function to equal the Registers Used value in the Zoom Screen.

Signal Processing

ALARM	30	16	Central alarm blocks LL, L, H, HH are available for Deviation and Process Variable.
AIN	31	14	Interface for input modules. Converts input to scaled engineering units, including a provision for process SQRT.
AOUT	32	9	Interface for calculated signals with output modules by converting an output signal to a value between 0 and 4095.
DELAY *	33	32	Pure delay for use with time-delay compensation.
LKUP	34	39	A look-up table for up to eight points.
INTEG *	35	16	Integrate an input at a given interval
LLAG *	36	20	First order lead/lag filter.
LIMIT	37	10	Limiter for process variable, LL, L, H, HH.
LIMV *	38	14	Velocity limiter for process variable changes for L,H.
MODE	39	8	Lets you put an input in either manual or auto mode.
RAMP *	41	14	Ramp generator used for set point filtering. Ramps to a given set point at a constant rate.
RMPLN *	42	16	Logarithmic ramp generator used for set point filtering. Ramps to a given set point, approximately 2/3 closer to the set point for each time constant.

RATE * 43 14 Derivative over specified time period. For rate calculations.

SELECT 44 14 High/Low/Average selector.

Regulatory Control

ONOFF 73 14 Two-position deadband. You can specify either ON or OFF.

PID * 75 44 ISA non-interacting PID.

*** time-dependent**

DIOH

Description

The distributed I/O health instruction (DIOH) lets you retrieve health data from a specified group of drops on the distributed I/O network. It accesses the DIO health status table, where health data for modules in up to 189 distributed drops is stored.

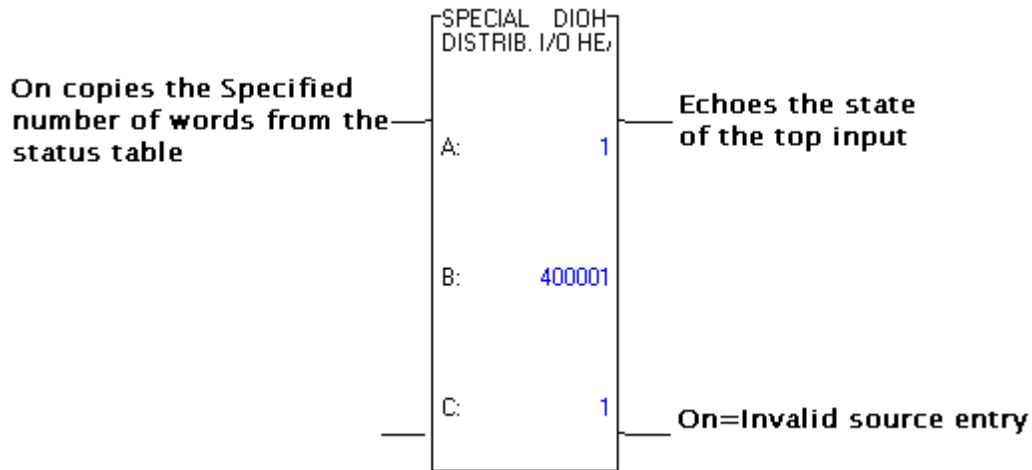

Function Block

Top Node

The source value is a 4 digit constant xxyy where
 xx = the decimal value in the range 00 .. 16, indicating the slot number of the DIO processor
 yy = is the decimal value in the range 1..64, indicating the drop number

Middle Node

The 4x register is the first holding register in the destination table.

Bottom Node

The integer value entered specified the length or the number of 4x registers in the destination table.

Instructions for the Micro PLCs

CTIF

Description

The CTIF instruction is a configuration/operation tool for Modicon Micro PLCs that contain hardware interrupts (all models except the 110CPU311 models). The actual counter/timer and interrupts are located in the PLC hardware, and the CTIF instruction is what is used to set up this hardware.

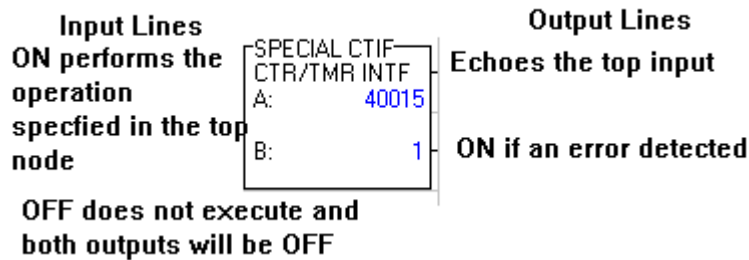

FUNCTION BLOCK

- | | |
|--------------------|---|
| Top Node | First word in the CTIF parameter block, with an implied size of four. |
| Bottom Node | Drop number where the operation is performed. Valid values are an integer constant ranging from 1 to 5. |

SCIF (Sequential Control Interface)

Description

The Sequential Control Interface (SCIF) instruction combines two subfunctions - Drum and ICMP. Drum mode is used to map a predefined bit pattern to the outputs on the Modicon Micro PLC in a sequential, step-by-step fashion. ICMP (input compare) mode is used to match inputs coming from the field devices with a predefined table of patterns for each step of the drum.

Using drum and ICMP together allows the programmer to fire outputs and compare the status of the inputs against a predefined status. If a mismatch occurs, the process is halted.

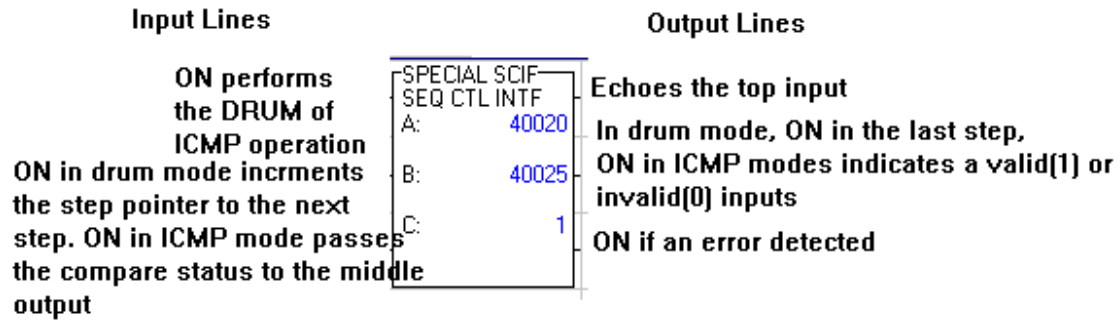

FUNCTION BLOCK

- | | |
|--------------------|--|
| Top Node | The step pointer |
| Middle Node | The first register in the data step table; the first six registers in the table are reserved. |
| Bottom Node | The number of application-specific step data registers in the step data table; the total number of registers in the table is K + 6. K is an integer in the range of 1 through 255. |

T1MS

Description

Use the T1MS (millisecond timer) instruction to time events or create delays in an application. T1MS increments at intervals of 1 ms.

FUNCTION BLOCK

Top Node Timer preset. K is an integer in the range 1 through 999

Middle Node Accumulated time

Bottom Node Always set to a constant value of one

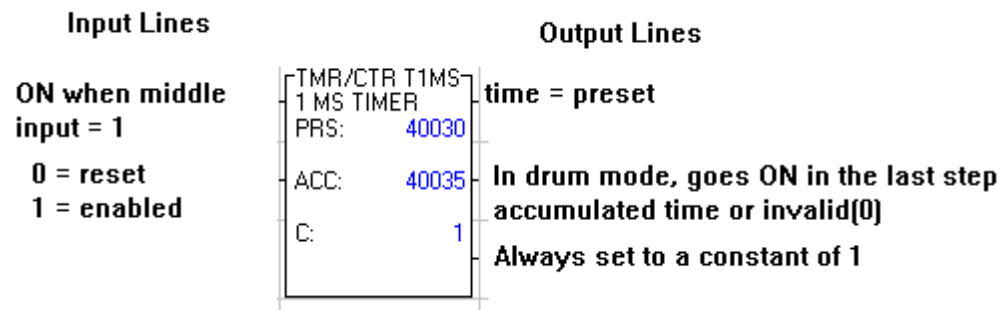

CONV

Available only on the 984-351 and 984-455

The Convert block is one of four 484-replacement instructions. It is used to convert discrete data to a holding register or holding register data to discrete data.

The conversion can be either binary-to-binary, BCD-to-binary (discrete to register) or binary-to-BCD (register to discrete). This block uses 12 bits in and 12 bits out, but if the conversion is straight binary-to-binary, bits 11 and 12 are forced off.

In converting discretetes to a holding register, the source is specified as a constant, which implies a 1xxxx, and the destination is specified as a constant, which implies a 4xxxx (for example, 00049 implies 40049).

In converting a register to output discretetes, the source is specified as a holding register (4xxxx) and the destination is specified as a constant, which implies a 0xxxx. For example, 00032 implies 12 coils starting with 00032.

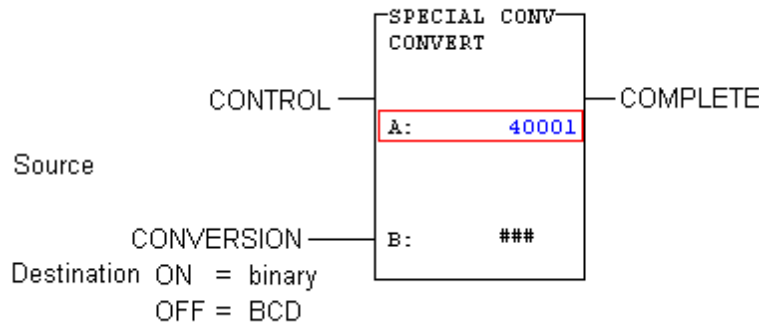

Warning

Care should be taken when converting register data to discretetes as coils may inadvertently be activated.

RTTI

The Register to Input Table block is one of four 484-replacement instructions. It copies the contents of an input register or a holding register to another input or holding register. This destination register is pointed to by the input register implied by the constant in the bottom node. Only one such operation can be accommodated by the system in each scan.

The pointer is a 3xxxx implied by a constant (i.e. 00018 -> 30018) whose contents indicate the destination. A value of 1 to 254 indicates a holding register (40001 - 40254) and a value of 801 to 832 indicates an input register (30001 - 30032). If the value is outside this range, the operation is not performed and the ERROR rail is powered. Note the pointer's value is NOT incremented automatically.

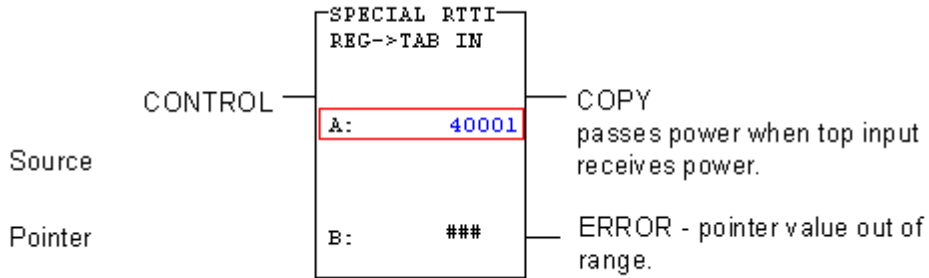

RTTO

The Register to Output Table block is one of four 484-replacement instructions. It copies the contents of an input register or a holding register to another input or holding register. This destination register is pointed to by the holding register implied by the constant in the bottom node. Only one such operation can be accommodated by the system in each scan.

The pointer is a 4xxxx implied by a constant (i.e. 00018 -> 40018) whose contents indicate the destination. A value of 1 to 254 indicates a holding register (40001 - 40254) and a value of 801 to 832 indicates an input register (30001 - 30032). If the value is outside this range, the operation is not performed and the ERROR rail is powered. Note that the pointer's value is NOT incremented automatically.

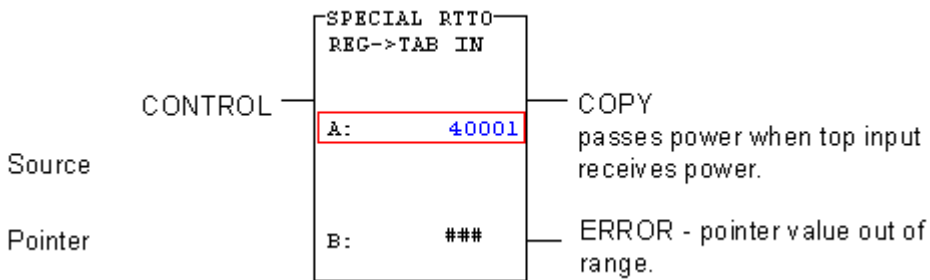

TTR

Available only on the 984-351 and 984-455.

The Table to Register block is one of four 484-replacement instructions.

It copies the contents of a source (input or holding) register to a holding register implied by the constant in the bottom node. This source register is pointed to by the input or holding register specified in the top node.

Only one such operation can be accommodated by the system in each scan.

The pointer is a 3xxxx or 4xxxx whose contents indicate the source. A value of 1 to 254 indicates a holding register (40001 - 40254) and a value of 801 to 832 indicates an input register (30001 - 30032). If the value is outside this range, the operation is not performed and the ERROR rail is powered.

NOTE: The pointer's value is NOT incremented automatically.

The destination is a holding register implied by the constant in the bottom node (for example, 00018 -> 40018).

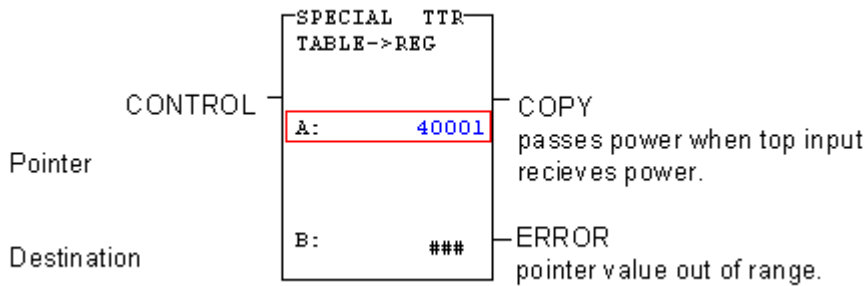

COMM

Available only on the Micro 311,411,512 and 612 controllers.

The ASCII Communications Function (COMM) block is used to transmit/receive ASCII data (in the form of a single ASCII character, 1 to 4 integers or 1 to 4 hexadecimal numbers) to or from the simple ASCII port.

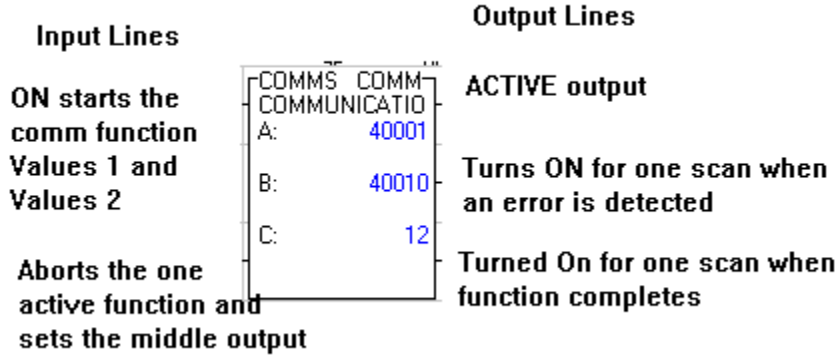

- 4xxxx+ 0 = Operation Code
- 4xxxx+ 1 = Error Status
- 4xxxx+ 2 = Number of data fields provided/expected
- 4xxxx+ 3 = Number of data fields processed
- 4xxxx+ 4 = Reserved
- 4xxxx+ 5 = Port Number (1 for local, 2 for child #1, 3 for child #2, etc.)
- 4xxxx+ 6 = Reserved
- 4xxxx+ 7 = Reserved
- 4xxxx+ 8 = Reserved
- 4xxxx+ 9 = Active Status Timer

FUNCTION BLOCK

- Top Node** Beginning of the control block
- Middle Node** Write function source or Read function destination
- Bottom Node** Size of the source/destination table. Valid values are an integer constant in the range of 1 through 255.

COMM Operation Codes

Code	Operation
1000	Flush Input Buffer in Read Operation
1001	Flush Specified Input Bytes in Read Operation
1002	Control/Monitor RTS, CTS, DSR
1010	Read ASCII Character - NO CR/LF
1020	Read ASCII Character - CR/LF
1031 - 1034	Read 1 to 4 Integers (I1, I2, I3, I4) - NO CR/LF
1041 - 1044	Read 1 to 4 Integers (I1, I2, I3, I4) - CR/LF
1051 - 1054	Read 1 to 4 Hexadecimals (H1, H2, H3, H4) - NO CR/LF
1061 - 1064	Read 1 to 4 Hexadecimals (H1, H2, H3, H4) - CR/LF
1110	Write ASCII Character - NO CR/LF
1120	Write ASCII Character - CR/LF
1131 - 1134	Write 1 to 4 Integers (I1, I2, I3, I4) - NO CR/LF
1141 - 1144	Write 1 to 4 Integers (I1, I2, I3, I4) - CR/LF
1151 - 1154	Write 1 to 4 Hexadecimals (H1, H2, H3, H4) - NO CR/LF
1161 - 1164	Write 1 to 4 Hexadecimals (H1, H2, H3, H4) - CR/LF

CTIF

The Interrupt/Timer/Counter function is only available on Micro 311, 411, 512 and 612 controllers. The CTIF block is used by a parent PLC to access child functions over an I/O expansion bus.

The Parent PLC's function block will complete in the same scan. If multiple blocks exist, the last one executed will be used.

4xxxx+0 = Error/Operation Type Bit #15 Bit #16

0 0 Set Mode

0 1 Get Mode

4xxxx+1 = Control Register Bit #1 Bit #2

0 0 No Change

0 1 Select Counter Mode

1 0 Select Timer Mode

1 1 No Change

4xxxx+2 = Status Register

4xxxx+3 = Current Count Value of Timer/Counter

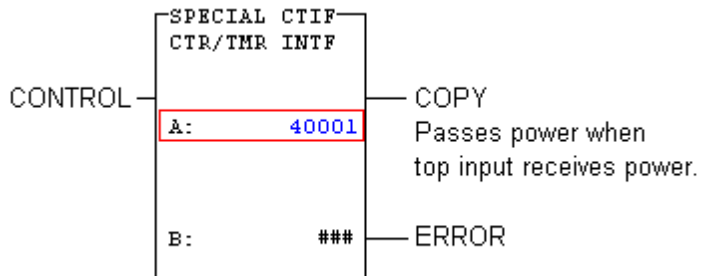

NOTE: B: has a value of 1 to 5 that designates the drop number.

MATH

Each MATH function operates on the contents of the top node registers and places a result in the middle node registers.

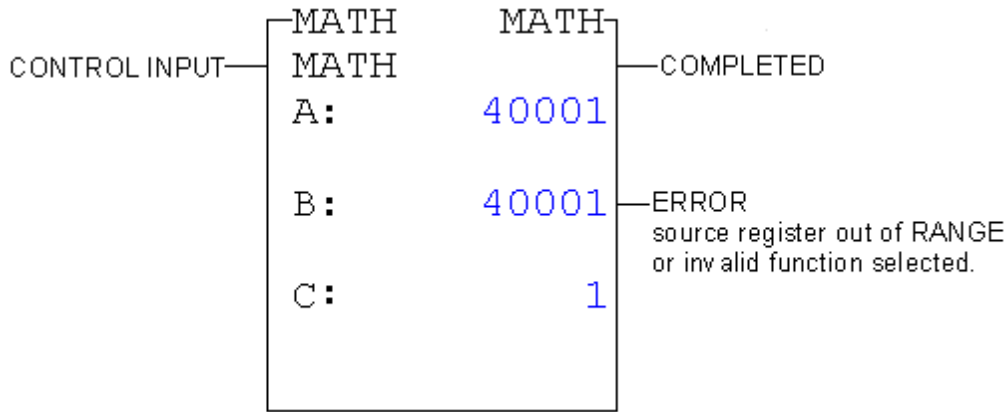

For example, the normal square root uses registers A: (3/4xxxx and 3/4xxxx+1) as an 8 digit operand and stores the result in B: (4yyyy and 4yyyy+1.) The result storage format is XXXX.XX00 where there are 2 places of precision following an implied decimal point.

Math performs the function indicated by the bottom node (see table).

C:	Function Register	Operand Registers (A:)	Range	Result Register's (B:)	Range
1	Normal	3/4xxxx 3/4xxxx+1	8 digits	4yyyy, 4yyyy+1	xxxx.xx00
2	Process	3/4xxxx	4 digits	4yyyy, 4yyyy+1	xxxx.xx00
3	Log (X)	3/4xxxx 3/4xxxx+1	8 digits	4yyyy	1 – 7.999
4	Antilog (X)	3/4xxxx	1 – 7.999	4yyyy, 4yyyy+1	8 digits

In general the higher 4 digits of an 8 digit number are stored in the lower register (4yyyy rather than 4yyyy+1).

NOTE: Log(X) & Anti-Log(X) are both base 10 functions. Process Square Root multiplies the Square Root of the contents of 3/4xxxx by Square Root(4095) to normalize it for measurements taken with 12 bit A/D converters.

DMTH

Double Precision Math performs a double precision addition, subtraction, multiplication, or division (set by bottom node). Double precision uses 2 registers appended together to form one OPERAND. Each DMTH instruction operates on the same 2 OPERANDS:

OP1 = 4xxxx, 4xxxx + 1 (A: top node)

OP2 = 4yyyy, 4yyyy + 1 (B: middle node)

As shown below, results, flags, and remainders are stored in the registers following OP2. Registers not used by the chosen math function may be used for other purposes.

NOTE: For numbers spread over more than one register, the least significant 4 digits are stored in the highest holding register.

Z Double Precision Functions Result Registers

1 Add (OP1) + (OP2) (4yyyy + 3, 4yyyy + 4)

2 Subtract (OP1) - (OP2) (4yyyy + 2, 4yyyy + 3)

3 Multiply (OP1) * (OP2) (4yyyy + 2, 4yyyy + 3)(4yyyy + 4, 4yyyy + 5)

4 Divide (OP1) \ (OP2) (4yyyy + 2, 4yyyy + 3) quotient(4yyyy + 4, 4yyyy + 5) remainder

NOTE: The Subtract function uses the outputs to indicate the result of comparison between OPERANDS OP1 and OP2. These outputs and those for add, multiply and divide are listed in the table below.

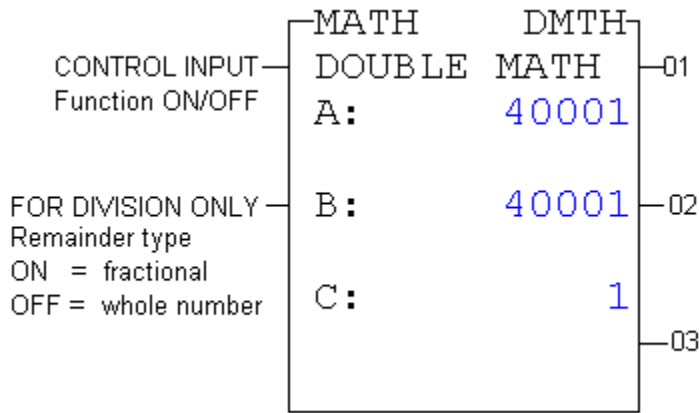

0?	ADD / MULIPLY / DIVIDE	SUBTRACT
01	FUNCTION SUCCESSFUL	OP1 > OP2
02	ERROR - operand out range	OP1 = OP2
03	FOR DIVISION ONLY - divide by zero attempted	OP1 < OP2

DRUM

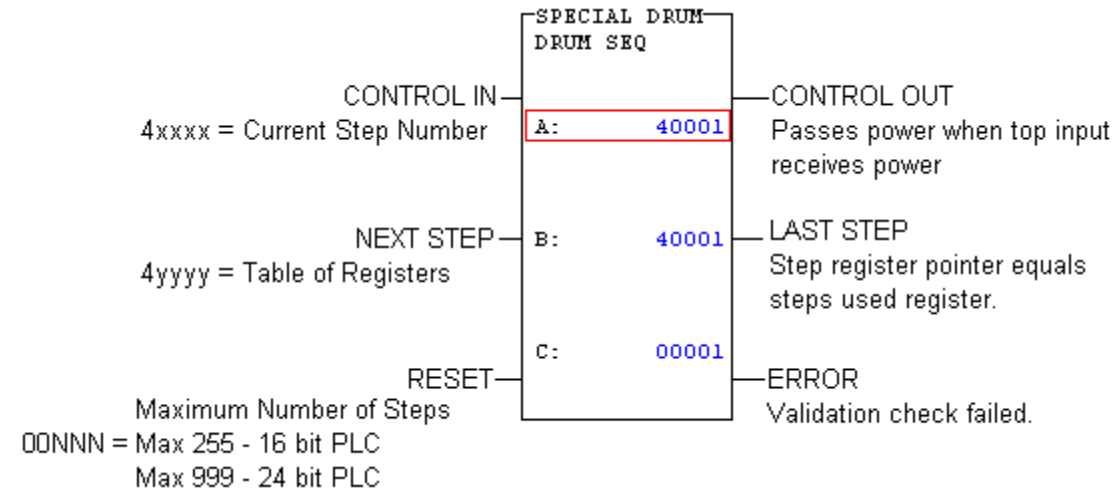

NOTE: Ensure the middle node of only one drum of a set of cascaded drums is connected or multiple counts occur.

The Drum block operates on a table of registers containing 16-bit data values for each step in a sequence. As the pointer is increased, the data for the step is moved from the table to a second register. When the top node receives power, a validation check is performed and if it passes, data moves and mask operations are performed. When the middle node receives power, the step pointer is incremented to the next step before step data is moved. If the pointer is on the last step then no action is taken. When the bottom node receives power the step pointer is cleared.

DRUM - Registers

Drums can be cascaded to form drums wider than 16 bits. Drums with the same current step register (4xxxx) are considered to be cascaded. An output mask allows the user to mask bits of register data before writing to coils.

Masked Output Data(4yyyy) Contains the result of Step Data (4yyyy+1) masked with the Output Mask (4yyyy+2).

Current Step Data(4yyyy + 1) Contains data from the current step pointed to by the current step register 4xxxx.

Output Mask(4yyyy + 2) Contains the mask to be applied to the data for each sequencer step.

Machine ID Number(4yyyy + 3) Used to identify DRUMS belonging to a specific machine configuration. (must be 1-9999).

Profile ID Number(4yyyy + 4) Used to identify what data is currently loaded into the sequencer (must be 1-9999).

Steps Used(4yyyy + 5) Contains the number of steps for the DRUM. (1-255 16-bit PLC or 1-999 24 bit PLC).

Step Data Table(4yyyy + 6) Table of data beginning at 4yyyy+6 (length is set by the bottom node of the DRUM block).

ID numbers out of range causes all cascaded drums to not operate.

ID

Available only on Quantum v2.xx and VME 424/x controllers.

The Interrupt Disable block is used to mask timer and I/O interrupts. When the top input is active, the system will mask any response to any interrupts generated by the timers or I/O modules.

A - Specifies the interrupt type to be masked. May be a constant 1 to 3:

1. All interrupts masked
2. I/O module interrupts masked
3. Timer interrupts masked

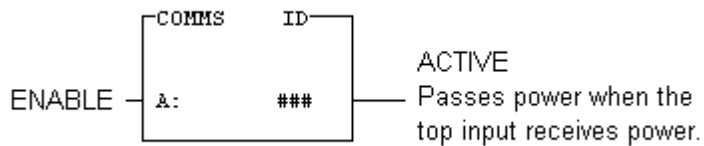

IE

Available only on Quantum v2.xx and VME 424/x controllers.

The Interrupt Enable block is used to unmask timer and I/O interrupts. When the top input is active, the system will unmask and respond to any interrupts missed from the timers or I/O modules.

A: - Specifies the interrupt type to be unmasked. May be a constant 1 to 3:

- 1 - All interrupts unmasked
- 2 - I/O module interrupts unmasked
- 3 - Timer interrupts unmasked

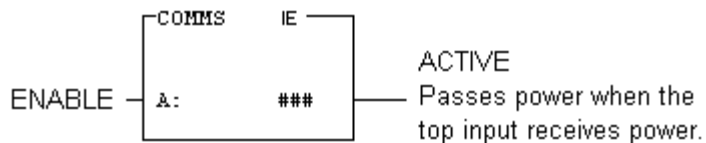

ITMR

Available only on Quantum v2.xx controllers.

The Interval Timer Interrupt block is used to provide interrupts to asynchronous user logic. This two-node block allows the user to create a timer that is capable of interrupting the normal scan cycle to execute the specified logic. The resolution is 1 ms. The interval can be programmed in 1 second, or 1,10, or 100 ms intervals. Up to 16 ITMR blocks can appear in logic.

A: 4xxxx Function Control/Status Register

A: 4xxxx + 1 Timer interrupt Interval

A: 4xxxx + 2 Subroutine Label number (1-1023). This follows the same rules as the JSR block.

B: The timer number. Must be unique for each ITMR block or an error will result.

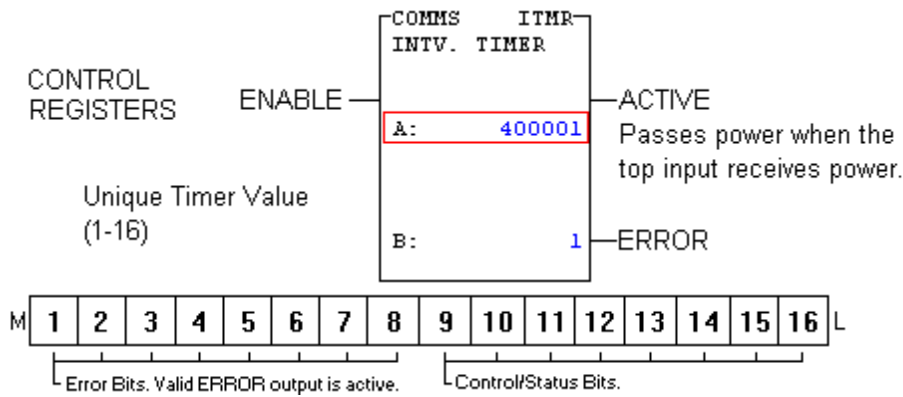

Bits

- 1 Execution delayed due to interrupt mask 12, 13 00 – 1 ms counting
- 2 Invalid block in Sub 01 – 10 ms counting
- 3 Not Used 10 – 100 ms counting
- 4 Time = 0 11 – 1 sec counting
- 5 Mask Interrupt Overrun 14 0 – PLC stop resets counter
- 6 Execution Overrun 1 – PLC stop holds counter
- 7 No Label of Invalid Label 15 0 – Enable low resets counter
- 8 Timer number used in previous network 1 – Enable low holds counter
- 9, 10 Reserved 16 0 – Function disabled
- 11 Not used 1 – Function enabled

IMIO

Available only on Quantum v2.xx controllers.

The Immediate I/O block is used to access specified modules from within logic, as opposed to regular processing, which occurs at the beginning (inputs) or end (outputs) of logic solving for the segment.

A: 4x Module slot in Local drop. High byte = Rack; Low byte = Slot.

A: 4x +1 Error Status:

- 2001: Invalid operation type
- 2002: Invalid slot (module not defined)
- 2003: Module not bi-directional
- F001: Module not in healthy state

B: This is the function to perform:

- 1 – Input: Transfer data from module to state RAM
- 2 – Output: Transfer data from state RAM to module
- 3 – Bi_Dir: Allows both Input and Output for bi-directional modules

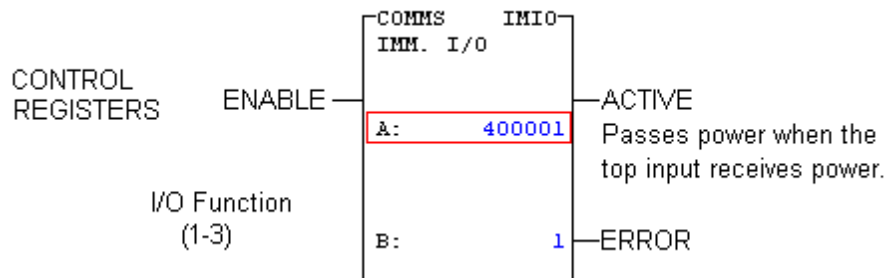

BMDI

Available only on Quantum v2.xx controllers.

The BMDI block is used to do a block move between normal logic and an interrupt subroutine. It allows the user to mask both timer and I/O interrupts for the move and then unmask them.

 Warning	If you have used the ID function prior to BMDI, those interrupts are re-enabled once the BMDI is completed.
--	---

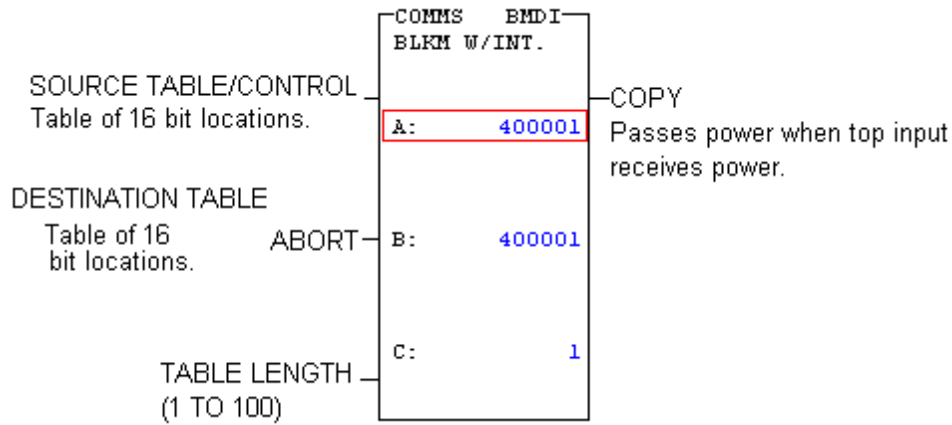

VMER

Available only on the Quantum VME-424/X controller.

The VME Read block allows the user to read data from devices on the VME bus.

A: The first of five control 4x registers.

A: 4xxxxVME Address modifier code (39, 3A, 3D, 3E, 29 or 2D)

4xxxx+1 to 4xxxx+4: The VME Control block.

B: A pointer to the first destination 4x register.

C: A constant specifying the number of destination registers to which data is transferred. This can be from 1 to 255.

If Byte Swap is active, the high byte is exchanged with the low byte of a word after it is read from the VME bus. If Word Swap is enabled, the upper word is exchanged with the lower word of a double after it is read. An error will occur if both inputs are enabled at once.

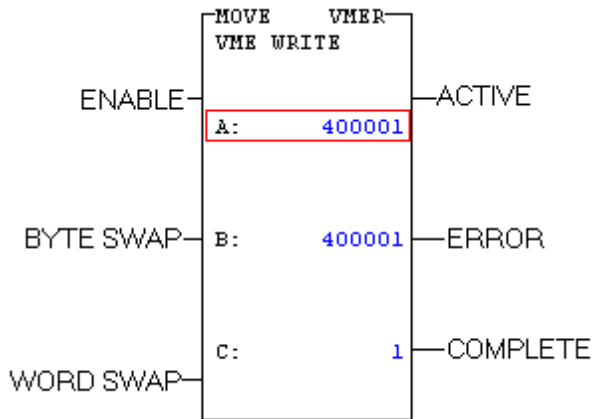

ACTIVE: Passes power when the top input receives power.

ERROR: Passes power when an error occurs.

COMPLETE: Passes power when the read complete.

VMEW

Available only on the Quantum VME-424/X controller.

The VME Write block allows the user to write data to devices on the VME bus.

A: The first of five control registers.

High byte: VME Address modifier code (39, 3A, 3D, 3E, 29 or 2D).

Low byte: Data bus size.

4xxxx+1 to 4xxxx+4: The VME Control block.

B: A pointer to the first source register 3x/4x.

C: A constant specifying the number of data source registers to be transferred to the VME bus. (1-255 is valid)

If BYTE SWAP is active, the high byte is exchanged with the low byte of a word before it is written to the VME bus. If WORD SWAP is active, the upper word is exchanged with the lower word of a double before it is written. An error will occur if both inputs are enabled at once.

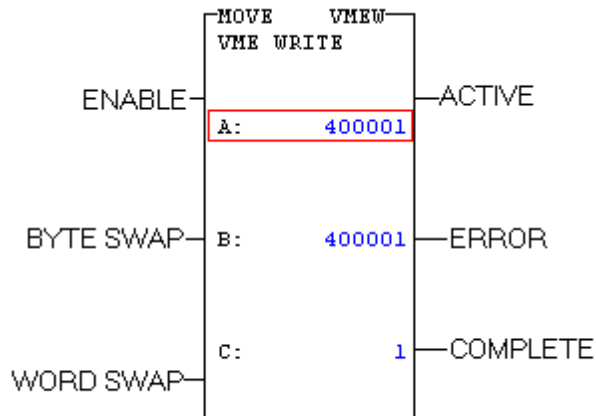

ACTIVE: Passes power when the top input receives power.

ERROR: Passes power when an error occurs.

COMPLETE: Passes power when the write is complete.

SWAP

Available only on the Quantum VME-424/X controller.

The SWAP block allows the user to issue one of three different swap commands:

1. Swap high and low bits of a 16-bit word.
2. Swap high and low words of a 32-bit double word.
3. Swap (reverse) bits within a register's low byte.

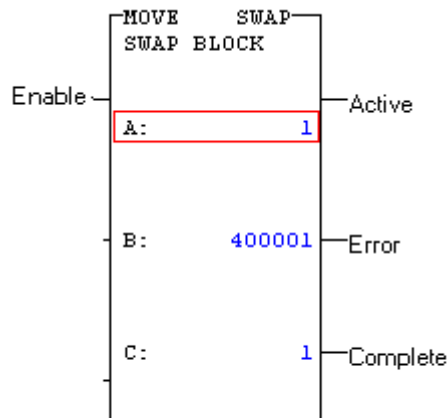

A: Contains a constant from 1 to 3, specifying what type of swap to perform (see the above list)

B: Contains the register 3x/4x on which the swap is to be performed

C: Contains a constant that indicates how many registers are to be swapped, starting with the source register

ACTIVE: Passes power when the top input receives power

ERROR: Passes power when an error occurs

COMPLETE: Passes power when complete

IMOD

IMOD Interrupt Module Vectors:

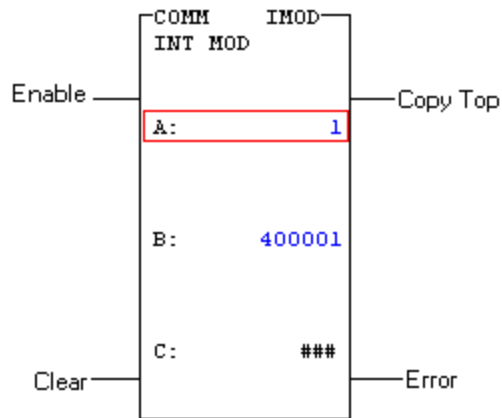

Provides Interrupt vectoring to subroutines from a module in the given slot of the PLC backplane, (e.g. 140 HLI 340 00).

TOP NODE (number 1-16)

Slot number in PLC backplane that has the interrupt module. PLC gives error if slot is same as PLC slot.

(Note that Modsoft does not limit this entry).

MIDDLE NODE (4xxxx)

The first 4xxxx control register contains the function

Status: Bit 16 (lsb) 1=enabled; bits 15-9=unused;

bit 8=Error, slot nbr used in another network;

bit 7=Error, max nbr interrupts defined in module;

(see module info for defining interrupts).

bit 6=Error, intp. lost due to edit user logic;

bit 5=Error, module unhealthy

bit 4=Error, Interrupt lost because of comm error on the backplane

bit 3=Error, Slot nbr entered is same as PLC's slot nbr

bits 2-1(msb)=unused.

4xxxx+1=State of inputs 1-16 at time of interrupt.

4xxxx+2=Reserved for future use.

4xxxx+3 to 4xxxx+3+bottom node number:

bits 1-5=interrupt line status (see zoom screen);

bit 6=unused;

bits 7-16: Subroutine LAB number (0-1023);

Value of zero (0), means interrupt ignored.

BOTTOM NODE (number 1-16)

Highest interrupt line to use. Maximum nbr of interrupts that come from the module. Sets implied 4xxxx range, (see above).

ICMP

The Input Compare compares bit for bit the feedback data of live inputs to the expected status of each point in its table.

When the top input receives power, a validation check is performed and if it passes data moves and mask operations are performed. When the middle input receives power, it tells the function all previous ICMP's were all good.

A value of zero in the ID numbers causes the error output to energize. A value > 9999 in Machine ID or Profile ID cause an error. A value > bottom constant in the Steps used register also cause an error.

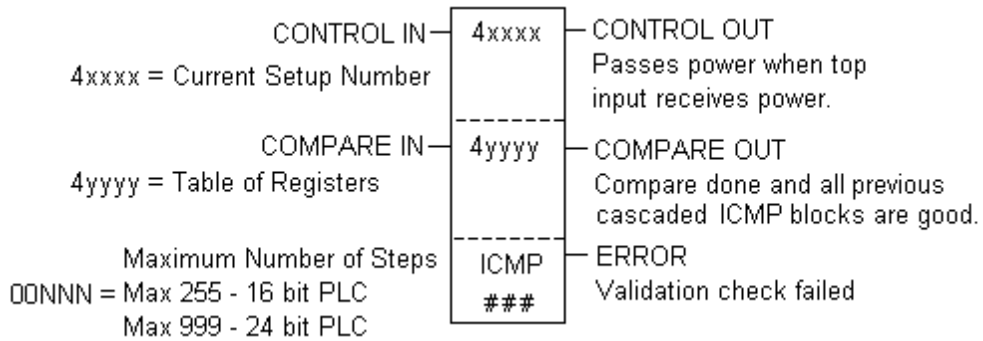

NEQN

The Network Equation allows a complex equation using algebraic notation. The instruction NEQN that represents the equation must be placed at row 0 column 1. Specific logic can accompany this instruction, which uses one full ladder logic network. The NEQN is standard in Quantum PLCs with Executive 2.0 or greater; unavailable in earlier Quantums and for other PLC types.

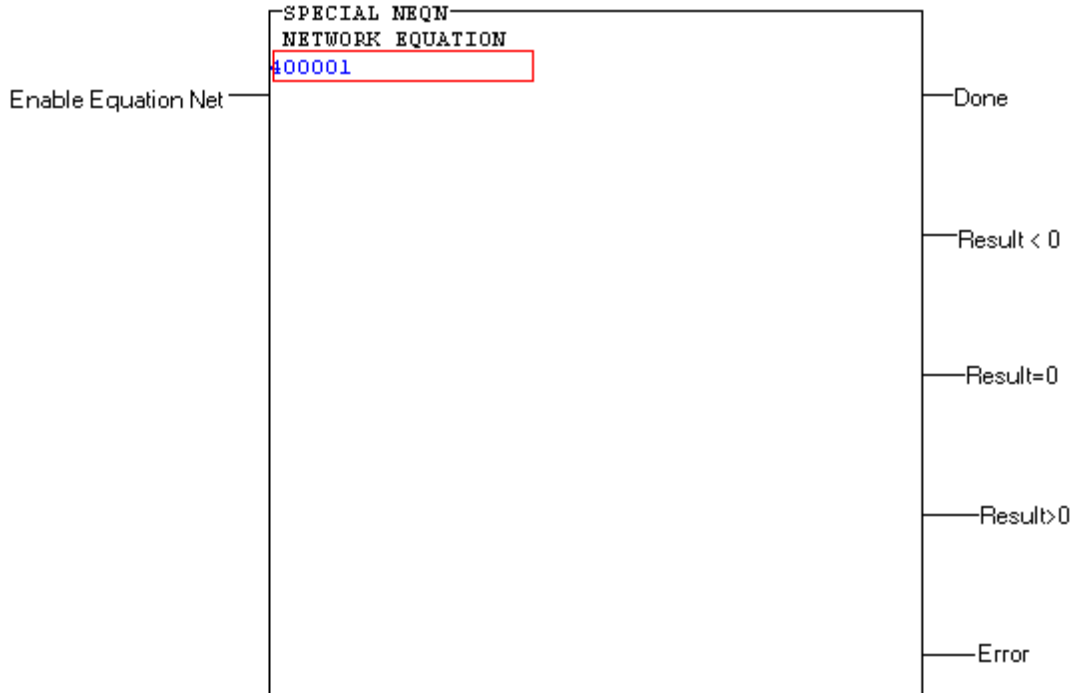

Input:

NEQN has one control input (to the top row), which is used to enable or disable the equation. The input may be a normally open (N.O.) contact, a normally closed (N.C.) contact, a horizontal short, or an open.

Outputs:

The outputs are coils in the NEQN. The row in determines their meanings. When the NEQN passes power to the output:

On the top row, the equation has completed successfully without an error.

On the second row, the equation has completed successfully and the result is less than zero.

On the third row, the equation has completed successfully and the result is equal to zero.

On the fourth row, the equation has completed successfully and the result is greater than zero.

On the fifth row, the data in the equation has caused a calculation error.

Equation Content:

The content of the Equation Network is in the form:

result: = algebraic expression

Where:

The result is a variable contained in one or two 4x registers-it may be a signed or unsigned 16-bit short integer, a signed or unsigned 32-bit long integer, or a floating point number.

The algebraic expression is a syntactically correct construction of variable and/or constant data, standard algebraic operators, and/or functions; parentheses can be used to define the order in which the expression is evaluated and to indicate arguments to functions within the expression.

If the fifth output goes ON, it indicates an error condition. One of the following messages will appear at the bottom of the Equation Network instruction:

Error Message	Meaning
Invalid Op.	An internal error generated by the math coprocessor.
Overflow	A value is too large to be represented in its specified data type.
Underflow	(For floating point data only.) A number is too small to be represented in FP format.
Divide by 0	The variable, constant, or result of a function directly to the right of a “/” operator has a value of zero.
Invalid operation with Boolean Data	Occurs when a Boolean value is entered in an argument to a function.

Data Type	Suffix	Applies to
Boolean (binary)	B	Constants, 1x, or 0x
Unsigned short integer	U	Constants, 3x, or 4x
Signed short integer	S	Constants, 3x, or 4x
Signed long integer	L	Constants, 3x, or 4x
Unsigned long integer	UL	Constants, 3x, or 4x
Floating point number	F	Constants, 3x, or 4x

When entering a 0x or 1x reference as a discrete variable the reference is assumed to be Boolean and you do not need to append the suffix B.

When entering a 3x or 4x register in NEQN the following rules apply:

If you enter a register without a suffix, it is assumed to represent a signed 16-bit integer variable.

The suffix B cannot be appended to a 3x or 4x register entry.

Algebraic Operators:

Operation Groupings	Operator Symbol	Description
Unary	-	Negation
Unary	-	One's complement
Exponent	**	Exponentiation
Multiply	*	Multiplication
Multiply	/	Division
Addition	+	Addition
Addition	-	Subtraction
Logical Bitwise	&&	AND
Logical Bitwise		OR
Logical Bitwise	<<	Left shift
Logical Bitwise	>>	Right shift
Logical Bitwise	^	XOR
Relational	<	Less than
Relational	<=	Less than or equal to
Relational	=	Equal
Relational	<>	Not equal
Relational	>=	Greater than or equal to
Relational	>	Greater than
Conditional	? x : y	Then x Else y (required after a relational (If) argument)
Assignment	:=	Placed between the result and the expression in an Equation Network; indicates that the value of the expression is copied into the result variable

The following functions are recognized in an Equation Network:

Function Name	Meaning
ABS	Absolute value
ARCCOS	Arc cosine
ARCSIN	Arc sine
ARCTAN	Arc tangent
COS	Cosine
COSD	Cosine of degrees
EXP	Exponent function (power of e)
FIX	Converts floating point to integer
FLOAT	Converts integer to floating point
LN	Natural logarithm (base e)
LOG	Common logarithm (base 10)
SIN	Sine of radians
SIND	Sine of degrees
SORT	Square root
TAN	Tangent of radians
TAND	Tangent of degrees

Data Type	Words Consumed	Valid Range of Values
Boolean	One	0, 1
Signed 16-bit constant	One	-32,768...+32,767
Unsigned 16-bit constant	One	0...65,535
Signed long (32-bit) constant	Two	-2xE9...+2xE9
Unsigned long (32-bit) constant	Two	0...4,294,967,295
Floating Point constant	Two	$8.43 \times 10^{-37} \leq x \leq 3,402 \times 10^{38}$

Entering Constant Data in an Equation Network:

A constant is prefaced with a # sign and appended with a data-type suffix. All constant values are in decimal format-hexadecimal values are not allowed.

If a constant is entered in an Equation Network without an appended suffix, it is assumed to be a signed short integer.

A Boolean constant must have the suffix B appended to it. The only two valid Boolean constants are #OB and #1B; no other values are legal Boolean constants.

21 - FTLogger/FTTrend

FTLogger Overview

FTLogger collects data from multiple PLC devices and records it in to selected database files.

FTLogger accesses the devices through FasTrak or OPC Data Access (Version 2.05 and below) communication servers. Addresses are entered in a spreadsheet format with up to 30,000 addresses per log window. Data is logged based on a specific time frame, deadband, or event.

FTTrend Overview

FTTrend is an application that enables graphical trending of real-time and logged data from multiple devices. A data trend is illustrated by graphing a series of data values collected for a data point over a period of time. A line connects the values to each other. The real-time access to devices is handled through FasTrak or OPC Data Access (Version 2.05 and below) communication servers and the logged data comes from a Microsoft Access or SQL database file created by FTLogger or FTTrend.

22 - Auditing

Activity Audit

The Activity Audit contains records that list programming and setting changes made by users while running WorkShop. These records contain:

The date and time the activity occurred

A general description of the activity

The machine name of the computer on which the activity occurred

When available, the name of the user who performed the activity

Examples of particular Audit activities that may be recorded in the Activity Audit file include:

Each time PLC WorkShop attaches online to a PLC

Whenever logic is changed in the ladder program

PLC memory configuration is modified

Activity Audits can be written to Microsoft Access files, Structured Query Language (SQL) files or the Windows Activity Log (when the FT Security Server is running on an accessible computer).

For more on the FT Security Server, please see Chapter 5 of this manual.

Activity Audits written to Microsoft Access and SQL files may be read with many popular viewers.

Audits written to the Windows Activity Logs may be read with the **Windows Event Viewer**, which is found in the Windows NT/2000/XP **Administrative Tools** menu.

The Activity Audit feature may be used in conjunction with Password Security but can also be used independently.

Setup

Select the **Options / Activity Audit Setup** menu item as illustrated below to setup the activity audit.



If security is not enabled, the Activity Audit Setup option is not protected and any user can access this feature.

When security is enabled, WorkShop determines under which operating system it is running. If WorkShop is running under Windows 95/98/ME, the Password Required dialog appears.



This dialog verifies the entered **Name** and **Password** are those of an administrator. Only an Administrator is allowed to edit / enable audits when security is enabled.

INDEX

484 mode	289	Compatibility	2
911 Status	171	Configuration.....	240
984 State.....	170	Configuration Extensions.....	129, 133, 148
984 Status.....	173	configurator.....	124, 487
Address Documentation	18	Configuring the TCP/IP Extension	156
Addresses.....	129, 220	Connecting to PLC.....	17
administrator	122	Control.....	233
Animation Editor	261	Controller State	169
ASCII Input.....	133	Controller Status	172
ASCII Message Editor.....	210	CONV	435
ASCII Message Status.....	179	Copy.....	5, 13, 15, 210, 221
ASCII Output	133	Counters	346, 410, 437
ASCII Ports.....	129, 133, 138, 148	Creating	
audit	487	New Program	11, 13, 241, 129
audit trail.....	113, 487	Cross Reference	13, 34, 233, 240
audits.....	117, 124	Cursor Type	16
authentication.....	105	Customer Support.....	1
Battery Coil.....	133	Cut.....	2, 13, 197, 221
BLKT	403	Data format.....	210, 220, 232
branch.....	51	Data Link.....	105
Cable A Errors.....	187	Data Protection	148
Cable B Errors	189	Data Window.....	2, 13, 51, 52, 220
Call instruction.....	404	DCOM.....	118
centralized security	122, 124	DCP Drop ID	133
centralized security server	118	Debug	237
Changing PLC Types	130	Delete.....	198, 221
Channels.....	133	DIO Health.....	195
CKSM.....	403	Disabling data	226
Clear.....	210, 221, 240	Discrete Inputs	133
Clearing Memory	240	Discrete Outputs.....	133
Coils	210, 270	Documentation	16, 240
Column.....	51, 223	Documentation Window	13, 16
Communication Status	183	Domains	115
Communications Cable	7	Drop Communication Errors	193

Duplicate Coils.....	270	I/O Scanner Transaction.....	159
DX Modules.....	133	Import Program.....	11
EARS.....	403	Importing Documentation.....	23
Edit		Input Registers.....	133
Cut.....	2	Insert.....	15, 198, 201, 210, 221, 223
Logic Editor.....	51, 52, 53	Installation.....	5, 11
New Network.....	54	Instruction.....	12, 15, 133, 197, 200
New Row.....	54	Instruction Bar.....	12, 15, 201
Paste.....	2	IP Address.....	94
Paste with Rewire.....	197, 221	Keyboard.....	138, 197, 200, 201, 221
Logic Programs.....	13, 197, 210, 221, 241	Label.....	25
EEPROM.....	131	Ladder.....	34
EMTH.....	422, 451	Ladder Editor.....	200
Enabling data.....	227	Load Program Offline.....	32, 34, 89
End of Logic Pointer.....	177	Loadables.....	129, 164
Enter and Validate.....	13	Logger.....	485
EPROM.....	131	Logic Programs	
Error Log.....	105	Creating.....	13
EUCA.....	403	Debugging.....	238
Exporting.....	11	documenting.....	240
Exporting Documentation.....	25	Programming.....	197, 221, 226, 233, 240
Fast PLC Connection.....	17, 18, 97	Saving.....	13
Fast PLC Setup.....	18, 89, 97	Logic Status.....	239
Find Logic.....	13, 215, 216	Logical AND Function.....	314
Flash RAM.....	131	Logical Complement.....	320
Floating.....	16	Login.....	237
FN10.....	403	Logout.....	237
Format.....	220	Machine Configuration.....	168
FTLogger.....	485	MAP3.....	403
FTTrend.....	485	Maximum Messages.....	133
Global Errors.....	191	MBUS.....	403
groups.....	115, 124	Menu Bar.....	12, 13
Holding Registers.....	133	Merge Program Choice Dialog.....	56
Hot keys.....	202	Merge Program Procedure.....	54
HSBY.....	403	MMS ETHERNET.....	157

Modbus Ports.....	129, 133, 139	Powerflow	197
Mode.....	240	Print	
Module Health	182	Page Setup	89
Modules.....	144	Cross Reference.....	233
Mouse.....	2, 197, 200, 201	Printer Setup	99
MOVE.....	44, 201	Printing Logic.....	34
MSTR.....	403	Printer Setup	89, 99
Network	200, 222	Processor Status	236
Network Communications.....	93	Program Setup.....	2, 89, 241
Network Headers	241	Program Windows	15
Network Scan.....	96	Programming	
New Network.....	54	Offline	16, 197, 226, 233, 240
New Program.....	129	Online.....	16, 197, 233, 240
Normally Open Contacts	239	Quantum Hot Standby.....	154
NOT.....	2, 32, 95	Quantum VME Bus Configuration	
Number Lock.....	16	Extension	153
Number of Segments	176	RAM.....	131
Open.....	32, 34, 89	Remote I/O Timeout.....	178
Optimize	237	Replace Table.....	46
Page Setup	89	Row	13, 201, 210, 223
Password.....	105, 122	RT*TI	435
Password Security.....	105, 113	RT*TO	435
Paste.....	2, 13, 15, 197, 221	Run Mode.....	237, 240
Paste with Rewire	197, 221	Run Status	180
PCFL	232, 451	S901 Status	174
Peer Cop	148	S908 Error.....	185
PEER.....	415	S980 Station Address.....	148
PID	416	SA85 board CONFIG.SYS file	93
PID2.....	403	Save Program As.....	240
PLC Clock and Calendar.....	133	Save Program As Offline.....	32
PLC Configuration.....	133, 139, 148, 240	Saving.....	13, 221
PLC Operations.....	237	Saving Logic Programs.....	32
PLC Type Setup.....	129, 133	Searching for an Address.....	248
PLC Types	130	Security 105, 113, 115, 117, 118, 122, 124, 487	
Pop.....	223	Security Congifuration	122

Segment.....	198	Terminal Modem	91
Segment Headers	241	TEST.....	333, 346, 361, 367
Segment Scheduler	198	Timer Register	133
Selection.....	198	Timers	198, 437
Sequencers	281, 435	Title Bar	12, 197
Server.....	113	Toolbar	2, 12, 13, 15, 17, 18, 30, 31, 197, 200, 214, 226, 233
Set Clock.....	129, 165	Total Config. Ext. Words	133, 148
Setup		Total Logic Words.....	133
Communications	93	Total Message Words	133
PLC Type.....	129, 133	Total TCOP Words	133
Printer.....	89, 99	Trace Coil.....	218
Program	89, 241	Transfer Offline Program to Online.....	22
Share Address Documentation	18	Trend.....	485
SKIP	133	TTR.....	435
Square D	144	Undo	50
Status Line	12, 13, 16, 201	Users	115, 124
Status Pointer	181	Using the ASCII Message Editor	210
Stop Code	175	Using the Logic Editor.....	51, 52, 53
SubNet Mask.....	94	Validate and Enter Logic	197, 226, 233
Support.....	1	Watchdog Timer	133
SY/MAX	144	Workgroup.....	115
SY/MAX Configuration Extension	157	Zoom	
Symbols.....	18, 31, 34, 233, 240	PCFL Instruction EQN Function	232
Table Update.....	233	variable.....	231
TBLK	403	Zoomable Instructions.....	230
Technical Support	1		